



an *ArvinMeritor* brand



MEDIUM / HEAVY-DUTY TRUCK PARTS

FRONT END

FOR TRUCKS / TRACTORS / SCHOOL BUSES



THE MOST TRUSTED NAME IN TRUCK PARTS.

Catalog 760C

CONTENTS

CATALOG 100B

Foundation Air Brakes
Air System Parts

Section 1
Section 2

CATALOG 200

Hydraulic Brake Parts

Section 3

CATALOG 100B (Cont'd.)

Friction Material
Wheel and Hub Parts
Service Tools
Miscellaneous Products

Section 4
Section 5
Section 6
Section 7

CATALOG 700C

Suspension Parts

Section 8

CATALOG AFTCAT014

Air Spring Replacement Guide

Section 9

CATALOG 754

Shock Absorbers

Section 10

CATALOG 760C

FRONT END PARTS

Section 11

CATALOG 800C

Air Conditioning and Heating Parts

Section 12

CATALOG 820A

Electrical Parts
Water Pumps

Section 13
Section 14

REFERENCE - CATALOG 760C

MASTER PART INTERCHANGE/NUMBER INDEX

Section M

MASTER INTERCHANGES - (SEE CATALOG 980)

CONTENTS

CATALOG 100B	
Section 1 - AIR BRAKE PARTS	
Section 2 - AIR SYSTEM PARTS	
CATALOG 200	
Section 3 - HYDRAULIC BRAKE PARTS	
CATALOG 100B (Cont.)	
Section 4 - FRICTION MATERIAL	
Section 5 - WHEEL AND HUB PARTS	
Section 6 - SERVICE TOOLS	
Section 7 - MISCELLANEOUS PRODUCTS	
CATALOG 700C	
Section 8 - SUSPENSION PARTS	
CATALOG AFTCAT014	
Section 9 - AIR SPRINGS	
CATALOG 754	
Section 10 - SHOCK ABSORBERS	
CATALOG 760C	
SECTION 11 - FRONT END PARTS	
Product Codes	iii
Front Axle Exploded View	iv
Notice	iv
King Pin Kit Identification Photos	iv
How to Use I.D. Charts	vi
IDENTIFICATION CHARTS	
Crosstubes	11-16
Drag Links Listed by Length	11-11
Drag Links Listed by Part Number	11-16
King Pin Bushings:	
Bushings to Kit	11-6
Kit to Bushings	11-5

CATALOG 760C (Continued)	
IDENTIFICATION CHARTS (Continued)	
King Pin Kit Identification - Straight Type	11-1
King Pin Kit Identification - Tapered Type	11-4
Shims by I.D.	11-7
Tie Rod and Drag Link Ends	11-8
APPLICATION LISTING BY MAKE AND MODEL	
How To Use Application Charts	11-18
Dana/Spicer	11-19
Eaton	11-22
Ford	11-24
Freightliner	11-59
GMC/Chevrolet	11-63
Kenworth	11-104
Mack	11-114
Meritor	11-128
Navistar	11-140
Peterbilt	11-173
Volvo	11-178
Western Star	11-184
Westport	11-186
White	11-188
CATALOG 800C	
Section 12 - AIR CONDITIONING & HEATING PARTS	
CATALOG 820A	
Section 13 - ELECTRICAL PARTS	
Section 14 - WATER PUMPS	
CATALOG 760C - REFERENCE	
SECTION M - REFERENCE - CATALOG 760C	
INTERCHANGE	M-1
MASTER PART NUMBER INDEX	M-25
WARRANTY	M-70
CATALOG 980 - MASTER INTERCHANGE	
	

PRODUCT CODES

Euclid Product Codes group part numbers by product line. Product Codes are separate and distinct from the Euclid part numbers and will appear on price sheets, catalogs, shippers and invoices for reference only. Euclid WDs may decide whether or not they will utilize the Product Codes in their own operations.

- Product Codes are useful in:
- Part application identification
 - Warehouse layout organization
 - Inventory control
 - Sales analysis

PRODUCT CODE	DESCRIPTION	PRODUCT CODE	DESCRIPTION
AIR BRAKE PARTS		SUSPENSION PARTS	
101	Brake Repair Kits	701	Hendrickson
103	Camshafts	702	Reyco
104	Camshaft Repair Kits	703	Hutchens
105	Camshaft Hardware	704	Freightliner
107	Manual Slack Adjusters	705	Mack
108	Automatic Slack Adjusters	706	Spicer (Dana/Webb)
109	Brake Shoes - Unlined and Brake Shoe Bushings	707	Dayton
110	Foundation Air Brake Hardware	708	Fruehauf
112	Brake Spiders and Dust Shields	709	Neway
120	Tools	710	Page
130	Air Brake Hose and Fittings	711	Trailmobile
131	Spring Brakes and Air Chamber Parts	712	Transpro
140	Bendix Wedge Brake Parts	713	Chalmers
141	Meritor Stopmaster Wedge Brake Parts	714	Kenworth
149	Miscellaneous Air Brake Parts	715	Peterbilt
150	Air Compressors	716	Navistar International (IHC)
151	Air Valves	717	Hendrickson Turner
152	Air Dryers and Miscellaneous	718	Kwik-Loc (Jifflox)
153	Components and Kits	719	Volvo White
197	Air Brake Cores	720	Ridewell
199	Air Brake Clearance Parts	721	Binkley
HYDRAULIC BRAKE PARTS		723	Granning
201	Hydraulic Drum Brake Hardware	725	Meritor
202	Hydraulic Disc Brake Hardware	740	Torque Arms and Torque Arm Parts
203	Wheel Cylinders/Kits	741	U-Bolt Assemblies, Hi-Nuts and Washers
204	Master Cylinders/Kits	742	Spring Center Bolts
205	Clutch Cylinders/Kits	748	Specialty Polyurethane Products
206	Calipers	749	Miscellaneous Suspension Parts
207	Rotors	751	Air Springs
208	Hydraulic Hose/Steel Lines	754	Gabriel Shock Absorbers
209	Hydraulic Brake Shoes	799	Suspension / Front End Clearance Parts
210	Remanufactured Calipers	FRONT END PARTS	
211	Remanufactured Brake Boosters	760	King Pin Kits, Bushings and Shims
248	Miscellaneous Hydraulic Brake Parts (includes Brake Fluid and Bleeder Ball)	761	Tie Rod Ends
297	Caliper/Cylinder Cores	762	Drag Links and Drag Link Ends
299	Hydraulic Clearance Parts	AIR CONDITIONING and HEATING PARTS PROGRAM	
FRICITION MATERIAL		801	Compressors and Compressor Bracket Kits
301	Non-Asbestos Brake Block	802	Clutches
306	Non-Asbestos Brake Lining	803	Blower Motors, Blower Wheels and Fan Blades
310	Hydraulic Disc Pads	804	Receiver Driers, Accumulators and Moisture Indicators
320	Lined Brake Shoes	805	Expansion Valves
325	Shoe Box Kits	806	Heater Valves
330	Brake Block Bolts and Rivets	807	Electrical Switches
398	Miscellaneous Friction Parts	808	Fittings, Service Valves and Hose
399	Friction Clearance Parts	810	Condenser Cores
WHEEL ATTACHING PARTS		811	Evaporator Cores
501	Drive Flange Studs, Nuts and Wedges	812	Heater Cores
503	Spoke Wheel Studs and Nuts	813	Tools, Service Items and Equipment
504	Disc Wheel Studs and Nuts	814	Chemicals, Refrigerants and Lubricants
507	Rim Clamps	ELECTRICAL AND WATER PUMPS	
509	Axle Spindle Nuts and Washers	820	Alternators
510	Brake Drums	821	Starters
511	Wheel Hubs, Hub Caps, Seals and Gaskets	822	Electrical Parts and Accessories
513	Trailer Axles	823	Water Pumps
520	Bearings	824	Fan Clutches
521	Seals	897	Electrical and Water Pump Cores
598	Miscellaneous Wheel Parts	CARGO RESTRAINT SYSTEMS	
599	Wheel Clearance Parts	850	Ancra
DRIVELINE PARTS			
551	Universal Joint Kits		
553	Center Bearings		

TYPICAL FRONT AXLE COMPONENTS

This exploded view represents a typical front axle assembly. The page numbers listed by the labels indicate the page where the listings for that part begin.

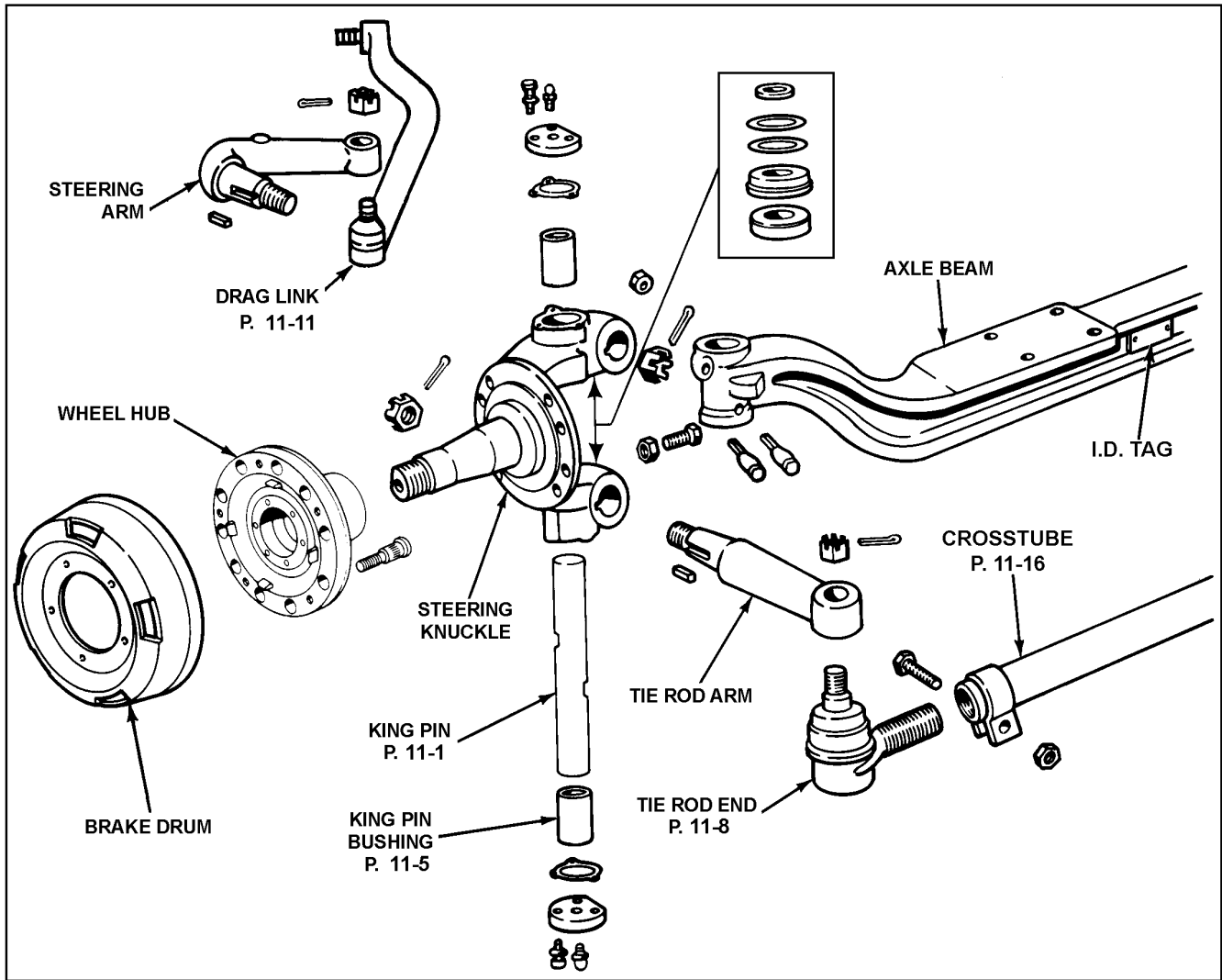

NOTICE

DISCLAIMER NOTICE

The use in this catalog of the names of manufacturers and their product numbers and descriptions is for the assistance of our customers in identifying replacement parts, some of which Euclid obtains from the original manufacturer and other of which Euclid has made by its suppliers. Names referenced in this catalog may be trademarks or trade names of manufacturers and suppliers other than Euclid Industries, LLC and there is no affiliation between Euclid Industries and such manufacturers and suppliers. Euclid's policy is to provide the best quality parts available.

Every effort has been made to insure the accuracy of the information shown in this catalog. However, Euclid Industries, LLC assumes no liability for any errors or omissions of the information provided.

EUCLID



FRONT END SECTION ELEVEN

HOW TO USE IDENTIFICATION CHARTS

KING PIN IDENTIFICATION

If only type and size of King Pin are known, refer to the Identification Charts starting on page 11-1.

A typical King Pin Kit containing the particular type of pin is shown to aid in identification.

King Pin Kits are listed in order by King Pin diameter.

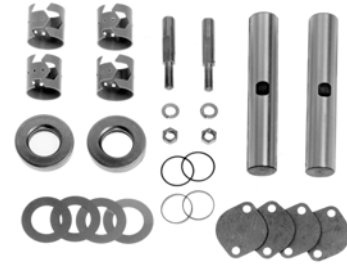
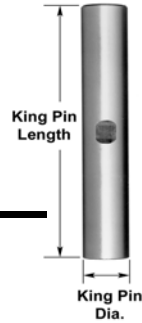

Type A

King Pin Kit Part No.	King Pin Dia.	King Pin Length	King Pin Type	Bushing Type	Bushing	Shim	Additional Contents / Notes
E-6453B	0.859"	6.670"	A	Bronze	(4) E-10185	(4) E-9220	(4) Fittings, (4) Plugs, (2) Seals, (2) Washers, (2) Lock
E-6451B	1.054"	6.685"	A	Bronze	(4) E-10186	(4) E-4572	(4) Fittings, (4) Plugs, (2) Seals, (2) Washers, (2) Lock

TIE ROD AND DRAG LINK END DIMENSIONAL IDENTIFICATION

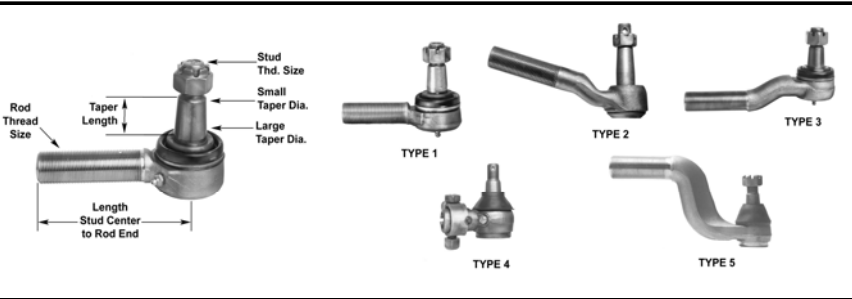

Tie Rod Ends and Drag Link Ends are listed by length.

How to measure ends is indicated by dimension lines.

Tie Rod and Drag Link End Identification Chart begins on page 11-8.

Part Number	Stud Center to Rod End	Rod Thread Size	Taper Length	Large Taper Dia.	Small Taper Dia.	Stud Thread Size	Style	Type	Industry Number	Comments
E-6774	3.12"	.75"-16 RH	.75"	.625"	.543"	.50"-20	Curbside	1	ES2847R	

DRAG LINK IDENTIFICATION

Drag Link Identification Chart is listed by length (measured from Stud Center to Stud Center).

Photos of each Drag Link provide positive identification.

Identification Chart begins on page 11-11.

Additional chart listing Drag Links by part number is on page 11-16.



Part Number	Length Stud Ctr to Stud Ctr	Large Taper Dia.	Small Taper Dia.	Taper Length	Stud Thread Size	Industry Number
E-6818	14.21"	1.25"	1.08"	1.36"	.875"-14	DS1179

INDEX

Front End Identification Charts	Page
Crosstubes	11-16
Drag Links Listed by Length	11-11
Drag Links Listed by Part Number	11-16
King Pin Bushings:	
Bushings to Kits	11-6
Kits to Bushings	11-5
King Pin Kit Identification - Straight Type.....	11-1
King Pin Kit Identification - Tapered Type.....	11-4
Shims by I.D.	11-7
Tie Rod and Drag Link Ends.....	11-8

For additional parts and information, visit our online catalog at:
www.XpresswayPlus.com

If you have any comments, suggestions or catalog corrections, please e-mail us at:
catalogfeedback@arvinmeritor.com

King Pin Kit Identification

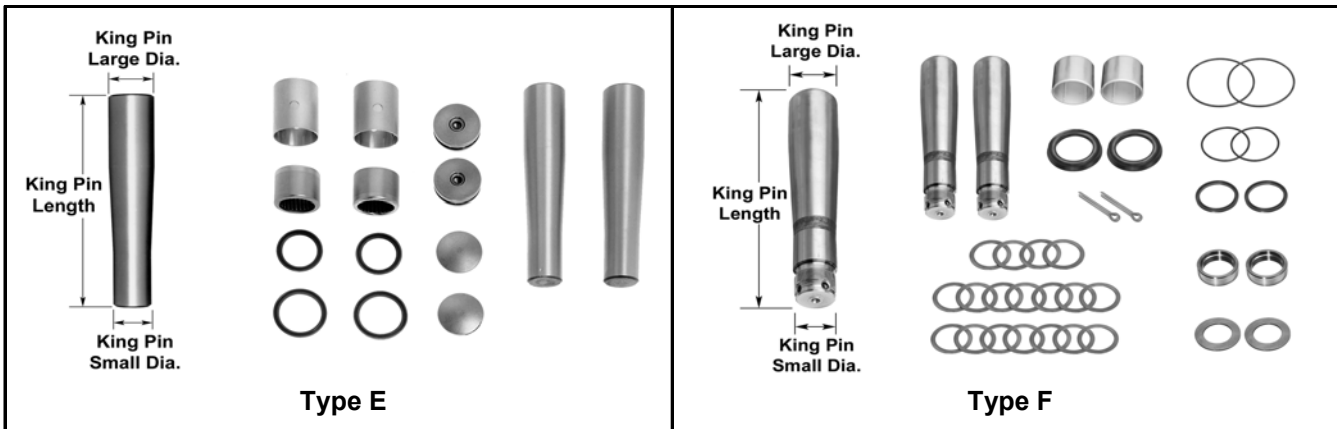
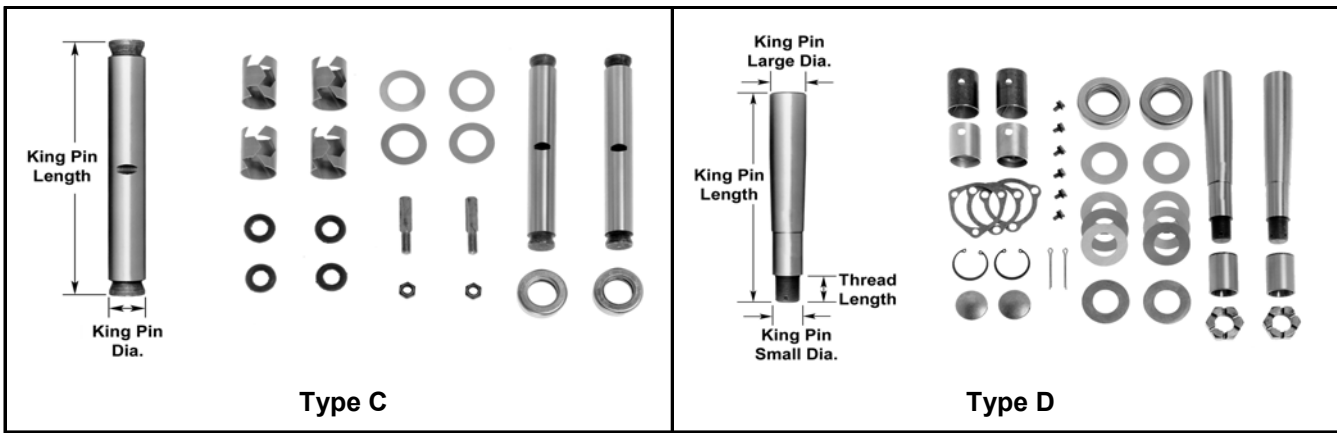
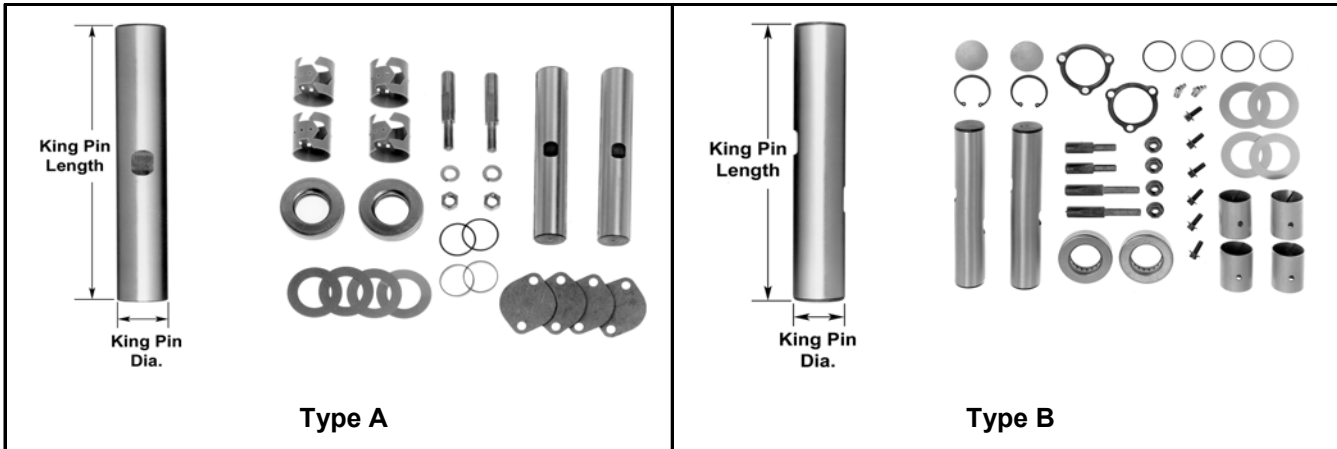

Pictures represent typical king pin kit contents. Parts may vary by application.

KING PIN KIT IDENTIFICATION - STRAIGHT TYPE

King Pin Kit Part No.	King Pin Dia.	King Pin Length	King Pin Type	Bushing Type	Bushing	Shim	Additional Contents / Notes
E-6453B	0.859"	6.670"	A	Bronze	(4) E-10185	(4) E-9220	(4) Fittings, (4) Plugs, (2) Seals, (2) Washers, (2) Lock Pins, (2) Nuts.
E-6451B	1.054"	6.685"	A	Bronze	(4) E-10186	(4) E-4572	(4) Fittings, (4) Plugs, (2) Seals, (2) Washers, (2) Lock Pins, (2) Nuts.
E-6450B	1.054"	6.969"	A	Bronze	(4) E-10186	(4) E-4572	(4) Fittings, (4) Plugs, (2) Seals, (2) Washers, (2) Lock Pins, (2) Nuts.
E-4444B	1.109"	6.343"	A	Bronze	(4) E-4513	(2) E-10170 (2) E-4575 (2) E-4576	(4) Gaskets, (2) Seals, (2) Washers, (2) Lock Pins, (2) Nuts.
E-4444N	1.109"	6.343"	A	Nylon	(4) E-4540	(2) E-10170 (2) E-4575 (2) E-4576	(2) Spacers, (2) Seals, (2) Washers, (4) Gaskets, (2) Lock Pins, (2) Nuts.
E-4430B	1.109"	6.344"	A	Bronze	(4) E-4513	(2) E-10170 (2) E-4575 (2) E-4576	(4) Gaskets, (8) Plugs, (2) Seals, (2) Washers, (2) Lock Pins, (2) Nuts.
E-6865B	1.109"	6.810"	A	Bronze		(4) E-4572	(2) Snap Rings, (2) Plugs, (4) Retainers, (2) Washers, (4) Lock Pins, (2) Nuts, (2) Felts.
E-6454B	1.179"	6.360"	A	Bronze		(12) E-4573	(4) Gaskets, (4) Seals, (2) Washers, (2) Lock Pins, (2) Nuts, (4) Bushings.
E-4453B	1.179"	6.360"	A	Bronze	(4) E-4547	(6) E-4573	(4) Gaskets, (2) Seals, (2) Washers, (2) Lock Pins, (2) Nuts.
E-6454C	1.179"	6.360"	A	Composite	(4) E-10188	(12) E-4573	(4) Gaskets, (4) Seals, (2) Washers, (2) Lock Pins, (2) Nuts.
E-4440B	1.231"	7.860"	C	Bronze	(4) E-4536	(2) E-10170 (2) E-4575 (2) E-4576	(4) Seals, (2) Lock Pins, (2) Nuts.
E-4445B	1.231"	8.910"	C	Bronze	(4) E-4541	(2) E-10170 (2) E-4575 (2) E-4576	(4) Seals, (2) Lock Pins, (2) Nuts.
E-4445N	1.231"	8.910"	C	Nylon	(4) E-4542	(2) E-10170 (2) E-4575 (2) E-4576	(4) Seals, (2) Lock Pins, (2) Nuts.
E-11815C	1.234"	6.781"	A	Composite			(4) Bushings, (8) Shims, (6) Seals, (2) Draw Keys, (2) Nuts, (4) Caps.
E-4438B	1.234"	7.438"	B	Bronze	(4) E-4531	(2) E-10170 (2) E-4575 (2) E-4576	(2) Snap Rings, (2) Plugs, (4) Screws, (2) Gaskets, (4) Lock Pins.
E-4438N	1.234"	7.438"	B	Nylon	(4) E-4532	(2) E-10170 (2) E-4575 (2) E-4576	(2) Snap Rings, (2) Plugs, (4) Screws, (2) Gaskets, (4) Lock Pins.
E-4431B	1.234"	7.656"	A	Bronze	(4) E-4514	(2) E-10170 (2) E-4575 (2) E-4576	(4) Gaskets, (2) Washers, (2) Lock Pins, (2) Nuts.
E-4443B	1.249"	7.888"	A	Bronze	(4) E-4538	(2) E-10170 (2) E-4575 (2) E-4576	(2) O-Rings, (4) Gaskets, (2) Washers, (2) Lock Pins, (2) Nuts.
E-4443N	1.249"	7.888"	A	Nylon	(4) E-4539	(2) E-10170 (2) E-4575 (2) E-4576	(2) O-Rings, (4) Gaskets, (2) Washers, (2) Lock Pins, (2) Nuts.
E-6455B	1.299"	7.270"	A	Bronze	(4) E-10195	(4) E-4577	(2) Seals, (4) Plugs, (2) Washers, (2) Lock Pins, (2) Nuts.
E-6455C	1.299"	7.270"	A	Composite	(4) E-10187	(4) E-4577	(2) Seals, (4) Plugs, (2) Washers, (2) Lock Pins, (2) Nuts.
E-6195B	1.299"	7.748"	B	Bronze	(4) E-10190	(4) E-4577	(4) Plugs, (4) Seals, (4) Lock Pins, (4) Nuts.
E-4460B	1.359"	7.968"	A	Bronze	(4) E-4555	(4) E-4577	(8) Seals, (2) Lock Pins, (2) Nuts.
E-6198B	1.359"	7.970"	B	Bronze	(4) E-4555	(4) E-4577	(4) Fittings, (8) Seals, (8) Screws, (8) Washers, (18) Lock Pins.
E-9943B	1.433"	8.250"	B	Bronze	(4) E-4546	(2) E-10172 (2) E-4579	(4) Plugs, (4) Seals, (4) Lock Pins, (4) Nuts.
E-4452B	1.433"	8.250"	B	Bronze	(4) E-4546	(2) E-10172 (2) E-4579	(2) Fittings, (2) Snap Rings, (2) Plugs, (2) Gaskets, (4) Seals, (6) Screws, (4) Lock Pins, (4) Nuts.
E-4441B	1.434"	8.500"	B	Bronze	(4) E-4523	(2) E-10172 (2) E-4579	(2) Snap Rings, (2) Gaskets, (2) Plugs, (6) Screws, (4) Lock Pins.

KING PIN KIT IDENTIFICATION - STRAIGHT TYPE

King Pin Kit Part No.	King Pin Dia.	King Pin Length	King Pin Type	Bushing Type	Bushing	Shim	Additional Contents / Notes
E-4448B	1.480"	8.866"	B	Bronze	(4) E-4543	(2) E-10172 (2) E-4579	(4) Gaskets, (12) Screws, (12) Washers, (4) Lock Pins.
E-4461B	1.484"	8.866"	A	Bronze	(4) E-4543	(2) E-10172 (2) E-4579	(4) O-rings, (4) Seals, (12) Screws, (12) Washers, (2) Lock Pins, (2) Nuts.
E-11816C	1.498"	7.153"	B	Composite			(4) Bushings, (4) Shims, (6) Seals, (4) Draw Keys, (4) Nuts, (4) Caps.
E-11812C	1.499"	7.511"	B	Composite			(4) Bushings, (4) Shims, (6) Seals, (4) Draw Keys, (4) Nuts, (4) Caps, (4) Fittings.
E-4449B	1.607"	8.740"	B	Bronze	(4) E-4519	(2) E-10167 (2) E-10171 (2) E-4580	(2) Snap Rings, (2) Plugs, (2) Gaskets, (4) Screws, (4) Lock Pins.
E-6197B	1.607"	9.080"	B	Bronze	(4) E-4552	(2) E-10167 (2) E-10171 (2) E-4580	(4) Plugs, (4) Seals, (4) Lock Pins, (4) Nuts.
E-4457B	1.607"	9.080"	B	Bronze	(4) E-4552	(2) E-10167 (2) E-10171 (2) E-4580	(2) Fittings, (2) Snap Rings, (2) Plugs, (2) Gaskets, (4) Seals, (6) Screws, (4) Lock Pins, (4) Nuts.
E-4595B	1.607"	9.375"	B	Bronze	(4) E-5450	(2) E-10167 (2) E-10171 (2) E-4580	(4) Fittings, (4) Gaskets, (6) Seals, (12) Screws, (12) Washers, (12) Lock Pins.
E-4463B	1.609"	9.160"	A	Bronze	(4) E-4544	(2) E-10167 (2) E-10171 (2) E-4580	(8) Seals, (12) Screws, (12) Washers, (2) Lock Pins, (2) Nuts.
E-4697B	1.609"	9.160"	B	Bronze	(4) E-4544	(2) E-10167 (2) E-10171 (2) E-4580	(4) Seals, (4) O-Rings, (4) Lock Pins.
E-4462B	1.609"	9.660"	A	Bronze	(4) E-4544	(2) E-10167 (2) E-10171 (2) E-4580	(8) Seals, (12) Screws, (12) Washers, (4) Lock Pins, (2) Nuts.
E-4693B	1.609"	9.660"	B	Bronze	(4) E-4544	(2) E-10167 (2) E-10171 (2) E-4580	(6) Fittings, (2) O-Rings, (4) Gaskets, (4) Seals, (12) Screws, (12) Washers, (10) Lock Pins.
E-4451B	1.609"	9.660"	B	Bronze	(4) E-4544	(2) E-10167 (2) E-10171 (2) E-4580	(4) Gaskets, (8) Seals, (12) Screws, (12) Washers, (4) Lock Pins.
E-6875C	1.609"	9.660"	B	Composite	(4) E-10191	(2) E-10167 (2) E-10171 (2) E-4580	(6) Fittings, (4) Seals, (4) O-Rings, (12) Screws, (18) Lock Pins.
E-10104B	1.614"	8.035"	D	Bronze			(2) Bushings, (2) Gaskets, (4) Seals, (2) Nuts.
E-4696B	1.625"	9.195"	A	Bronze	(4) E-10192	(2) E-10176 (2) E-10177	(4) Fittings, (4) Gaskets, (2) Seals, (12) Screws, (12) Washers, (2) Lock Pins, (2) Nuts.
E-6869C	1.625"	9.195"	A	Composite	(4) E-5446	(2) E-10176 (2) E-10177	(4) Fittings, (4) Gaskets, (2) Seals, (12) Screws, (12) Washers, (2) Lock Pins, (2) Nuts.
E-4696C	1.625"	9.195"	A	Composite	(2) E-5446	(2) E-10176 (2) E-10177	(4) Fittings, (4) Gaskets, (2) Seals, (12) Screws, (12) Washers, (2) Lock Pins, (2) Nuts.
E-4469B	1.745"	9.380"	B	Bronze	(4) E-4563	(2) E-10168 (2) E-10169 (2) E-4581	(2) Snap Rings, (2) Plugs, (4) Gaskets, (4) Seals, (8) Lock Pins.
E-11808C	1.794"	8.844"	B	Composite			(4) Bushings, (4) Shims, (4) Seals, (4) Draw Keys, (4) Nuts, (4) Caps, (4) Fittings.

KING PIN KIT IDENTIFICATION - STRAIGHT TYPE

King Pin Kit Part No.	King Pin Dia.	King Pin Length	King Pin Type	Bushing Type	Bushing	Shim	Additional Contents / Notes
E-4442B	1.794"	9.120"	B	Bronze	(4) E-4534	(2) E-10168 (2) E-10169 (2) E-4581	(2) Retainers, (2) Snap Rings, (2) Plugs, (2) Gaskets, (6) Screws, (4) Lock Pins.
E-6196B	1.794"	10.070"	B	Bronze	(4) E-4554	(2) E-10168 (2) E-10169 (2) E-4581	(4) Plugs, (4) Seals, (4) Lock Pins, (4) Nuts.
E-4459B	1.794"	10.070"	B	Bronze	(4) E-4554	(2) E-10168 (2) E-10169 (2) E-4581	(4) Fittings, (4) Gaskets, (4) Seals, (12) Screws, (4) Lock Pins, (4) Nuts.
E-4459C	1.794"	10.070"	B	Composite	(4) E-5445	(2) E-10168 (2) E-10169 (2) E-4581	(4) Fittings, (4) Gaskets, (4) Seals, (12) Screws, (4) Lock Pins, (4) Nuts.
E-6868B	1.794"	10.392"	B	Bronze	(4) E-4545	(2) E-10168 (2) E-10169 (2) E-4581	(4) Fittings, (4) Gaskets, (6) Seals, (12) Screws, (12) Washers, (4) Lock Pins, (4) Nuts. No lubrication fitting. Special seal and thrust bearing T-1921.
E-6199B	1.794"	10.392"	B	Bronze	(4) E-4545	(2) E-10168 (2) E-10169 (2) E-4581	(4) Fittings, (4) Gaskets, (4) Seals, (12) Screws, (12) Washers, (4) Lock Pins, (4) Nuts.
E-4468B	1.794"	10.392"	B	Bronze	(4) E-4545	(2) E-10168 (2) E-10169 (2) E-4581	(2) Fittings, (2) Snap Rings, (2) Plugs, (2) Gaskets, (4) Seals, (6) Screws, (2) Washers, (4) Lock Pins, (4) Nuts.
E-11809C	1.794"	10.392"	B	Composite			(4) Bushings, (8) Shims, (4) Seals, (4) Draw Keys, (4) Nuts, (4) Caps, (4) Fittings, (12) Washers, (12) Capscrews, (4) Gaskets.
E-6199C	1.794"	10.392"	B	Composite	(4) E-5445	(2) E-10168 (2) E-10169 (2) E-4581	(4) Fittings, (4) Gaskets, (6) Seals, (12) Screws, (12) Washers, (4) Lock Pins, (4) Nuts.
E-4695C	1.794"	10.392"	B	Composite	(4) E-5445	(2) E-10168 (2) E-10169 (2) E-4581	(4) Fittings, (4) Gaskets, (6) Seals, (12) Screws, (12) Washers, (4) Lock Pins, (4) Nuts. No lubrication fitting. Special seal and thrust bearing T-1921.
E-4694C	1.794"	10.392"	B	Composite	(4) E-5445	(2) E-10168 (2) E-10169 (2) E-4581	(4) Fittings, (4) Gaskets, (4) Seals, (12) Screws, (12) Washers, (4) Lock Pins, (4) Nuts.
E-11810C	1.794"	10.392"	B	Composite			(4) Bushings, (8) Shims, (6) Seals, (4) Draw Keys, (4) Nuts, (4) Caps, (12) Washers, (12) Capscrews, (4) Gaskets.
E-11811C	1.794"	10.392"	B	Composite			(4) Bushings, (8) Shims, (4) Seals, (4) Draw Keys, (4) Nuts, (4) Caps, (4) Fittings, (12) Washers, (12) Capscrews, (4) Gaskets.
E-4450B	1.794"	10.410"	B	Bronze	(4) E-4545	(2) E-10168 (2) E-10169 (2) E-4581	(4) Gaskets, (2) Seals, (12) Screws, (4) Lock Pins.
E-9945B	1.810"	10.531"	A	Bronze	(4) E-4564		(6) Shims, (4) Fittings, (4) Caps, (4) Seals, (4) Lock Pins, (4) Nuts.
E-4471B	1.810"	10.531"	A	Bronze	(4) E-4564	(2) E-10173 (2) E-4582	(2) Gaskets, (2) Seals, (2) Lock Pins.
E-4470B	1.810"	10.531"	A	Bronze	(4) E-4564	(2) E-10173 (2) E-4582	(2) Gaskets, (2) Seals, (2) Lock Pins.
E-4598B	1.810"	10.781"	A	Bronze	(4) E-4564	(2) E-10173 (2) E-4582	(4) Gaskets, (2) Washers, (2) Lock Pins, (2) Nuts.
E-6194B	1.873"	9.965"	A	Bronze	(4) E-10196	(2) E-10174 (2) E-10175 (2) E-4583	(4) Fittings, (4) Seals, (16) Screws, (16) Washers, (2) Lock Pins, (2) Nuts.
E-6194C	1.873"	9.965"	A	Composite	(4) E-10189	(2) E-10174 (2) E-10175 (2) E-4583	(4) Fittings, (2) Seals, (16) Screws, (16) Washers, (2) Lock Pins, (2) Nuts.

KING PIN KIT IDENTIFICATION - STRAIGHT TYPE

King Pin Kit Part No.	King Pin Dia.	King Pin Length	King Pin Type	Bushing Type	Bushing	Shim	Additional Contents / Notes
E-10105B	1.892"	9.188"	D	Bronze			(2) Bushings, (2) Gaskets, (4) Seals, (2) Nuts.
E-10106B	1.892"	9.594"	D	Bronze			(2) Bushings, (2) Gaskets, (4) Seals, (2) Nuts.
E-9312B	1.906"	9.125"	B	Bronze	(4) E-10184	(2) E-10168 (2) E-10169 (2) E-4581	(2) Rings, (2) Plugs, (2) Gaskets, (6) Screws, (4) Lock Pins.
E-9941B	1.921"	9.87"	B	Bronze	(4) E-10193		(6) Shims, (4) Fittings, (6) Seals, (4) Lock Pins, (4) Nuts, (4) O-Rings.
E-4454B	1.999"	11.040"	B	Bronze	(4) E-4549	(2) E-10174 (2) E-10175 (2) E-4583	(2) Snap Rings, (2) Plugs, (2) Gaskets, (6) Screws, (4) Lock Pins.
E-4454N	1.999"	11.040"	B	Nylon	(4) E-4550	(2) E-10174 (2) E-10175 (2) E-4583	(2) Snap Rings, (2) Plugs, (2) Gaskets, (6) Screws, (4) Lock Pins.
E-4458B	1.999"	11.212"	B	Bronze	(4) E-4553	(2) E-10174 (2) E-10175 (2) E-4583	(4) Fittings, (4) Gaskets, (6) Seals, (12) Screws, (4) Lock Pins, (4) Nuts.
E-11813C	1.999"	11.212"	B	Composite			(4) Bushings, (10) Shims, (6) Seals, (4) Draw Keys, (4) Nuts, (4) Caps, (4) Fittings, (12) Washers, (12) Capscrews, (4) Gaskets.
E-11814C	1.999"	11.212"	B	Composite			(4) Bushings, (10) Shims, (6) Seals, (4) Draw Keys, (4) Nuts, (4) Caps, (4) Fittings, (12) Washers, (12) Capscrews, (4) Gaskets.
E-4458C	1.999"	11.212"	B	Composite	(4) E-5442	(2) E-10174 (2) E-10175 (2) E-4583	(4) Fittings, (4) Gaskets, (6) Seals, (12) Screws, (4) Lock Pins, (4) Nuts.
E-9942B	2.046"	10.120"	B	Bronze	(4) E-10194		(4) Fittings, (2) Seals, (4) Lock Pins, (4) Nuts.
E-11785B	2.046"	11.00"	B	Bronze	(4) E-10194		(6) Shims, (4) Fittings, (4) Lock Pins, (4) Nuts, (6) Seals, (4) O-Rings.

KING PIN KIT IDENTIFICATION - TAPERED TYPE

King Pin Kit Part No.	King Pin Large Dia.	King Pin Small Dia.	King Pin Length	King Pin Type	Bushing Type	Bushing	Shim	Additional Contents / Notes
E-4435B	1.434"	1.186"	8.750"	D	Bronze	(2) E-4521 (2) E-4522 (2) E-4523	(6) E-4573	(2) Cotter Pins, (2) Lock Rings, (2) Plugs, (4) Gaskets, (6) Screws, (2) Washers, (2) Nuts
E-4435N	1.434"	1.186"	8.750"	D	Bronze Nylon Nylon	(2) E-4521 (2) E-4524 (2) E-4525	(6) E-4573	(2) Cotter Pins, (2) Lock Rings, (2) Plugs, (4) Gaskets, (6) Screws, (2) Retainers, (2) Washers, (2) Nuts
E-5441B	1.434"	1.186"	9.406"	D	Bronze	(2) E-5449 (4) E-4523	(6) E-4573	(2) Cotter Pins, (2) Snap Rings, (2) Plugs, (2) Gaskets, (6) Screws, (2) Nuts
E-4434N	1.607"	1.308"	9.750"	D	Bronze Nylon	(2) E-4518 (4) E-4520	(4) E-4577	(2) Cotter Pins, (2) Spacers, (2) Snap Rings, (2) Plugs, (2) Gaskets, (2) Retainers, (6) Screws, (12) Washers, (2) Nuts
E-4434B	1.607"	1.308"	9.750"	D	Bronze	(2) E-4518 (4) E-4519	(4) E-4577	(2) Cotter Pins, (2) Snap Rings, (2) Plugs, (2) Gaskets, (2) Retainers, (6) Screws, (12) Washers, (2) Nuts
E-4467B	1.625"	1.375"	7.470"	E	Bronze	(2) E-4562		(2) Needle Bearings, (4) Seals, (2) Plugs
E-10165N	1.750"	1.375"	9.00"	F	Nylon			Volvo 10,000 & 12,000
E-4599B	2.125"	1.750"	8.750"	E	Bronze	(2) E-5444		(2) Needle Bearings, (4) Seals, (2) Plugs
E-10166N	2.875"	1.500"	9.875"	F	Nylon			Volvo 14,000

KING PIN KIT TO BUSHING

King Pin Kit	Bushing Type	Bushing Number	Qty per Kit
E-4430B	Bronze	E-4513	(4)
E-4431B	Bronze	E-4514	(4)
E-4434B	Bronze	E-4519	(4)
	Bronze	E-4518	(2)
E-4434N	Bronze	E-4518	(2)
	Nylon	E-4520	(4)
E-4435B	Bronze	E-4521	(2)
	Bronze	E-4523	(2)
	Bronze	E-4522	(2)
E-4435N	Nylon	E-4525	(2)
	Nylon	E-4524	(2)
	Bronze	E-4521	(2)
E-4438B	Bronze	E-4531	(4)
E-4438N	Nylon	E-4532	(4)
E-4440B	Bronze	E-4536	(4)
E-4441B	Bronze	E-4523	(4)
E-4442B	Bronze	E-4534	(4)
E-4443B	Bronze	E-4538	(4)
E-4443N	Nylon	E-4539	(4)
E-4444B	Bronze	E-4513	(4)
E-4444N	Nylon	E-4540	(4)
E-4445B	Bronze	E-4541	(4)
E-4445N	Nylon	E-4542	(4)
E-4448B	Bronze	E-4543	(4)
E-4449B	Bronze	E-4519	(4)
E-4450B	Bronze	E-4545	(4)
E-4451B	Bronze	E-4544	(4)
E-4452B	Bronze	E-4546	(4)
E-4453B	Bronze	E-4547	(4)
E-4454B	Bronze	E-4549	(4)
E-4454N	Nylon	E-4550	(4)
E-4457B	Bronze	E-4552	(4)
E-4458B	Bronze	E-4553	(4)
E-4458C	Composite	E-5442	(4)
E-4459B	Bronze	E-4554	(4)
E-4459C	Composite	E-5445	(4)
E-4460B	Bronze	E-4555	(4)
E-4461B	Bronze	E-4543	(4)
E-4462B	Bronze	E-4544	(4)
E-4463B	Bronze	E-4544	(4)

King Pin Kit	Bushing Type	Bushing Number	Qty per Kit
E-4467B	Bronze	E-4562	(2)
E-4468B	Bronze	E-4545	(4)
E-4469B	Bronze	E-4563	(4)
E-4470B	Bronze	E-4564	(4)
E-4471B	Bronze	E-4564	(4)
E-4595B	Bronze	E-5450	(4)
E-4598B	Bronze	E-4564	(4)
E-4599B	Bronze	E-5444	(2)
E-4693B	Bronze	E-4544	(4)
E-4694C	Composite	E-5445	(4)
E-4695C	Composite	E-5445	(4)
E-4696B	Bronze	E-10192	(4)
E-4696C	Composite	E-5446	(2)
E-4697B	Bronze	E-4544	(4)
E-5441B	Bronze	E-4523	(4)
	Bronze	E-5449	(2)
E-6194B	Bronze	E-10196	(4)
E-6194C	Composite	E-10189	(4)
E-6195B	Bronze	E-10190	(4)
E-6196B	Bronze	E-4554	(4)
E-6197B	Bronze	E-4552	(4)
E-6198B	Bronze	E-4555	(4)
E-6199B	Bronze	E-4545	(4)
E-6199C	Composite	E-5445	(4)
E-6450B	Bronze	E-10186	(4)
E-6451B	Bronze	E-10186	(4)
E-6453B	Bronze	E-10185	(4)
E-6454C	Composite	E-10188	(4)
E-6455B	Bronze	E-10195	(4)
E-6455C	Composite	E-10187	(4)
E-6868B	Bronze	E-4545	(4)
E-6869C	Composite	E-5446	(4)
E-6875C	Composite	E-10191	(4)
E-9312B	Bronze	E-10184	(4)
E-9941B	Bronze	E-10193	(4)
E-9942B	Bronze	E-10194	(4)
E-9943B	Bronze	E-4546	(4)
E-9945B	Bronze	E-4564	(4)
E-11394B	Bronze	E-11791	(4)
E-11785B	Bronze	E-10194	(4)

BUSHING TO KING PIN KIT

Bushing Number	Bushing Type	King Pin Kit	Qty per Kit
E-4513	Bronze	E-4430B	(4)
	Bronze	E-4444B	(4)
E-4514	Bronze	E-4431B	(4)
E-4518	Bronze	E-4434B	(2)
	Bronze	E-4434N	(2)
E-4519	Bronze	E-4434B	(4)
	Bronze	E-4449B	(4)
E-4520	Nylon	E-4434N	(4)
E-4521	Bronze	E-4435B	(2)
	Bronze	E-4435N	(2)
E-4522	Bronze	E-4435B	(2)
E-4523	Bronze	E-4435B	(2)
	Bronze	E-4441B	(4)
	Bronze	E-5441B	(4)
	Bronze	E-5441B	(4)
E-4524	Nylon	E-4435N	(2)
E-4525	Nylon	E-4435N	(2)
E-4531	Bronze	E-4438B	(4)
E-4532	Nylon	E-4438N	(4)
E-4534	Bronze	E-4442B	(4)
E-4536	Bronze	E-4440B	(4)
E-4538	Bronze	E-4443B	(4)
E-4539	Nylon	E-4443N	(4)
E-4540	Nylon	E-4444N	(4)
E-4541	Bronze	E-4445B	(4)
E-4542	Nylon	E-4445N	(4)
E-4543	Bronze	E-4448B	(4)
	Bronze	E-4461B	(4)
E-4544	Bronze	E-4451B	(4)
	Bronze	E-4462B	(4)
	Bronze	E-4463B	(4)
	Bronze	E-4693B	(4)
	Bronze	E-4697B	(4)
E-4545	Bronze	E-4450B	(4)
	Bronze	E-4468B	(4)
	Bronze	E-6199B	(4)
	Bronze	E-6868B	(4)
E-4546	Bronze	E-4452B	(4)
	Bronze	E-9943B	(4)
E-4547	Bronze	E-4453B	(4)
E-4549	Bronze	E-4454B	(4)

Bushing Number	Bushing Type	King Pin Kit	Qty per Kit
E-4550	Nylon	E-4454N	(4)
E-4552	Bronze	E-4457B	(4)
	Bronze	E-6197B	(4)
E-4553	Bronze	E-4458B	(4)
E-4554	Bronze	E-4459B	(4)
	Bronze	E-6196B	(4)
E-4555	Bronze	E-4460B	(4)
	Bronze	E-6198B	(4)
E-4562	Bronze	E-4467B	(2)
E-4563	Bronze	E-4469B	(4)
E-4564	Bronze	E-4470B	(4)
	Bronze	E-4471B	(4)
	Bronze	E-4598B	(4)
	Bronze	E-9945B	(4)
E-5442	Composite	E-4458C	(4)
E-5444	Bronze	E-4599B	(2)
E-5445	Composite	E-4459C	(4)
	Composite	E-4694C	(4)
	Composite	E-4695C	(4)
	Composite	E-6199C	(4)
E-5446	Composite	E-4696C	(2)
	Composite	E-6869C	(4)
E-5449	Bronze	E-5441B	(2)
E-5450	Bronze	E-4595B	(4)
E-10184	Bronze	E-9312B	(4)
E-10185	Bronze	E-6453B	(4)
E-10186	Bronze	E-6450B	(4)
	Bronze	E-6451B	(4)
E-10187	Composite	E-6455C	(4)
E-10188	Composite	E-6454C	(4)
E-10189	Composite	E-6194C	(4)
E-10190	Bronze	E-6195B	(4)
E-10191	Composite	E-6875C	(4)
E-10192	Bronze	E-4696B	(4)
E-10193	Bronze	E-9941B	(4)
E-10194	Bronze	E-11785B	(4)
	Bronze	E-9942B	(4)
E-10195	Bronze	E-6455B	(4)
E-10196	Bronze	E-6194B	(4)
E-11791	Bronze	E-11394B	(4)

SHIMS BY I.D.

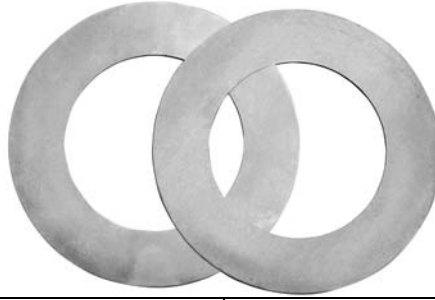

Part Number	Inside Diameter	Outside Diameter	Thickness
E-9220	.875"	1.562"	.005"
E-9221	.953"	1.750"	.005"
E-4572	1.156"	1.750"	.010"
E-4573	1.200"	1.938"	.005"
E-4576	1.281"	1.875"	.010"
E-4575	1.281"	2.000"	.005"
E-10170	1.281"	2.000"	.015"
E-4577	1.391"	2.234"	.005"
E-4579	1.500"	2.375"	.005"
E-10172	1.516"	2.375"	.015"
E-10167	1.625"	2.687"	.010"
E-10171	1.625"	2.687"	.015"
E-4580	1.625"	2.688"	.005"
E-10176	1.660"	2.625"	.005"
E-10177	1.660"	2.625"	.010"
E-4581	1.805"	2.500"	.005"
E-10169	1.805"	2.500"	.010"
E-10168	1.805"	2.500"	.015"
E-4582	1.875"	2.812"	.005"
E-10173	1.875"	2.812"	.015"
E-10174	2.010"	3.250"	.015"
E-4583	2.010"	3.260"	.005"
E-10175	2.010"	3.260"	.030"

If you detect any

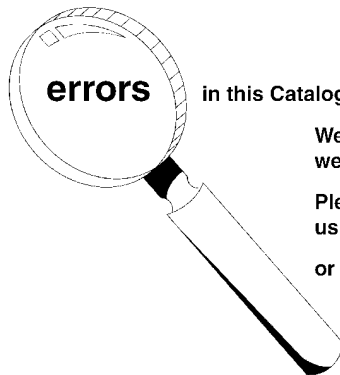

in this Catalog, please let us know.

We want the information to be as accurate as possible;
we appreciate your help in making it so.

Please e-mail any comments/suggestions/corrections to
us at: catalogfeedback@arvinmeritor.com

or mail to: Euclid Industries, LLC
 Attn: Catalog Dept.
 7975 Dixie Highway
 Florence, KY 41042-2754

TIE ROD AND DRAG LINK ENDS

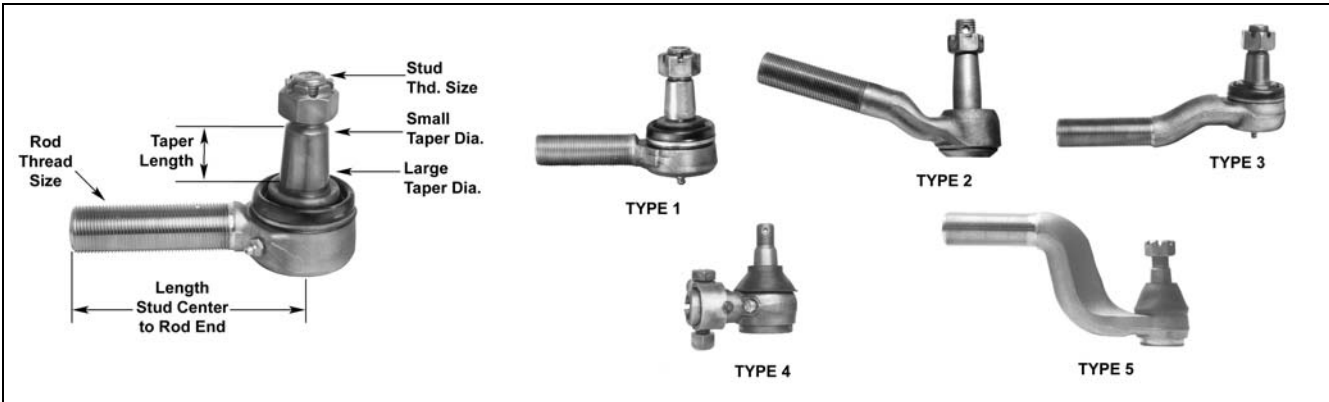

Part Number	Stud Center to Rod End	Rod Thread Size	Taper Length	Large Taper Dia.	Small Taper Dia.	Stud Thread Size	Style	Type	Industry Number	Comments
E-10114	2.75"	.875"-14	1.375"	1.250"	1.077"	.875"-14		4		
E-6774	3.12"	.75"-16 RH	.75"	.625"	.543"	.50"-20	Curbside	1	ES2847R	
E-5392	3.12"	.937"-20 RH	1.112"	1.035"	.896"	.75"-16	Curbside	4	ES2030R	
E-9967	3.12"	1.00"-16 RH	1.08"	1.102"	.967"	.875"-14	Curbside	4	ES3304R	
E-6665	3.38"	.875"-18 LH	.75"	.773"	.675"	.625"-18	Roadside	1	ES2010L	
E-4635	3.50"	.75"-16 RH	.75"	.701"	.612"	.563"-18	Curbside	1	ES150R	
E-4634		.75"-16 LH					Roadside		ES150L	
E-4601	3.875"	1.00"-16 RH	.87"	.773"	.664"	.625"-18	Curbside	1	ES235NR	
E-4600		1.00"-16 LH					Roadside		ES235NL	
E-4637	3.875"	1.00"-16 RH	.90"	.874"	.762"	.625"-18	Curbside	1	ES176R	
E-4636		1.00"-16 LH					Roadside		ES176L	
E-4603	3.875"	1.00"-16 RH	.95"	.899"	.78"	.75"-16	Curbside	1	ES304R	
E-4602		1.00"-16 LH					Roadside		ES304L	
E-6720	4.125"	1.00"-18 RH	.75"	.773"	.675"	.625"-18	Curbside	1	ES2011R	
E-4605	4.438"	1.00"-16 RH	.93"	.899"	.783"	.75"-16	Curbside	1	ES373R	
E-4604		1.00"-16 LH					Roadside		ES373L	
E-10163	4.72"	M30 x 1.50	1.50"	1.126"	.942"	M20 x 1.50	Curbside	1	V1698846	
E-10164		M30 x 1.50					Roadside		V1698847	
E-6722	4.80"	.875"-18 RH	.75"	.773"	.675"	.625"-18	Curbside	1	ES2234R	
E-4609	4.875"	1.125"-12 RH	1.07"	1.031"	.896"	.75"-16	Curbside	1	ES2069R	Anti-tilt seal
E-4608		1.125"-12 LH					Roadside		ES2070L	
E-4607	4.875"	1.125"-12 RH	1.07"	1.031"	.896"	.75"-16	Curbside	1	ES405R	
E-4606		1.125"-12 LH					Roadside		ES405L	
E-4611	4.875"	1.125"-12 RH	1.08"	1.102"	.967"	.875"-14	Curbside	1	ES187R	
E-4610		1.125"-12 LH					Roadside		ES187L	
E-4640	4.875"	1.125"-16 RH	1.08"	1.102"	.967"	.875"-14	Curbside	1	ES2118L	
E-4613	4.938"	1.00"-16 RH	.93"	.899"	.783"	.75"-16	Curbside	1	ES2062R	
E-4612		1.00"-16 LH					Roadside		ES2061L	
E-6678	4.98"	.875"-18 RH	1.00"	.733"	.664"	.625"-18	Curbside	2	ES2147R	
E-10113	5.02"	1.00"-16 RH	.87"	1.024"	.915"	.75"-16	Curbside	1	ES3269R	
E-10112		1.00"-16 LH					Roadside		ES3268L	
E-6789	5.39"	1.00"-18 RH	.75"	.703"	.615"	M14 x 1.50	Curbside	1	ES2914R	
E-10111	5.44"	1.125"-12 RH	.87"	1.024"	.915"	.75"-16	Curbside	1	ES3271R	
E-10110		1.125"-12 LH					Roadside		ES3270L	
E-4615	5.44"	1.125"-12 RH	1.08"	1.102"	.967"	.875"-14	Curbside	1	ES423R	
E-4614		1.125"-12 LH					Roadside		ES423L	
E-5470	5.44"	1.125"-12 RH	1.08"	1.102"	.967"	.875"-14	Curbside	2	ES2614R	
E-5469		1.125"-14 LH					Roadside		ES2613L	
E-10109	5.44"	1.125"-12 RH	1.14"	1.181"	1.038"	.875"-14	Curbside	1	ES3275R	
E-10108		1.125"-12 LH					Roadside		ES3274L	
E-6849	5.50"	1.25"-12 RH	1.08"	1.102"	.967"	.875"-14	Curbside	1	ES2203R	

TIE ROD AND DRAG LINK ENDS

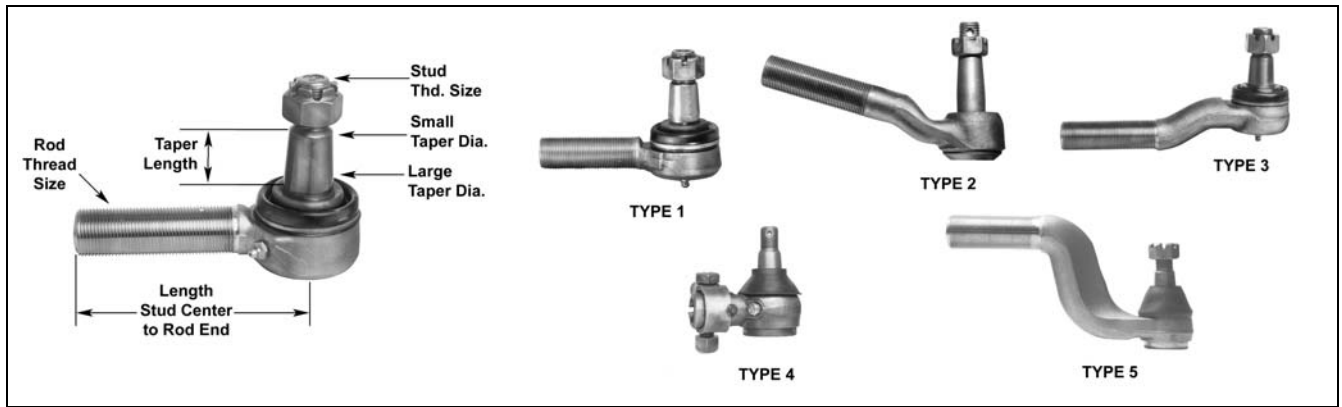

Part Number	Stud Center to Rod End	Rod Thread Size	Taper Length	Large Taper Dia.	Small Taper Dia.	Stud Thread Size	Style	Type	Industry Number	Comments
E-5402	5.75"	1.25"-12 RH	1.06"	1.25"	1.117"	.875"-14	Curbside	1	ES2225R	
E-5391		1.25"-12 LH					Roadside		ES2224L	
E-4618	5.75"	1.25"-12 RH	1.36"	1.25"	1.08"	.875"-14	Curbside	1	ES346L	Anti-tilt seal. Side zerk
E-4619		1.25"-12 LH					Roadside		ES346R	
E-9878	5.75"	1.25"-12 RH	1.36"	1.25"	1.08"	.875"-14	Curbside	1		Side zerk
E-9877		1.25"-12 LH					Roadside			
E-4617	5.75"	1.25"-12 RH	1.36"	1.25"	1.08"	.875"-14	Curbside	1	ES431R	Zerk on bottom
E-4616		1.25"-12 LH					Roadside		ES431L	
E-9881	5.75"	1.25"-12 RH	-	1.25"	1.25"	-	Curbside	1	ES3252R	
E-4642	5.75"	1.25"-16 RH	1.25"	1.25"	1.08"	.875"-14	Curbside	1	ES2208R	
E-6858	5.75"	1.25"-18 RH	1.25"	1.25"	1.08"	.875"-14	Roadside		ES3032R	
E-4621	5.84"	1.00"-16 RH	.93"	.899"	.783"	.75"-16	Curbside	1	ES330R	
E-4620		1.00"-16 LH					Roadside		ES330L	
E-9963 ¹	6.00"	1.125"-12 RH	1.08"	1.102"	.967"	.875"-14	Curbside	1	ES3176R	
E-9962 ¹		1.125"-12 LH					Roadside		ES3177L	
E-10137 ²	6.00"	1.125"-12 RH	1.08"	1.102"	.967"	.875"-14	Curbside	1	ES3476	
E-10138 ²		1.125"-12 LH					Roadside		ES3477	
E-4623	6.07"	1.00"-16 RH	.93"	.899"	.783"	.75"-16	Curbside	1	ES2036R	
E-4622		1.00"-16 LH					Roadside		ES2035L	
E-6404	6.34"	.875"-18 LH	.620"	.793"	.715"	.625"-18	Roadside	1	ES2027L	
E-4625	6.50"	1.125"-16 RH	.75"	.995"	.893"	.75"-16	Curbside	1	ES332R	
E-4624		1.125"-16 LH					Roadside		ES332L	
E-6694	6.84"	1.00"-16 LH	.75"	.72"	.613"	M14 x 1.50	Curbside	1	ES2925L	
E-9966	7.188"	1.00"-16 RH	.93"	.899"	.783"	.75"-16	Curbside	1	ES3283R	
E-9965		1.00"-16 LH					Roadside		ES3284L	
E-9879	7.37"	1.25"-12 RH	1.25"	1.25"	1.08"	.875"-14	Curbside	1	ES3034R	Side zerk
E-9880		1.25"-12 LH					Roadside		ES3033L	
E-4628	7.37"	1.25"-12 LH	1.36"	1.25"	1.08"	.875"-14	Roadside	1	ES2090L	Zerk on bottom
E-4629		1.25"-12 RH					Curbside		ES2091R	
E-11788	7.75"	1.25"-12 RH	1.08"	1.102"	.967"	.875"-14	Curbside	1	ES3442R	
E-11789		1.25"-12 LH					Roadside		ES3443L	
E-8758	8.125"	1.25"-12 RH	1.20"	1.102"	.967"	.875"-14	Curbside	3	ES3297R	
E-8757		1.25"-12 LH					Roadside		ES3298L	
E-6403	8.34"	.875"-18 RH	.620"	.793"	.715"	.625"-18	Curbside	1	ES2026R	
E-4631	9.188"	1.125"-12 RH	1.08"	1.102"	.967"	.875"-14	Curbside	1	ES411R	
E-4630		1.125"-12 LH					Roadside		ES411L	
E-9952	9.438"	1.125"-12 RH	1.08"	1.102"	.967"	.875"-14	Curbside	1	ES3220R	
E-9951		1.125"-12 LH					Roadside		ES3219L	
E-6848	10.50"	1.625"-12 RH	1.08"	1.102"	.967"	.875"-14	Curbside	5	ES2201R	
E-6847		1.625"-12 LH					Roadside		ES2200L	

1 Stud center to beginning of rod threads 2.53".

2 Stud center to beginning of rod threads 1.68".

TIE ROD AND DRAG LINK ENDS

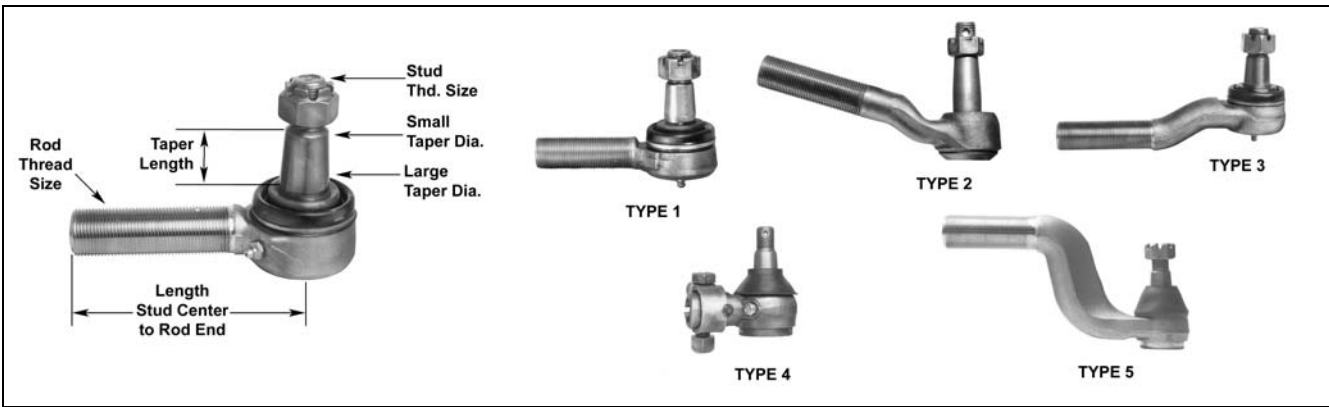

Part Number	Stud Center to Rod End	Rod Thread Size	Taper Length	Large Taper Dia.	Small Taper Dia.	Stud Thread Size	Style	Type	Industry Number	Comments
E-6855	10.81"	1.375"-12 RH	.93"	.899"	.783"	.75"-16	Curbside	5	ES3027R	
E-6854		1.375"-12 LH					Roadside		ES3026L	
E-6136	10.84"	1.875"-12 RH	1.08"	1.102"	.967"	.875"-14	Curbside	5	ES3087R	
E-6135		1.875"-12 LH					Roadside		ES3086L	
E-9948	12.375"	1.25"-12 RH	1.25"	1.25"	1.08"	.875"-14	Curbside	4	ES3214R	
E-6856	12.688"	1.875"-12 RH	1.25"	1.25"	1.08"	.875"-14	Curbside	3	ES3030R	
E-6857		1.875"-12 LH					Roadside		ES3031L	
E-6864	13.25"	1.438"-12 RH	.93"	.899"	.783"	.75"-16	Curbside	1	ES3040R	
E-6863		1.438"-12 LH					Roadside		ES3039L	

S.O.S.

Special Order Service

Can't find it?

Trouble sourcing products?

Need assistance?

*Let Euclid's Special Order Service (**S.O.S.**) help you find your parts.*



Euclid's position as the market leader provides you access to a comprehensive array of truck parts products from the industry's leading manufacturers. Through Euclid, these entire product lines are available to you just by placing a phone call to Euclid's S.O.S.

Department at 866-238-2543 (option 2) in the U.S. or 800-387-3889 in Canada.



an **ArvinMeritor™** brand

DRAG LINKS LISTED BY LENGTH

	Part Number	Length Stud Ctr to Stud Ctr	Large Taper Dia.	Small Taper Dia.	Taper Length	Stud Thread Size	Industry Number
	E-6818	14.21"	1.25"	1.08"	1.36"	.875"-14	DS1179
 Uses Replaceable Drag Link End E-5397	E-5386 ³	16.27"	1.25"	1.08"	1.36"	.875"-14	DS1020
	E-5310	16.64"	.905"	.783"	.99"	.75"-16	DS800
	E-5390	16.84"	.874"	.762"	.89"	.625"-18	DS1034
	E-6815	16.89"	1.03"	.896"	1.07"	.75"-16	DS1044
	E-6817	16.89"	1.035"	.904"	1.12"	.75"-16	DS1067
	E-6816	17.00"	.902"	.785"	.98"	.75"-16	DS1064
 Uses Replaceable Drag Link End E-6849	E-6804 ³	17.13"	1.102"	.967"	1.08"	.875"-14	DS1022
 Uses Replaceable Drag Link End E-5397	E-6808 ³	17.29"	1.085"	.906"	1.43"	.875"-14	DS1028



Note: All drag links are one piece - non-replaceable ends except as noted.
³ Two Piece - one replaceable end.

DRAG LINKS LISTED BY LENGTH

	Part Number	Length Stud Ctr to Stud Ctr	Large Taper Dia.	Small Taper Dia.	Taper Length	Stud Thread Size	Industry Number
 <p style="text-align: center;">Uses Replaceable Drag Link End E-6849</p>	E-6878 ³	17.37"	1.102"	.967"	1.08"	.875"-14	DS1031
	E-11463	17.47"	.874"	.762"	.896"	.625"-18	DS1215
	E-9925	17.53"	1.25" 1.102"	1.080" .967"	1.36" 1.08"	.875"-14 .875"-14	DS1265
	E-9911	17.68"	1.102"	.967"	1.08"	.875"-14	DS1214
	E-5326	17.70"	1.03"	.896"	1.07"	.75"-16	DS910
	E-5374	17.90"	1.03"	.896"	1.07"	.75"-16	DS988
	E-9933	17.91"	1.102"	.967"	1.08"	.875"-14	DS1270
	E-5372	17.93"	1.102"	.967"	1.08"	.875"-14	DS986
	E-5373	17.96"	1.103"	.973"	1.04"	.875"-14	DS987

Note: All drag links are one piece - non-replaceable ends except as noted.
³ Two Piece - one replaceable end.

DRAG LINKS LISTED BY LENGTH

	Part Number	Length Stud Ctr to Stud Ctr	Large Taper Dia.	Small Taper Dia.	Taper Length	Stud Thread Size	Industry Number
	E-5325	18.03"	1.256" 1.107"	1.080" .967"	1.41" 1.12"	.875"-14 .875"-14	DS908
	E-5366	18.14"	1.103"	.973"	1.04"	.875"-14	DS979
 Uses Replaceable Drag Link Ends E-5391 (LH) and E-5402 (RH)	E-6806 ⁴	18.38"	1.25"	1.117"	1.06"	.875"-14	DS1024
	E-6833	18.50"	1.102"	.967"	1.08"	.875"-14	DS1199
	E-6834	18.58"	1.102"	.967"	1.08"	.875"-14	DS1200
Photo not available at time of printing	E-11790	19.06"	1.25" 1.102"	1.08" .967"	1.36" 1.08"	.875"-14 .875"-14	DS1442
	E-6836	19.23"	1.102" 1.25"	.967" 1.08"	1.08" 1.36"	.875"-14 .875"-14	DS1204
	E-5339	19.23"	1.25" 1.102"	1.08" .967"	1.36" 1.08"	.875"-14 .875"-14	DS949
	E-5338	19.25"	.899"	.783"	.928"	.75"-16	DS948







Note: All drag links are one piece - non-replaceable ends except as noted.
⁴ Three Piece - two replaceable ends.

DRAG LINKS LISTED BY LENGTH

	Part Number	Length Stud Ctr to Stud Ctr	Large Taper Dia.	Small Taper Dia.	Taper Length	Stud Thread Size	Industry Number
	E-9936	19.43"	1.102"	.967"	1.08"	.875"-14	DS1369
	E-9934	19.47"	1.102"	.967"	1.08"	.875"-14	DS1271
	E-6827	20.66"	.904"	.78"	.92"	.75"-16	DS1191
	E-9937	21.23"	1.03"	.915"	1.08"	.75"-16	DS1366
	E-9929	22.61"	1.102"	.967"	1.08"	.875"-14	DS1269
 Uses Replaceable Drag Link End E-4629	E-8732 ³	28.25"	1.25"	1.08"	1.36"	.875"-14	DS1454
	E-6825	28.28"	1.25"	1.08"	1.36"	.875"-14	DS1186
	E-9897	28.87"	1.102"	.967"	1.08"	.875"-14	DS1218
 Uses Replaceable Drag Link End E-4629	E-5378 ³	29.56"	1.25"	1.08"	1.36"	.875"-14	DS992

Note: All drag links are one piece - non-replaceable ends except as noted.
³ Two Piece - one replaceable end.

DRAG LINKS LISTED BY LENGTH

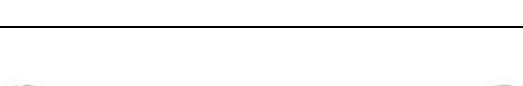
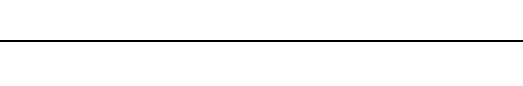
	Part Number	Length Stud Ctr to Stud Ctr	Large Taper Dia.	Small Taper Dia.	Taper Length	Stud Thread Size	Industry Number
Uses Replaceable Drag Link End E-4629	E-5379 ³	29.56"	1.25"	1.08"	1.36"	.875"-14	DS993
Uses Replaceable Drag Link End E-4629	E-5380 ³	30.56"	1.25"	1.08"	1.36"	.875"-14	DS994
	E-6819	31.69"	1.25"	1.08"	1.36"	.875"-14	DS1180
	E-9926	32.53"	1.102"	.967"	1.08"	.875"-14	DS1266
	E-9927	32.53"	1.102"	.967"	1.08"	.875"-14	DS1268
	E-6839	32.62"	1.255" 1.105"	1.090" .970"	1.43" 1.12"	.875"-14 .875"-14	DS1207
	E-6835	36.15"	1.105" 1.255"	.970" 1.080"	1.12" 1.42"	.875"-14 .875"-14	DS1203
	E-5342	36.31"	1.256" 1.107"	1.080" .967"	1.41" 1.12"	.875"-14 .875"-14	DS943
	E-9931	37.13"	1.25" 1.102"	1.080" .967"	1.36" 1.08"	.875"-14 .875"-14	DS1234

Note: All drag links are one piece - non-replaceable ends except as noted.
³ Two Piece - one replaceable end.

DRAG LINK PART NUMBER TO LENGTH

Part Number	Length
E-5310	16.64"
E-5325	18.03"
E-5326	17.70"
E-5338	19.25"
E-5339	19.23"
E-5342	36.31"
E-5366	18.14"
E-5372	17.93"
E-5373	17.96"
E-5374	17.90"
E-5378	29.56"
E-5379	29.56"
E-5380	30.56"
E-5386	16.27"
E-5390	16.84"

Part Number	Length
E-6804	17.13"
E-6806	18.38"
E-6808	17.29"
E-6815	16.89"
E-6816	17.00"
E-6817	16.89"
E-6818	14.21"
E-6819	31.69"
E-6825	28.28"
E-6827	20.66"
E-6833	18.50"
E-6834	18.58"
E-6835	36.15"
E-6836	19.23"
E-6839	32.62"

Part Number	Length
E-6878	17.37"
E-8732	28.25"
E-9897	28.87"
E-9911	17.68"
E-9925	17.53"
E-9926	32.53"
E-9927	32.53"
E-9929	22.61"
E-9931	37.13"
E-9933	17.91"
E-9934	19.47"
E-9936	19.43"
E-9937	21.23"
E-11463	17.47"
E-11790	19.06"

CROSTUBES

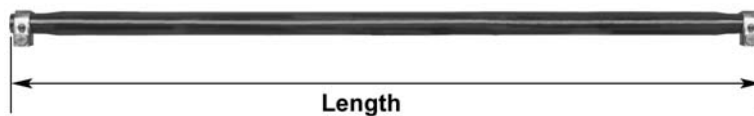

Part Number	Length C/L- C/L of Ends	Length w/o Ends	Crosstube Diameter	Thread Size	Adjustment Range	Tie Rod Ends	OEM Reference	Industry Number
Crosstube Assemblies with Tie Rod Ends								
E-9959	65.80"	59.50"	1.50"	1.125"-12	63.86"-66.14"	E-4614 (LH) E-4615 (RH)	E4HZ-3208B	DS1367A
E-9964	66.03"	60.50"	1.75"	1.125"-12	65.76"-68.02"	E-9962 (LH) E-9963 (RH)	F5HZ-3290A	DS1368A
E-9961	66.54"	58.00"	1.50"	1.25"-12	65.19"-68.37"	E-11788 (RH) E-11789 (LH)	F1HZ-3280C	DS1261
Crosstubes without Tie Rod Ends								
E-9958		55.49"	1.75"	1.125"-12			F0HZ-3281A	DS1380S
E-9960		57.63"	1.50"	1.00"-16			F0HZ-3281B	DS1362S
E-9957		59.34"	1.50"	1.125"-12			D0HZ-3181A	DS1379S

INDEX

Application Guide	Page
Dana/Spicer	11-19
Eaton	11-22
Ford	11-24
Freightliner	11-59
GMC/Chevrolet	11-63
Kenworth	11-104
Mack	11-114
Meritor	11-128
Navistar	11-140
Peterbilt	11-173
Volvo	11-178
Western Star	11-184
Westport	11-186
White	11-188

HOW TO USE APPLICATION DATA CHARTS

1. Refer to correct Vehicle Manufacturer section. See Index for page number where each section begins.

2. Find correct Model Number in each section's own index. Model listing will begin on the page shown.

3. Representative model illustrations aid in determining model.

4. Model listings are by Axle Rating/Code and Model Year.

Model	Page No.
252, 282, 289, 300, 348	11-31
310, 320, 330, 357, 362	11-32

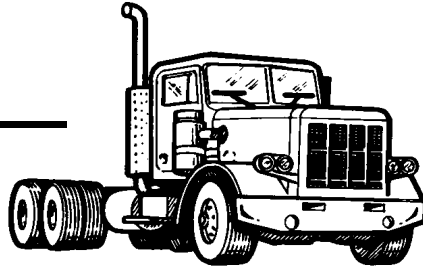

252, 282, 289, 300, 348, 352, 352H, 353, 359

King Pin Kits

Axle Rating Lbs.	Axle Code/ Year	Part Number/ Bushing Type	King Pin Size	Type	OEM Reference	Notes
12000	(FE900)	E-4434B Bronze	9.750"	D	KIT 144	Tapered pin.
		E-4434N Nylon			KIT 123	

Some Euclid part numbers have the same base number. Suffix "B" denotes Metal Bushing. Suffix "N" denotes Nylon Bushing. Suffix "C" denotes Composite Metal/Plastic Bushings.

Refer to King Pin identification charts starting on page 11-1.

Descriptive section headings eliminate confusing footnotes.

Tie Rod Ends

Axle Rating Lbs.	Axle Code/ Year	Part Number/ Location	Stud Center to Rod End	OEM Reference	Notes
12000	(FE900)	E-4611 Curbside	4.875"	A3144R226	
		E-4610 Roadside		A3144Q225	

"Curbside", "Roadside" designations for positive identification. Prevents confusion of "(RH)", "(LH)".

Drag Links

Axle Rating Lbs.	Axle Code/ Year	Part Number	Stud Center to Stud Center	OEM Reference	Notes
All	All	E-6818	14.21"	10-02163	L24VU7050B12, DS1179, Rpl/10-2131.
		E-6819	31.69"	10-02260	L24VU7051B12, DS1180, Rpl/10-2132.

INDEX

Model	Page No.
I100SA thru I146SA	11-20
I50 thru I132	11-20

Model	Page No.
I60S thru I200S	11-20

FRONT NON-DRIVE STEERING AXLE

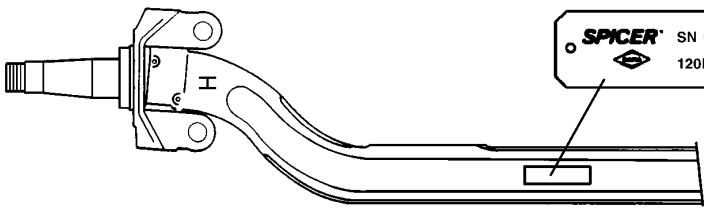

EXAMPLE OF TAG USED IN I-BEAM FRONT AXLE

SPICER SN 03189A MODEL I-20S
 120BN100-8 xxxxxxxxxx

MODEL DESIGNATION:

I - 120 S

**FRONT NON DRIVE
STEERING AXLE**

**NOMINAL LOAD
CARRYING CAPACITY CODE (below)**

50 = 5,000 lbs.	100 = 10,000 lbs.
60 = 6,000 lbs.	108 = 10,800 lbs.
75 = 7,500 lbs.	120 = 12,000 lbs.
80 = 8,000 lbs.	132 = 13,200 lbs.
90 = 9,000 lbs.	140 = 14,000 lbs.

SPICER

DANA/SPICER

I100SA thru I146SA

Tie Rod Ends

Axle Rating Lbs.	Axle Code/Year	Part Number/ Location	Stud Center to Rod End	OEM Reference	Notes
14000, 14600	I140SA, I146SA	E-4615 Curbside	5.44"	1668408C91	Straight "I" beam.
		E-4614 Roadside		1668407C91	
		E-4631 Curbside	9.188"	1668410C91	
		E-4630 Roadside		1668409C91	

I50 thru I132

King Pin Kits

Axle Rating Lbs.	Axle Code/Year	Part Number/ Bushing Type	King Pin Size	Type	OEM Reference	Notes
5000, 6000, 7500	I50, I60, I75	E-4460B Bronze	1.359" x 7.968"	A	1648204C91	
8000	I80	E-6198B Bronze	1.359" x 7.970"	B	1660271C91	
9000	I90	E-4463B Bronze	1.609" x 9.160"	A	493095C92	
		E-4697B Bronze		B	586806C91	
10800, 12000, 13200	I108, I120, I132	E-4462B Bronze	1.609" x 9.660"	A	493094C95	
		E-4693B Bronze		B	588808C91	
		E-6875C Composite			1658394C91	

Tie Rod Ends

Axle Rating Lbs.	Axle Code/Year	Part Number/ Location	Stud Center to Rod End	OEM Reference	Notes
5000, 6000, 7500, 8000	I50, I60, I75, I80	E-4605 Curbside	4.438"	1660273C91	
		E-4604 Roadside		1660272C91	
9000, 10800, 12000, 13200	I90, I108, I120, I132	E-5470 Curbside	5.44"	506662C92	Dropped I beam.
		E-5469 Roadside		506661C92	
		E-4631 Curbside	9.188"	1649638C91	Straight I beam.
		E-4630 Roadside		1649637C91	

I60S thru I200S

King Pin Kits

Axle Rating Lbs.	Axle Code/Year	Part Number/ Bushing Type	King Pin Size	Type	OEM Reference	Notes
6000, 8000	I60S, I80S, 02ADA, 02ADB	E-4460B Bronze	1.359" x 7.968"	A	473695C92	
		E-6198B Bronze	1.359" x 7.970"	B	1660271C91	
10000, 12000	I100S, I120S, 02ADC, 02ADD, 02ADG	E-9941B Bronze	1.921" x 9.87"	B	1668411C91	
14000	I140S, 02ADE	E-9942B Bronze	2.046" x 10.120"	B	1668412C91	
16000, 18000, 20000	I160S, I180S, I200S	E-11785B Bronze	2.046" x 11.00"	B	220KK100	



an **ArvinMeritor**™ brand

Axle Rating Lbs.	Axle Code/Year	Part Number/Location	Stud Center to Rod End	OEM Reference	Notes	
10000, 12000	I100S, I120S, 02ADC, 02ADD, 02ADG	E-4615 Curbside	5.44"	507838C91		
		E-4614 Roadside		507837C91		
		E-4631 Curbside	9.188"	1649638C91		
		E-4630 Roadside		1649637C91		
14000	I140S, 02ADE	E-4615 Curbside	5.44"	1668408C91	Straight I beam.	
		E-4614 Roadside		1668407C91		
		E-4631 Curbside	9.188"	1668410C91		
		E-4630 Roadside		1668409C91		
16000, 18000, 20000	I160S, I180S, I200S	E-4617 Curbside	5.75"	220TR116		
		E-4616 Roadside		220TR115		
		E-6856 Curbside	12.688"	220TR119		Dropped I beam.
		E-6857 Roadside		220TR118		

FLEET VEHICLE MAINTENANCE COMPONENTS

The Euclid Brand offers "All-Makes" Aftermarket Maintenance Components for these Vehicle Systems:

BRAKE PRODUCTS

- Euclid New Lined Brake Shoes
- Euclid Relined Brake Shoes
- Euclid Friction Materials
- Camshafts
- Air Drum Brake Components & Kits
- Air Disc Pads & Components
- Hydraulic Disc Pads
- Hydraulic Drum & Disc Brake Components
- Automatic & Manual Slack Adjusters
- Brake & Camshaft Repair Kits

WHEEL END PRODUCTS

- Cast Brake Drums
- X-30 Steelite Brake Drums
- Hubs & Spoke Wheels
- Rotors - Hydraulic Disc
- Wheel Attaching Components
- Seals & Bearings

DRIVELINE PRODUCTS

- Universal Joints - US only
- Center Bearings - US only
- Miscellaneous Hardware - US only

AIR SYSTEM PRODUCTS

- Air Dryers & Cartridges
- Air Valves - New & Reman
- Reman Air Compressors
- Air Brake Hose & Fittings

TRAILER PRODUCTS

- Axle Tubes
- "Dressed" Axles

FRONT AXLE PRODUCTS

- King Pin Kits
- Tie Rod & Drag Link Ends
- Drag Links

SUSPENSION PRODUCTS

- Air Springs
- Equalizers, Hangers, Beams
- Bushings & Hardware
- Speciality Polyurethane Components
- Torque Rods
- U-Bolts
- Gabriel®** Shock Absorbers

AIR CONDITIONING & HEATING PRODUCTS

- Compressors
- Clutches
- Blower Motors
- Receiver Driers
- Valves, Switches
- Condensor, Evaporator, Heater Cores
- Tools
- Chemicals, Lubricants
- Refrigerants

ELECTRICAL & WATER PUMPS

- Alternators
- Starters
- Electrical Parts & Accessories
- Water Pumps
- Fan Clutches Rebuilt Kits

OTHER PRODUCTS

- Ankra Cargo Restraint Systems

INDEX

Model	Page No.	Model	Page No.
Conventional Steering Arm Axles	11-23	Integral Steering Arm Axle	11-23

NON-DRIVE FRONT STEERING AXLE

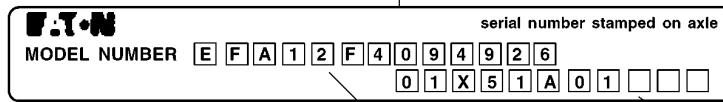
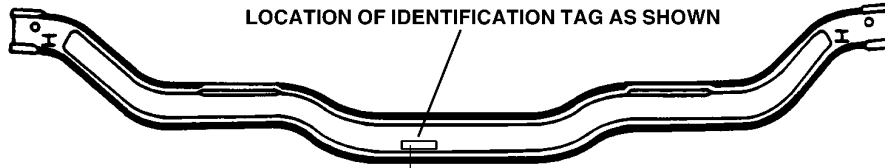

EFA 12 F 4 XXXXX

EATON FRONT AXLE

NOMINAL LOAD CARRYING CAPACITY
 12 = 12,000 lbs.
 18 = 18,000 lbs.
 22 = 20,000 lbs.
 24 = 24,000 lbs.

BEAM TYPE
 F = FORGED I-BEAM
 T = TUBULAR BEAM

DESIGN LEVEL

AXLE ASSEMBLY IDENTIFICATION NUMBER

PART NO. (if shows on plate) is the identification number used by vehicle manufacturer.

Conventional Steering Arm Axles

King Pin Kits

Axle Rating Lbs.	Axle Code/Year	Part Number/ Bushings Type	King Pin Size	Type	OEM Reference	Notes
12000, 13000	EFA-12F3, EFA-13F3	E-6869C Composite	1.625" x 9.195"	A	806356	Tapered pin.
	EFA-12F4, EFA-13F5	E-4696B Bronze			806355	
		E-4696C Composite				
18000, 20000, 22000, 24000	EFA-18F3, EFA-20F4, EFA-22T2, EFA-22T5, EFA-24T2, EFA-24T5	E-6194C Composite	1.873" x 9.965"	A	1008500	

Tie Rod Ends

Axle Rating Lbs.	Axle Code/Year	Part Number/ Location	Stud Center to Rod End	OEM Reference	Notes
12000, 13000	EFA-12F3, EFA-13F3, EFA-12F4, EFA-13F5	E-4615 Curbside	5.44"	1006148	
		E-4614 Roadside		1006149	
	E-8758 Curbside	8.125"	1009010		
	E-8757 Roadside		1009009		
18000, 20000, 22000, 24000	EFA-18F3, EFA-20F4, EFA-22T2, EFA-22T5, EFA-24T2, EFA-24T5	E-4629 Curbside	7.37"	820695	
		E-4628 Roadside		820694	

Integral Steering Arm Axle

King Pin Kits

Axle Rating Lbs.	Axle Code/Year	Part Number/ Bushings Type	King Pin Size	Type	OEM Reference	Notes
10000, 12000, 13200	E1000I, E1200I, E1320I	E-11394B Bronze	1.794" x 9.02"	B	823078	

Tie Rod Ends

Axle Rating Lbs.	Axle Code/Year	Part Number/ Location	Stud Center to Rod End	OEM Reference	Notes
10000, 12000, 13200	E1000I, E1200I, E1320I	E-10137 Curbside	6.00"	817019	
		E-10138 Roadside		817018	
14600	E-1460I	E-4629 Curbside	7.37"	820695	
		E-4628 Roadside		820694	

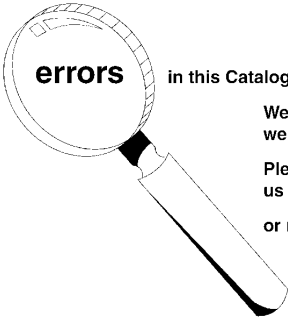

If you detect any **errors** in this Catalog, please let us know.

We want the information to be as accurate as possible; we appreciate your help in making it so.

Please e-mail any comments/suggestions/corrections to us at: catalogfeedback@arvinmeritor.com

or mail to: **Euclid Industries, LLC**
Attn: Catalog Dept.
7975 Dixie Highway
Florence, KY 41042-2754

INDEX

Model	Page No.	Model	Page No.
Aeromax (New Design) A and AT 95	11-25	HT950, H1000	11-44
B500, F500	11-25	L800, L8000 (Includes LN, LNT, LS, LT, LTL and LTS)	11-45
B600, B6000	11-25	L900, L9000	11-49
B700, B750, B7000	11-28	(Includes L, LL, LN, LNT, LS, LT, LTL and LTS)	
C500, C550, C600, CT600, C700, CT700, C7000, C750, CT750, C800, C8000, CT800, CT8000, C850, CT850, C900, CT900, C9000, CT9000, C950, CT950, C1000, C1100	11-31	LLA900, LLS900, LTLA900, LTLS900	11-53
CF600, CF700	11-33	LN500	11-53
CF800, CFT800	11-34	LN600	11-53
CL900, CLT900, CL9000, CLT9000	11-34	LN700, LN750	11-54
F1000, F1100	11-35	LNT880, LT880	11-55
F600, F6000, FT600, FT6000, F700, F7000, FT700 F750	11-36	Louisville (New Design) L and LT 85/95	11-55
F800, FT800, F880, F8000	11-39	M400 Motor Home Chassis	11-56
F850, F950	11-41	N500, N600, N6000, N8000, N850, NT850, N950, NT950, N1000, N1100	11-56
F900, F9000, FT900, FT9000	11-42	P400, P500, P600	11-56
		T800, T850, T950	11-57
		W900, WT900, W9000, WT9000, W1000, WT10000	11-57



B500-700

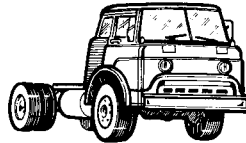

C & CT500-8000

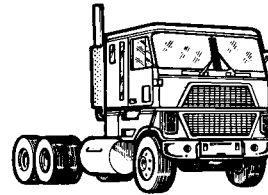

CL & CLT9000



F-600-850
(From 1980 to current)



F-600-850
(Prior to 1980)

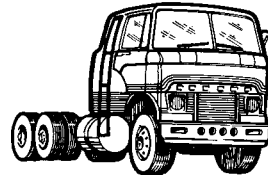

H & HT1000

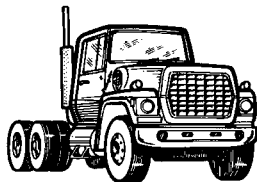

L, LN, LNT, LT500-9000

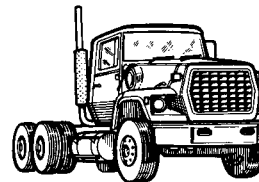

LTS900-9000



N & NT500-1000

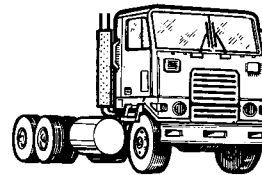

W & WT1000

Aeromax (New Design) A and AT 95

Tie Rod Ends

Axle Rating Lbs.	Axle Code/Year	Part Number/ Location	Stud Center to Rod End	OEM Reference	Notes
12000, 13000	1996-98	E-11788 Curbside	7.75"	F6HZ-3A130AA	
		E-11789 Roadside		F6HZ-3A131AA	

Drag Links

Axle Rating Lbs.	Axle Code/Year	Part Number	Stud Center to Stud Center	OEM Reference	Notes
13000	1996-97	E-11790	19.06"	F6HZ-3304FB	

B500, F500

King Pin Kits

Axle Rating Lbs.	Axle Code/Year	Part Number/ Bushing Type	King Pin Size	Type	OEM Reference	Notes
5000	1961-77	E-4440B Bronze	1.231" x 7.860"	C	C3TZ-3111A	

Tie Rod Ends

Axle Rating Lbs.	Axle Code/Year	Part Number/ Location	Stud Center to Rod End	OEM Reference	Notes
5000	1953-66	E-4635 Curbside	3.50"	C1TZ-3A130A	w/Manual steering.
		E-4634 Roadside		C1TZ-3A131A	
	1967-77	E-4605 Curbside	4.438"	C7TZ-3A130D	
		E-4604 Roadside		C7TZ-3A131D	

Drag Links

Axle Rating Lbs.	Axle Code/Year	Part Number	Stud Center to Stud Center	OEM Reference	Notes
5000	1967-77	E-5310	16.64"	C7TZ-3304A	

B600, B6000

King Pin Kits

Axle Rating Lbs.	Axle Code/Year	Part Number/ Bushing Type	King Pin Size	Type	OEM Reference	Notes
5000	1961-85	E-4440B Bronze	1.231" x 7.860"	C	C3TZ-3111A	
5500	1963-85	E-4440B Bronze	1.231" x 7.860"	C	C3TZ-3111A	
6000	1967-88	E-4445B Bronze	1.231" x 8.910"	C	C7TZ-3111A	
		E-4445N Nylon				
	1989-99	E-6195B Bronze	1.299" x 7.748"	B	E8HZ-3111A	
7000	1961-66	E-4438B Bronze	1.234" x 7.438"	B	B7TZ-3111F	
		E-4438N Nylon				
	1967-75	E-4445B Bronze	1.231" x 8.910"	C	C7TZ-3111A	Before W40,001.
		E-4445N Nylon				
	1975-88	E-4452B Bronze	1.433" x 8.250"	B	D6TZ-3111A	From W40,001 w/air brakes.
	1980-88	E-4445B Bronze	1.231" x 8.910"	C	C7TZ-3111A	w/Hydraulic brakes.
		E-4445N Nylon				
	1989-97	E-6195B Bronze	1.299" x 7.748"	B	E8HZ-3111A	w/Air brakes.
7500	1980-86	E-4452B Bronze	1.433" x 8.250"	B	D6TZ-3111A	w/Air brakes.
8000	1984-90	E-4452B Bronze	1.433" x 8.250"	B	D6TZ-3111A	w/Air brakes.
	1989-99	E-9943B Bronze			E9HZ-3111C	
9000	1975-90	E-4452B Bronze	1.433" x 8.250"	B	D6TZ-3111A	
	1989-99	E-9943B Bronze			E9HZ-3111C	
14600	1995	E-9945B Bronze	1.810" x 10.531"	A	F5HZ-3111A	

FORD

B600, B6000 (Continued)

Tie Rod Ends

Axle Rating Lbs.	Axle Code/Year	Part Number/ Location	Stud Center to Rod End	OEM Reference	Notes	
4700	1957-62	E-4635 Curbside	3.50"	C1TZ-3A130A		
		E-4634 Roadside		C1TZ-3A131A		
5000	1961-66	E-4635 Curbside	3.50"	C1TZ-3A130A	w/Manual steering.	
		E-4634 Roadside		C1TZ-3A131A		
	1967-85	E-4605 Curbside	4.438"	C7TZ-3A130D		
		E-4604 Roadside		C7TZ-3A131D		
5500	1963-66	E-4635 Curbside	3.50"	C1TZ-3A130A	w/Manual steering.	
		E-4634 Roadside		C1TZ-3A131A		
	1967-83	E-4605 Curbside	4.438"	C7TZ-3A130D		
		E-4604 Roadside		C7TZ-3A131D		
6000	1967-89	E-4605 Curbside	4.438"	C7TZ-3A130D, E8HZ-3A130A		
		E-4604 Roadside		C7TZ-3A131D, E8HZ-3A131A		
	1990-98	E-4613 Curbside	4.938"	F0HZ-3A130C		
		E-4612 Roadside		F0HZ-3A131C		
		E-4623 Curbside	6.07"	F0HZ-3A131E		
		E-4622 Roadside		F0HZ-3A131F		
		E-6864 Curbside		13.25"		F0HZ-3A130D
	E-6863 Roadside	F0HZ-3A131D				
	1995-99	E-9966 Curbside	7.188"	F5HZ-3A131B		
		E-9965 Roadside		F5HZ-3A130B		
	7000	1961-66	E-4603 Curbside	3.875"	C1TZ-3A130B	
			E-4602 Roadside		C1TZ-3A131B	
1967-89		E-4605 Curbside	4.438"	C7TZ-3A130D	w/Hydraulic brakes.	
		E-4604 Roadside		C7TZ-3A131D		
1973-75		E-4605 Curbside		C7TZ-3A130D	w/Air brakes before W40,001.	
		E-4604 Roadside		C7TZ-3A131D		
1975-88		E-4623 Curbside	6.07"	D5TZ-3A131A	w/Air brakes from W40,001.	
		E-4622 Roadside		D5TZ-3A130A		
1990-94		E-4613 Curbside	4.938"	F0HZ-3A130C		
		E-4612 Roadside		F0HZ-3A131C		
		E-4623 Curbside	6.07"	F0HZ-3A131E		
		E-4622 Roadside		F0HZ-3A131F		
1990-97		E-6864 Curbside	13.25"	F0HZ-3A130D	Low profile.	
		E-6863 Roadside		F0HZ-3A131D		
1995-99		E-9963 Curbside	6.00"	F3HZ-3A130B		
		E-9962 Roadside		F3HZ-3A131B		
	E-9966 Curbside	7.188"	F5HZ-3A131B			
	E-9965 Roadside		F5HZ-3A130B			
7500	1980-89	E-4623 Curbside	6.07"	D5TZ-3A131A	w/Air brakes.	
		E-4622 Roadside		D5TZ-3A130A		
	1990-92	E-4623 Curbside		F0HZ-3A131B		
		E-4622 Roadside		F0HZ-3A130B		
8000	1984-98	E-4623 Curbside	6.07"	F0HZ-3A131B, D5TZ-3A131A		
		E-4622 Roadside		F0HZ-3A130B, D5TZ-3A130A		
	1995-98	E-9966 Curbside	7.188"	F5HZ-3A131B		
		E-9965 Roadside		F5HZ-3A130B		

B600, B6000 (Continued)

Tie Rod Ends (Continued)

Axle Rating Lbs.	Axle Code/Year	Part Number/Location	Stud Center to Rod End	OEM Reference	Notes
9000	1975-94	E-4623 Curbside	6.07"	F0HZ-3A131B, D5TZ-3A131A	
		E-4622 Roadside		F0HZ-3A130B, D5TZ-3A130A	
	1995-98	E-9966 Curbside	7.188"	F5HZ-3A131B	
		E-9965 Roadside		F5HZ-3A130B	
14600	1995-98	E-9963 Curbside	6.00"	F3HZ-3A130B	
		E-9962 Roadside		F3HZ-3A131B	

Drag Links

Axle Rating Lbs.	Axle Code/Year	Part Number	Stud Center to Stud Center	OEM Reference	Notes
5000, 5500	1967-79	E-5310	16.64"	C7TZ-3304A	
6000	1967-79	E-5310	16.64"	C7TZ-3304A	w/Manual steering.
	1980-88	E-5338	19.25"	E0HZ-3304A	To 12/87.
	1989-92	E-6827	20.66"	E8HZ-3304B, F0HZ-3304G	
7000	1995-98	E-9937	21.23"	F5HZ-3304A	
	1967-79	E-5310	16.64"	C7TZ-3304A	w/Manual steering.
	1980-88	E-5338	19.25"	E0HZ-3304A	To 12/87.
	1989-92	E-6827	20.66"	E8HZ-3304B, F0HZ-3304G	
	1995-98	E-9937	21.23"	F5HZ-3304A	
7500	1980-88	E-5338	19.25"	E0HZ-3304A	
8000	1980-87	E-5339	19.23"	E0HZ-3304B	
	1992-93	E-9934	19.47"	F2HZ-3304D	Before 5/93.
	1993-98	E-9936	19.43"	F4HZ-3304A	After 5/93.
9000	1980-87	E-5339	19.23"	E0HZ-3304B	
	1992-93	E-9934	19.47"	F2HZ-3304D	Before 5/93.
	1993-98	E-9936	19.43"	F4HZ-3304A	After 5/93.
10000, 12000	1990-91	E-6836	19.23"	F0HZ-3304A	

S.O.S.

Special Order Service

Can't find it?

Trouble sourcing products?

Need assistance?

*Let Euclid's Special Order Service (**S.O.S.**) help you find your parts.*

Euclid's position as the market leader provides you access to a comprehensive array of truck parts products from the industry's leading manufacturers. Through Euclid, these entire product lines are available to you just by placing a phone call to Euclid's S.O.S. Department at 866-238-2543 (option 2) in the U.S. or 800-387-3889 in Canada.

FORD

B700, B750, B7000

King Pin Kits

Axle Rating Lbs.	Axle Code/Year	Part Number/ Bushing Type	King Pin Size	Type	OEM Reference	Notes
5000, 5500	1961-76	E-4440B Bronze	1.231" x 7.860"	C	C3TZ-3111A	
6000	1967-88	E-4445B Bronze	1.231" x 8.910"	C	C7TZ-3111A	
		E-4445N Nylon				
7000	1989-99	E-6195B Bronze	1.299" x 7.748"	B	E8HZ-3111A	
	1967-75	E-4445B Bronze	1.231" x 8.910"	C	C7TZ-3111A	1973-83 w/hydraulic brakes.
		E-4445N Nylon				
		E-4445B Bronze				
	1967-86	E-4445N Nylon				
	1975	E-4452B Bronze	1.433" x 8.250"	B	D6TZ-3111A	w/Air brakes from W40,001.
	1980-88	E-4452B Bronze				w/Air brakes.
1989-97	E-6195B Bronze	1.299" x 7.748"	B	E8HZ-3111A	w/Air brakes.	
7500	1980-86	E-4452B Bronze	1.433" x 8.250"	B	D6TZ-3111A	w/Air brakes.
8000	1984-90	E-4452B Bronze	1.433" x 8.250"	B	D6TZ-3111A	w/Air brakes.
	1989-99	E-9943B Bronze				
9000	1971-78	E-4441B Bronze	1.434" x 8.500"	B	D1HZ-3111A	
	1977-90	E-4452B Bronze	1.433" x 8.250"	B	D6TZ-3111A	
	1989-99	E-9943B Bronze			E9HZ-3111C	w/Air brakes from 2/91.
14600	1995	E-9945B Bronze	1.810" x 10.531"	A	F5HZ-3111A	

Tie Rod Ends

Axle Rating Lbs.	Axle Code/Year	Part Number/ Location	Stud Center to Rod End	OEM Reference	Notes	
5000	1967-76	E-4605 Curbside	4.438"	C7TZ-3A130D		
		E-4604 Roadside		C7TZ-3A131D		
5500	1961-66	E-4635 Curbside	3.50"	C1TZ-3A130A	w/Manual steering.	
		E-4634 Roadside		C1TZ-3A131A		
	1967-76	E-4605 Curbside	4.438"	C7TZ-3A130D		
		E-4604 Roadside		C7TZ-3A131D		
6000	1967-89	E-4605 Curbside	4.438"	C7TZ-3A130D, E8HZ-3A130A		
		E-4604 Roadside		C7TZ-3A131D, E8HZ-3A131A		
	1990-98	E-4613 Curbside	4.938"	F0HZ-3A130C		
		E-4612 Roadside		F0HZ-3A131C		
		E-4623 Curbside	6.07"	F0HZ-3A131E		
		E-4622 Roadside		F0HZ-3A131F		
		E-6864 Curbside	13.25"	F0HZ-3A130D		Low profile.
		E-6863 Roadside		F0HZ-3A131D		
	1995-99	E-9963 Curbside	6.00"	F3HZ-3A130B		
		E-9962 Roadside		F3HZ-3A131B		
		E-9966 Curbside	7.188"	F5HZ-3A131B		
		E-9965 Roadside		F5HZ-3A130B		



an **ArvinMeritor**™ brand

B700, B750, B7000 (Continued)

Tie Rod Ends (Continued)

Axle Rating Lbs.	Axle Code/Year	Part Number/ Location	Stud Center to Rod End	OEM Reference	Notes
7000	1967-75	E-4605 Curbside	4.438"	C7TZ-3A130D	w/Air brakes to W40,001.
		E-4604 Roadside		C7TZ-3A131D	
	1967-88	E-4605 Curbside	6.07"	C7TZ-3A130D	1973-83 w/hydraulic brakes.
		E-4604 Roadside		C7TZ-3A131D	
	1975-88	E-4623 Curbside	6.07"	D5TZ-3A131A	w/Air brakes from W40,001.
		E-4622 Roadside		D5TZ-3A130A	
	1989	E-4605 Curbside	4.438"	C7TZ-3A130D, E8HZ-3A130A	w/Air brakes.
		E-4604 Roadside		C7TZ-3A131D, E8HZ-3A131A	
	1990-94	E-4623 Curbside	6.07"	F0HZ-3A131E, D5TZ-3A130A	
		E-4622 Roadside		F0HZ-3A131F, D5TZ-3A131A	
	1990-97	E-6864 Curbside	13.25"	F0HZ-3A130D	Low profile.
		E-6863 Roadside		F0HZ-3A131D	
1995-99	E-9963 Curbside	6.00"	F3HZ-3A130B		
	E-9962 Roadside		F3HZ-3A131B		
	E-9966 Curbside	7.188"	F5HZ-3A131B		
	E-9965 Roadside		F5HZ-3A130B		
7500	1977-86	E-4623 Curbside	6.07"	D5TZ-3A131A	w/Air brakes.
		E-4622 Roadside		D5TZ-3A130A	
8000	1984-98	E-4623 Curbside	6.07"	D5TZ-3A131A	
		E-4622 Roadside		D5TZ-3A130A	
	1995-99	E-9966 Curbside	7.188"	F5HZ-3A131B	
		E-9965 Roadside		F5HZ-3A130B	
9000	1977-94	E-4623 Curbside	6.07"	D5TZ-3A131A	
		E-4622 Roadside		D5TZ-3A130A	
	1995-98	E-9966 Curbside	7.188"	F5HZ-3A131B	
		E-9965 Roadside		F5HZ-3A130B	
14600	1995-98	E-9963 Curbside	6.00"	F3HZ-3A130B	
		E-9962 Roadside		F3HZ-3A131B	

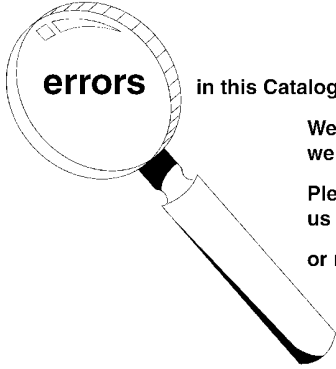

If you detect any **errors** in this Catalog, please let us know.

We want the information to be as accurate as possible; we appreciate your help in making it so.

Please e-mail any comments/suggestions/corrections to us at: catalogfeedback@arvinmeritor.com

or mail to: **Euclid Industries, LLC**
Attn: Catalog Dept.
7975 Dixie Highway
Florence, KY 41042-2754

FORD

B700, B750, B7000 (Continued)

Drag Links

Axle Rating Lbs.	Axle Code/Year	Part Number	Stud Center to Stud Center	OEM Reference	Notes
5000, 5500	1973-75	E-5310	16.64"	C7TZ-3304A	To W20,001.
6000	1967-68	E-5310	16.64"	C7TZ-3304A	w/Power steering.
	1967-75	E-5310			w/Manual steering.
	1977-79	E-5310			w/Hydraulic brakes.
	1980-87	E-5338	19.25"	E0HZ-3304A	
	1989-92	E-6827	20.66"	E8HZ-3304B, F0HZ-3304G	
	1995-98	E-9937	21.23"	F5HZ-3304A	
7000	1967-68	E-5310	16.64"	C7TZ-3304A	w/Power steering.
	1967-72	E-5310			w/Manual steering.
	1973-75	E-5310			w/Power steering to W20,001.
	1980-87	E-5338	19.25"	E0HZ-3304A	
	1989-92	E-6827	20.66"	E8HZ-3304B, F0HZ-3304G	
	1995-98	E-9937	21.23"	F5HZ-3304A	
7500	1980-88	E-5338	19.25"	E0HZ-3304A	
8000	1980-87	E-5339	19.23"	E3HZ-3304B, E0HZ-3304B	
	1992-93	E-9934	19.47"	F2HZ-3304D	Before 5/93.
	1993-98	E-9936	19.43"	F4HZ-3304A	After 5/93.
9000	1977-79	E-5310	16.64"	C7TZ-3304A	w/Hydraulic brakes.
	1980-87	E-5339	19.23"	E3HZ-3304B, E0HZ-3304B	
	1992-93	E-9934	19.47"	F2HZ-3304D	Before 5/93.
	1993-98	E-9936	19.43"	F4HZ-3304A	After 5/93.
10000, 12000	1990-91	E-6836	19.23"	F0HZ-3304A	

S.O.S.

Special Order Service

Can't find it?

Trouble sourcing products?

Need assistance?

Let Euclid's Special Order Service (S.O.S.) help you find your parts.

Euclid's position as the market leader provides you access to a comprehensive array of truck parts products from the industry's leading manufacturers. Through Euclid, these entire product lines are available to you just by placing a phone call to Euclid's S.O.S. Department at 866-238-2543 (option 2) in the U.S. or 800-387-3889 in Canada.

C500, C550, C600, CT600, C700, CT700, C7000, C750, CT750, C800, C8000, CT800, CT8000, C850, CT850, C900, CT900, C9000, CT9000, C950, CT950, C1000, C1100

King Pin Kits

Axle Rating Lbs.	Axle Code/Year	Part Number/ Bushing Type	King Pin Size	Type	OEM Reference	Notes
6000	1968-70	E-4438B Bronze	1.234" x 7.438"	B	B7TZ-3111F	From C70,001-G90,001.
		E-4438N Nylon			C2TZ-3111F	
	1970-79	E-4445B Bronze	1.231" x 8.910"	C	C7TZ-3111A	From G90,001.
		E-4445N Nylon				
7000	1957-70	E-4438B Bronze	1.234" x 7.438"	B	B7TZ-3111F	Before G90,001.
		E-4438N Nylon			C2TZ-3111F	
	1970-89	E-4445B Bronze	1.231" x 8.910"	C	C7TZ-3111A	w/Hydraulic brakes from G90,001 or w/Air brakes from G90,001 - W40,001.
		E-4445N Nylon				
	1975-90	E-4452B Bronze	1.433" x 8.250"	B	D6TZ-3111A	w/Air brakes from W40,001.
8000	1989-99	E-9943B Bronze	1.433" x 8.250"	B	E9HZ-3111C	Air brakes from 2/91.
9000	1960-90	E-4441B Bronze	1.434" x 8.500"	B	C2TZ-3111G, D1HZ-3111A	w/Hydraulic brakes.
	1970-81	E-4445B Bronze	1.231" x 8.910"	C	C7TZ-3111A	w/Hydraulic brakes from 1973, 1970-72 all brakes.
		E-4445N Nylon				
	1973-90	E-4457B Bronze	1.607" x 9.080"	B	D6HZ-3111B	w/Air brakes from W40,001.
	1980-86	E-4459C Composite	1.794" x 10.070"		D6HZ-3111C	w/Air brakes.
	1987-89	E-4452B Bronze	1.433" x 8.250"	D6TZ-3111A		
	1989-99	E-9943B Bronze		E9HZ-3111C	Air brakes from 2/91.	
	1990	E-4457B Bronze	1.607" x 9.080"	D6HZ-3111B		
E-4459C Composite		1.794" x 10.070"	D6HZ-3111C			
10000	1990	E-6196B Bronze	1.794" x 10.070"	B	F0HZ-3111A	Aluminum axle.
11000	1964-78	E-4449B Bronze	1.607" x 8.740"	B	C4TZ-3111A, DOHZ-3111A	Center point steering.
12000	1960-79	E-4442B Bronze	1.794" x 9.120"	B	D1HZ-3111B	w/Hydraulic brakes from 1973.
	1966-78	E-4449B Bronze	1.607" x 8.740"		C4TZ-3111A, D0HZ-3111C	Center point steering.
	1973-75	E-4442B Bronze	1.794" x 9.120"		D1HZ-3111B	w/Air brakes from W40,001.
	1975-79	E-4457B Bronze	1.607" x 9.080"		D6HZ-3111B	
	1975-90	E-4459B Bronze	1.794" x 10.070"		D6HZ-3111A	Except aluminum axle. Bearing 3.26" OD x .94" thick.
	1980-89	E-4457B Bronze	1.607" x 9.080"		D6HZ-3111B	
1990	E-6196B Bronze	1.794" x 10.070"	F0HZ-3111A	Aluminum axle.		
14600	1995-98	E-9945B Bronze	1.810" x 10.531"	A	F5HZ-3111A	
15000	1975-79	E-4458B Bronze	1.999" x 11.212"	B	D5HZ-3111C	w/Air brakes from W40,001.
		E-4458C Composite				
16000	1975-90	E-4458B Bronze	1.999" x 11.212"	B	D5HZ-3111C	
		E-4458C Composite				
18000	1975-90	E-4458B Bronze	1.999" x 11.212"	B	D5HZ-3111C	w/Air brakes from W40,001.
		E-4458C Composite				



an **ArvinMeritor**™ brand

FORD

C500, C550, C600, CT600, C700, CT700, C7000, C750, CT750, C800, C8000, CT800, CT8000, C850, CT850, C900, CT900, C9000, CT9000, C950, CT950, C1000, C1100 (Continued)

Tie Rod Ends

Axle Rating Lbs.	Axle Code/Year	Part Number/ Location	Stud Center to Rod End	OEM Reference	Notes
5000	1961-66	E-4635 Curbside	3.50"	C1TZ-3A130A	w/Manual steering.
		E-4634 Roadside		C1TZ-3A131A	
5500	1963-66	E-4635 Curbside	3.50"	C1TZ-3A130A	w/Manual steering.
		E-4634 Roadside		C1TZ-3A131A	
	1967-79	E-4605 Curbside	4.438"	C7TZ-3A130D	
		E-4604 Roadside		C7TZ-3A131D	
6000	1968-70	E-4603 Curbside	3.875"	C1TZ-3A130B	From C70,001-G90,001, C550 only.
		E-4602 Roadside		C1TZ-3A131B	
	1970-79	E-4605 Curbside	4.438"	C7TZ-3A130D	
		E-4604 Roadside		C7TZ-3A131D	
7000	1953-70	E-4603 Curbside	3.875"	C1TZ-3A130B	To G90,001.
		E-4602 Roadside		C1TZ-3A131B	
	1970-89	E-4605 Curbside	4.438"	C7TZ-3A130D	w/Hydraulic brakes from G90,001.
		E-4604 Roadside		C7TZ-3A131D	
	1971-75	E-4605 Curbside		C7TZ-3A130D	w/Air brakes to W40,001.
		E-4604 Roadside		C7TZ-3A131D	
	1975-89	E-4623 Curbside	6.07"	D5TZ-3A131A	w/Air brakes from W40,001.
		E-4622 Roadside		D5TZ-3A130A	
9000	1960-89	E-4611 Curbside	4.875"	C8TZ-3A130A	
		E-4610 Roadside		C1TZ-3A131C	
	1975-90	E-4623 Curbside	6.07"	D5TZ-3A131A	
		E-4622 Roadside		D5TZ-3A130A	
10000, 11000	1990	E-4615 Curbside	5.44"	E3HZ-3A130A, E4HZ-3A130A	w/Aluminum axle.
		E-4614 Roadside		E3HZ-3A131A, E4HZ-3A131A	
12000	1961-70	E-4618 Curbside	5.75"	B8TZ-3A131B	Before G70,001.
		E-4619 Roadside		B8TZ-3A130B	
	1970-80	E-4617 Curbside		D0HZ-3A130C	
		E-4616 Roadside		D0HZ-3A131C	
	1975-90	E-4615 Curbside	5.44"	D0HZ-3A130A	
		E-4614 Roadside		D0HZ-3A131A	
	1980-90	E-4615 Curbside		E3HZ-3A130A, E4HZ-3A130A	w/Aluminum axle.
		E-4614 Roadside		E3HZ-3A131A, E4HZ-3A131A	
15000	1964-70	E-4618 Curbside	5.75"	B8TZ-3A131B	
		E-4619 Roadside		B8TZ-3A130B	
	1964-75	E-4617 Curbside		D0HZ-3A130C	
		E-4616 Roadside		D0HZ-3A131C	
	1975-80	E-4615 Curbside	5.44"	E3HZ-3A130A, E4HZ-3A130A	w/Air brakes from W40,001.
		E-4614 Roadside		E3HZ-3A131A, E4HZ-3A131A	
16000	1975-89	E-4615 Curbside	5.44"	D0HZ-3A130A	w/Air brakes from W40,001. 1980-81 all brakes.
		E-4614 Roadside		D0HZ-3A131A	
	1975-90	E-4615 Curbside		E3HZ-3A130A, E4HZ-3A130A	
		E-4614 Roadside		E3HZ-3A131A, E4HZ-3A131A	

C500, C550, C600, CT600, C700, CT700, C7000, C750, CT750, C800, C8000, CT800, CT8000, C850, CT850, C900, CT900, C9000, CT9000, C950, CT950, C1000, C1100 (Continued)

Tie Rod Ends (Continued)

Axle Rating Lbs.	Axle Code/Year	Part Number/ Location	Stud Center to Rod End	OEM Reference	Notes
18000	1975-89	E-4615 Curbside	5.44"	D0HZ-3A130A	From W40,001.
		E-4614 Roadside		D0HZ-3A131A	
	1975-90	E-4615 Curbside	5.44"	E3HZ-3A130A, E4HZ-3A130A	
		E-4614 Roadside		E3HZ-3A131A, E4HZ-3A131A	
1998	E-9966 Curbside	7.188"	F5HZ-3A131B		
	E-9965 Roadside		F5HZ-3A130B		
20000	1998	E-9966 Curbside	7.188"	F5HZ-3A131B	
		E-9965 Roadside		F5HZ-3A130B	

Drag Links

Axle Rating Lbs.	Axle Code/Year	Part Number	Stud Center to Stud Center	OEM Reference	Notes
6000	1980-87	E-5338	19.25"	E0HZ-3304A	
7000, 7500	1980-86	E-5338	19.25"	E0HZ-3304A	
8000, 9000	1980-86	E-5339	19.23"	E3HZ-3304B	

CF600, CF700

King Pin Kits

Axle Rating Lbs.	Axle Code/Year	Part Number/ Bushing Type	King Pin Size	Type	OEM Reference	Notes
9000	1986-89	E-4457B Bronze	1.607" x 9.080"	B	D6HZ-3111B	
		E-4459C Composite	1.794" x 10.070"		D6HZ-3111C	
	1989-98	E-6197B Bronze	1.607" x 9.080"	E9HZ-3111B	w/Screw-in end caps.	
11000	1987-89	E-4459B Bronze	1.794" x 10.070"	B	D6HZ-3111A	Bearing 3.26" OD x .94" thick.
12000	1986-90	E-4459B Bronze	1.794" x 10.070"	B	D6HZ-3111A	Bearing 3.26" OD x .94" thick.
	1989-91	E-6196B Bronze			E9HZ-3111A	w/Screw-in end caps.
13000	1990-98	E-6196B Bronze	1.794" x 10.070"	B	E9HZ-3111A	w/Steel axle.

Tie Rod Ends

Axle Rating Lbs.	Axle Code/Year	Part Number/ Location	Stud Center to Rod End	OEM Reference	Notes
9000	1990-94	E-4623 Curbside	6.07"	F0HZ-3A131E, E6HZ-3A130A	
		E-4622 Roadside		F0HZ-3A131F, E6HZ-3A131A	
12000	1990-91	E-4615 Curbside	5.44"	E4HZ-3A130A	w/Steel axle.
		E-4614 Roadside		E4HZ-3A131A	
1992-94	1992-94	E-9963 Curbside	6.00"	F1HZ-3A130A, F3HZ-3A130B	
		E-9962 Roadside		F1HZ-3A131A, F3HZ-3A131B	
13000	1990-91	E-4615 Curbside	5.44"	E4HZ-3A130A	w/Steel axle.
		E-4614 Roadside		E4HZ-3A131A	
	1992-98	E-9963 Curbside	6.00"	F1HZ-3A130A, F3HZ-3A130B	
		E-9962 Roadside		F1HZ-3A131A, F3HZ-3A131B	

FORD

CF600, CF700 (Continued)

Drag Links

Axle Rating Lbs.	Axle Code/Year	Part Number	Stud Center to Stud Center	OEM Reference	Notes
9000, 12000, 13000	1991-94	E-9931	37.13"	F1HZ-3304L	

CF800, CFT800

King Pin Kits

Axle Rating Lbs.	Axle Code/Year	Part Number/ Bushing Type	King Pin Size	Type	OEM Reference	Notes
9000	1986-88	E-4459C Composite	1.794" x 10.070"	B	D6HZ-3111C	
	1986-89	E-4457B Bronze	1.607" x 9.080"		D6HZ-3111B	To 1/89
	1989-98	E-6197B Bronze			E9HZ-3111B	From 1/89, with screw-in end caps.
11000	1987-89	E-4459B Bronze	1.794" x 10.070"	B	D6HZ-3111A	Bearing 3.26" OD x .94" thick.
12000	1986-89	E-4459B Bronze	1.794" x 10.070"	B	D6HZ-3111A	Bearing 3.26" OD x .94" thick.
	1989-91	E-6196B Bronze			E9HZ-3111A	w/Screw-in end caps.
13000	1987-90	E-4459B Bronze	1.794" x 10.070"	B	D6HZ-3111A	Bearing 3.26" OD x .94" thick.
	1990-91	E-6196B Bronze			E9HZ-3111A	w/Steel axle.

Tie Rod Ends

Axle Rating Lbs.	Axle Code/Year	Part Number/ Location	Stud Center to Rod End	OEM Reference	Notes
9000	1986-94	E-4623 Curbside	6.07"	F0HZ-3A131B	
		E-4622 Roadside		F0HZ-3A130B	
	1995-98	E-9966 Curbside	7.188"	F5HZ-3A131B	
		E-9965 Roadside		F5HZ-3A130B	
11000	1987-98	E-4623 Curbside	6.07"	F0HZ-3A131B, E6HZ-3A130A	
		E-4622 Roadside		F0HZ-3A130B, E6HZ-3A131A	
12000	1986-98	E-4623 Curbside	6.07"	F0HZ-3A131B, E6HZ-3A130A	
		E-4622 Roadside		F0HZ-3A130B, E6HZ-3A131A	
	1990-91	E-4615 Curbside	5.44"	E4HZ-3A130A	
		E-4614 Roadside		E4HZ-3A131A	
	1992-94	E-9963 Curbside	6.00"	F1HZ-3A130A, F3HZ-3A130B	
		E-9962 Roadside		F1HZ-3A131A, F3HZ-3A131B	
13000	1987-92	E-4623 Curbside	6.07"	F0HZ-3A131B, E6HZ-3A130	
		E-4622 Roadside		F0HZ-3A130B, E6HZ-3A131A	
	1990-91	E-4615 Curbside	5.44"	E4HZ-3A130A	
		E-4614 Roadside		E4HZ-3A131A	
	1992-98	E-9963 Curbside	6.00"	F1HZ-3A130A, F3HZ-3A130B	
		E-9962 Roadside		F1HZ-3A131A, F3HZ-3A131B	

Drag Links

Axle Rating Lbs.	Axle Code/Year	Part Number	Stud Center to Stud Center	OEM Reference	Notes
9000, 12000, 13000	1991-98	E-9931	37.13"	F1HZ-3304L	

CL900, CLT900, CL9000, CLT9000

King Pin Kits

Axle Rating Lbs.	Axle Code/Year	Part Number/ Bushings Type	King Pin Size	Type	OEM Reference	Notes
11000	1987-89	E-4459B Bronze	1.794" x 10.070"	B	D6HZ-3111A	Bearing 3.26" OD x .94" thick. w/Steel or aluminum axle.
12000	1978-86	E-4459B Bronze	1.794" x 10.070"	B	D6HZ-3111A	Bearing 3.26" OD x .94" thick. w/Steel axle.
	1987-88	E-4459B Bronze				Bearing 3.26" OD x .94" thick. w/Steel or aluminum axle.
	1989-91	E-6196B Bronze				w/Screw-in end caps and steel axle.
13000	1978-88	E-4459B Bronze	1.794" x 10.070"	B	D6HZ-3111A	Bearing 3.26" OD x .94" thick. w/Steel axle.
	1989	E-6196B Bronze				E9HZ-3111A

Tie Rod Ends

Axle Rating Lbs.	Axle Code/Year	Part Number/ Location	Stud Center to Rod End	OEM Reference	Notes
11000	1987-89	E-4615 Curbside	5.44"	E3HZ-3A130A	w/Steel or aluminum axles.
		E-4614 Roadside		E3HZ-3A131A	
12000	1978-91	E-4615 Curbside	5.44"	D0HZ-3A130A	w/Steel or aluminum axles.
		E-4614 Roadside		D0HZ-3A131A	
13000	1980-86	E-4615 Curbside	5.44"	D0HZ-3A130A	
		E-4614 Roadside		D0HZ-3A131A	

F1000, F1100

King Pin Kits

Axle Rating Lbs.	Axle Code/Year	Part Number/ Bushings Type	King Pin Size	Type	OEM Reference	Notes
9000	1962-69	E-4441B Bronze	1.434" x 8.500"	B	D1HZ-3111A	
11000	1964-65	E-4449B Bronze	1.607" x 8.740"	B	D0HZ-3111C	Center point steering.
12000	1962-69	E-4442B Bronze	1.794" x 9.120"	B	D1HZ-3111B	
	1966-69	E-4449B Bronze	1.607" x 8.740"	B	D0HZ-3111C	Center point steering.

Tie Rod Ends

Axle Rating Lbs.	Axle Code/Year	Part Number/ Location	Stud Center to Rod End	OEM Reference	Notes
9000	1962-69	E-4611 Curbside	4.875"	C8TZ-3A130A	
		E-4610 Roadside		C1TZ-3A131C	
12000, 15000	1962-69	E-4618 Curbside	5.75"	B8TZ-3A131B	
		E-4619 Roadside		B8TZ-3A130B	



an **ArvinMeritor**™ brand

FORD

F600, F6000, FT600, FT6000, F700, F7000, FT700

King Pin Kits

Axle Rating Lbs.	Axle Code/Year	Part Number/ Bushing Type	King Pin Size	Type	OEM Reference	Notes			
5000	1961-79	E-4440B Bronze	1.231" x 7.860"	C	C3TZ-3111A				
5500	1961-86	E-4440B Bronze	1.231" x 7.860"	C	C3TZ-3111A				
6000	1967-88	E-4445B Bronze	1.231" x 8.910"	C	C7TZ-3111A				
		E-4445N Nylon							
7000	1989-99	E-6195B Bronze	1.299" x 7.748"	B	E8HZ-3111A	To G90,001.			
		E-4438B Bronze	1.234" x 7.438"	B	B7TZ-3111F				
	E-4438N Nylon	C2TZ-3111F							
	1967-75	E-4445B Bronze	1.231" x 8.910"	C	C7TZ-3111A	w/Air brakes before W40,001.			
		E-4445N Nylon							
	1970-88	E-4445B Bronze				w/Hydraulic brakes from G90,001.			
		E-4445N Nylon							
	1975-88	E-4452B Bronze	1.433" x 8.250"	B	D6TZ-3111A	w/Air brakes from W40,001.			
E-6195B Bronze		1.299" x 7.748"	E8HZ-3111A		w/Hydraulic brakes.				
8000	1987-90	E-4452B Bronze	1.433" x 8.250"	B	E7TZ-3111A	w/Air brakes.			
	1989-99	E-9943B Bronze			E9HZ-3111C	w/Air brakes from 2/91.			
9000	1975-90	E-4452B Bronze	1.433" x 8.250"	B	D6TZ-3111A	w/Air brakes from W40,001; 1980-84 all brakes.			
		1983				E-4459C Composite	1.794" x 10.070"	D6HZ-3111C	w/Air brakes.
		1983-90				E-4457B Bronze	1.607" x 9.080"	D6HZ-3111B	Heavy duty w/air brakes.
		1989-99				E-9943B Bronze	1.433" x 8.250"	E9HZ-3111C	w/Air brakes from 2/91.
10000	1987-90	E-4459B Bronze	1.794" x 10.070"	B	D6HZ-3111A	Except aluminum axle.			
	1990-99	E-6196B Bronze			E9HZ-3111A	w/Steel axle.			
12000	1982-88	E-4459B Bronze	1.794" x 10.070"	B	D6HZ-3111A				
	1989-94	E-6196B Bronze			E9HZ-3111A		w/Screw-in end caps.		
14600	1995	E-9945B Bronze	1.810" x 10.531"	A	F5HZ-3111A				

Tie Rod Ends

Axle Rating Lbs.	Axle Code/Year	Part Number/ Location	Stud Center to Rod End	OEM Reference	Notes
4700	1957-62	E-4635 Curbside	3.50"	C1TZ-3A130A	
		E-4634 Roadside		C1TZ-3A131A	
5000	1953-66	E-4635 Curbside	3.50"	C1TZ-3A130A	w/Manual steering.
		E-4634 Roadside		C1TZ-3A131A	
	1967-79	E-4605 Curbside	4.438"	C7TZ-3A130D	
		E-4604 Roadside		C7TZ-3A131D	
5500	1961-66	E-4635 Curbside	3.50"	C1TZ-3A130A	w/Manual steering.
		E-4634 Roadside		C1TZ-3A131A	
	1967-86	E-4605 Curbside	4.438"	C7TZ-3A130D	
E-4604 Roadside		C7TZ-3A131D			
6000	1967-90	E-4605 Curbside	4.438"	C7TZ-3A130D	
		E-4604 Roadside		C7TZ-3A131D	
	1990	E-4613 Curbside	4.938"	F0HZ-3A130C	Except low profile option.
		E-4612 Roadside		F0HZ-3A131C	
	1990-93	E-6864 Curbside	13.25"	F0HZ-3A131D	
		E-6863 Roadside		F0HZ-3A130D	
	1990-94	E-4623 Curbside	6.07"	F0HZ-3A131E	
		E-4622 Roadside		F0HZ-3A131F	
1995	E-9966 Curbside	7.188"	F5HZ-3A131B		
	E-9965 Roadside		F5HZ-3A130B		

F600, F6000, FT600, FT6000, F700, F7000, FT700 (Continued)

Tie Rod Ends (Continued)

Axle Rating Lbs.	Axle Code/Year	Part Number/ Location	Stud Center to Rod End	OEM Reference	Notes	
7000	1961-66	E-4603 Curbside	3.875"	C1TZ-3A130B		
		E-4602 Roadside		C1TZ-3A131B		
	1967-90	E-4605 Curbside	4.438"	C7TZ-3A130D	w/Hydraulic brakes; 1989-90 except low profile option.	
		E-4604 Roadside		C7TZ-3A131D		
	1973-75	E-4605 Curbside		C7TZ-3A130D	w/Air brakes to W40,001.	
		E-4604 Roadside		C7TZ-3A131D		
	1975-88	E-4623 Curbside	6.07"	D5TZ-3A131A	w/Air brakes from W40,001.	
		E-4622 Roadside		D5TZ-3A130A		
	1990-94	E-4623 Curbside		F0HZ-3A131E		
		E-4622 Roadside		F0HZ-3A131F		
	1990-97	E-6864 Curbside	13.25"	F0HZ-3A131D	w/Hydraulic brakes and low profile option.	
		E-6863 Roadside		F0HZ-3A130D		
	1995	E-9966 Curbside	7.188"	F5HZ-3A131B		
		E-9965 Roadside		F5HZ-3A130B		
1995-99	E-9963 Curbside	6.00"	F3HZ-3A130B			
	E-9962 Roadside		F3HZ-3A131B			
8000	1987-98	E-4623 Curbside	6.07"	D5TZ-3A131A		
		E-4622 Roadside		D5TZ-3A130A		
	1995-99	E-9966 Curbside	7.188"	F5HZ-3A131B		
		E-9965 Roadside		F5HZ-3A130B		
9000	1968-79	E-4611 Curbside	4.875"	C8TZ-3A130A	w/Hydraulic brakes from 1973. w/Manual steering only.	
		E-4610 Roadside		C1TZ-3A131C		
	1973-75	E-4611 Curbside		C8TZ-3A130A	w/Air brakes to W40,001. w/Manual steering only.	
		E-4610 Roadside		C1TZ-3A131C		
	1975-94	E-4623 Curbside	6.07"	D5TZ-3A131A		
		E-4622 Roadside		D5TZ-3A130A		
1995-99	E-9966 Curbside	7.188"	F5HZ-3A131B			
	E-9965 Roadside		F5HZ-3A130B			
10000	1987-98	E-4615 Curbside	5.44"	E3HZ-3A130A, E4HZ-3A130A		
		E-4614 Roadside		E3HZ-3A131A, E4HZ-3A131A		
	1992-98	E-9963 Curbside	6.00"	F1HZ-3A130A, F3HZ-3A130B		
		E-9962 Roadside		F1HZ-3A131A, F3HZ-3A131B		
	12000	1982-98	E-4615 Curbside	5.44"	E3HZ-3A130A, E4HZ-3A130A	
			E-4614 Roadside		E3HZ-3A131A, E4HZ-3A131A	
1992-98		E-9963 Curbside	6.00"	F1HZ-3A130A, F3HZ-3A130B		
		E-9962 Roadside		F1HZ-3A131A, F3HZ-3A131B		
1995-99	E-11788 Curbside	7.75"	F5HZ-3A130AA			
	E-11789 Roadside		F5HZ-3A131AA			
14600	1995-98	E-9963 Curbside	6.00"	F3HZ-3A130B		
		E-9962 Roadside		F3HZ-3A131B		

FORD

F600, F6000, FT600, FT6000, F700, F7000, FT700 (Continued)

Drag Links

Axle Rating Lbs.	Axle Code/Year	Part Number	Stud Center to Stud Center	OEM Reference	Notes
5000	1967-79	E-5310	16.64"	C7TZ-3304A	
5500	1967-79	E-5310	16.64"	C7TZ-3304A	
	1980-86	E-5338	19.25"	E0HZ-3304A	
6000	1967-68	E-5310	16.64"	C7TZ-3304A	w/Power steering.
	1967-79	E-5310			w/Manual steering.
	1973-79	E-5310			
	1980-88	E-5338	19.25"	E0HZ-3304A	
	1989-92	E-6827	20.66"	E8HZ-3304B, F0HZ-3304G	
	1995-98	E-9937	21.23"	F5HZ-3304A	
7000	1967-68	E-5310	16.64"	C7TZ-3304A	w/Power steering.
	1967-79	E-5310			w/Manual steering to W20,001.
	1980-90	E-5338	19.25"	E0HZ-3304A	
	1989-92	E-6827	20.66"	E8HZ-3304B, F0HZ-3304G	w/Hydraulic brakes.
	1995-98	E-9937	21.23"	F5HZ-3304A	
8000	1984-87	E-5339	19.23"	E3HZ-3304B	w/Air brakes.
	1988-92	E-6827	20.66"	E8HZ-3304B	
	1992-93	E-9934	19.47"	F2HZ-3304D	Before 5/93
	1993-98	E-9936	19.43"	F4HZ-3304A	After 5/93.
9000	1980-87	E-5339	19.23"	E0HZ-3304B	
	1992-93	E-9934	19.47"	F2HZ-3304D	Before 5/93.
	1993-98	E-9936	19.43"	F4HZ-3304A	After 5/93.
10000	1987-91	E-6836	19.23"	E3HZ-3304A, F0HZ-3304A	
12000	1982-91	E-6836	19.23"	E3HZ-3304A, F0HZ-3304A	

F750

King Pin Kits

Axle Rating Lbs.	Axle Code/Year	Part Number/ Bushing Type	King Pin Size	Type	OEM Reference	Notes
7000	1960-70	E-4438B Bronze	1.234" x 7.438"	B	B7TZ-3111F	Before G90,001.
		E-4438N Nylon			C2TZ-3111F	
	1970-77	E-4445B Bronze	1.231" x 8.910"	C	C7TZ-3111A	w/Hydraulic brakes from G90,001.
		E-4445N Nylon				
	1973-88	E-4445B Bronze				w/Air brakes before W40,001.
		E-4445N Nylon				
9000	1973-75	E-4441B Bronze	1.434" x 8.500"	B	D1HZ-3111A	w/Air brakes before W40,001.
	1975-88	E-4452B Bronze	1.433" x 8.250"		D6TZ-3111A	w/Air brakes from W40,001.
	1989-99	E-9943B Bronze			E9HZ-3111C	w/Air brakes from 2/91.



F750 (Continued)

Tie Rod Ends

Axle Rating Lbs.	Axle Code/Year	Part Number/ Location	Stud Center to Rod End	OEM Reference	Notes	
7000	1961-66	E-4603 Curbside	3.875"	C1TZ-3A130B		
		E-4602 Roadside		C1TZ-3A131B		
	1967-88	E-4605 Curbside	4.438"	C7TZ-3A130D		w/Hydraulic brakes.
		E-4604 Roadside		C7TZ-3A131D		
	1973-75	E-4605 Curbside		C7TZ-3A130D		w/Air brakes before W40,001.
		E-4604 Roadside		C7TZ-3A131D		
9000	1973-75	E-4611 Curbside	4.875"	C8TZ-3A130A	w/Air brakes before W40,001.	
		E-4610 Roadside		C1TZ-3A131C	w/Manual steering only.	
	1975-77	E-4623 Curbside	6.07"	D5TZ-3A131A	w/Air brakes from W40,001.	
		E-4622 Roadside		D5TZ-3A130A		

Drag Links

Axle Rating Lbs.	Axle Code/Year	Part Number	Stud Center to Stud Center	OEM Reference	Notes
7000	1967-68	E-5310	16.64"	C7TZ-3304A	w/Power steering.
	1967-79	E-5310			w/Manual steering before W20,001.

F800, FT800, F880, F8000

King Pin Kits

Axle Rating Lbs.	Axle Code/Year	Part Number/ Bushing Type	King Pin Size	Type	OEM Reference	Notes	
5500	1980-83	E-4440B Bronze	1.231" x 7.860"	C	C3TZ-3111A		
6000	1984-90	E-4445B Bronze	1.231" x 8.910"	C	C7TZ-3111A		
		E-4445N Nylon					
7000	1989-99	E-6195B Bronze	1.299" x 7.748"	B	E8HZ-3111A		
	1960-70	E-4438B Bronze	1.234" x 7.438"	B	B7TZ-3111F	Before G90,001.	
		E-4438N Nylon			C2TZ-3111F		
	1970-88	E-4445B Bronze	1.231" x 8.910"	C	C7TZ-3111A	w/Hydraulic brakes from G90,001.	
		E-4445N Nylon					
	1973-75	E-4445B Bronze					w/Air brakes before W40,001.
		E-4445N Nylon					
	1980-88	E-4452B Bronze	1.433" x 8.250"	B	D6TZ-3111A	w/Air brakes.	
	1989-97	E-6195B Bronze	1.299" x 7.748"		E8HZ-3111A		
	8000	1989-99	E-9943B Bronze	1.433" x 8.250"	B	E9HZ-3111C	
9000	1973-75	E-4441B Bronze	1.434" x 8.500"	B	D1HZ-3111A	w/Air brakes before W40,001.	
		E-4452B Bronze	1.433" x 8.250"		D6TZ-3111A	w/Air brakes from W40,001; 1980-83 all brakes.	
	1983	E-4457B Bronze	1.607" x 9.080"		D6HZ-3111B	Heavy duty w/air brakes.	
		E-4459C Composite	1.794" x 10.070"		D6HZ-3111C		
	1989-99	E-9943B Bronze	1.433" x 8.250"		E9HZ-3111C	w/Air brakes from 2/91.	
10000	1987-90	E-4459B Bronze	1.794" x 10.070"	B	D6HZ-3111A	Except aluminum axle.	
	1990-94	E-6196B Bronze			E9HZ-3111A		w/Steel axle.
12000	1983-88	E-4459B Bronze	1.794" x 10.070"	B	D6HZ-3111A		
	1989-94	E-6196B Bronze			E9HZ-3111A		
14600	1995	E-9945B Bronze	1.810" x 10.531"	A	F5HZ-3111A		

FORD

F800, FT800, F880, F8000 (Continued)

Tie Rod Ends

Axle Rating Lbs.	Axle Code/Year	Part Number/Location	Stud Center to Rod End	OEM Reference	Notes
5500	1980-83	E-4605 Curbside	4.438"	C7TZ-3A130D	
		E-4604 Roadside		C7TZ-3A131D	
6000	1984-90	E-4605 Curbside	4.438"	C7TZ-3A130D	
		E-4604 Roadside		C7TZ-3A131D	
	1990	E-4613 Curbside	4.938"	F0HZ-3A130C	Except low profile option.
		E-4612 Roadside		F0HZ-3A131C	
	1990-94	E-4623 Curbside	6.07"	F0HZ-3A131E	
		E-4622 Roadside		F0HZ-3A131F	
	1990-98	E-6864 Curbside	13.25"	F0HZ-3A131D	w/Hydraulic brakes and low profile option.
		E-6863 Roadside		F0HZ-3A130D	
	1995	E-9966 Curbside	7.188"	F5HZ-3A131B	
		E-9965 Roadside		F5HZ-3A130B	
1995-99	E-9963 Curbside	6.00"	F3HZ-3A130B		
	E-9962 Roadside		F3HZ-3A131B		
7000	1961-66	E-4603 Curbside	3.875"	C1TZ-3A130B	
		E-4602 Roadside		C1TZ-3A131B	
	1967-90	E-4605 Curbside	4.438"	C7TZ-3A130D	w/Hydraulic brakes except low profile option.
		E-4604 Roadside		C7TZ-3A131D	
	1973-75	E-4605 Curbside		C7TZ-3A130D	w/Air brakes before W40,001.
		E-4604 Roadside		C7TZ-3A131D	
	1980-88	E-4623 Curbside	6.07"	D5TZ-3A131A	w/Air brakes.
		E-4622 Roadside		D5TZ-3A130A	
	1990-94	E-4623 Curbside		F0HZ-3A131E	
		E-4622 Roadside		F0HZ-3A131F	
	1990-98	E-6864 Curbside	13.25"	F0HZ-3A131D	w/Hydraulic brakes and low profile option.
		E-6863 Roadside		F0HZ-3A130D	
	1995	E-9966 Curbside	7.188"	F5HZ-3A131B	
		E-9965 Roadside		F5HZ-3A130B	
1995-99	E-9963 Curbside	6.00"	F3HZ-3A130B		
	E-9962 Roadside		F3HZ-3A131B		
8000	1987-98	E-4623 Curbside	6.07"	D5TZ-3A131A	
		E-4622 Roadside		D5TZ-3A130A	
	1995-99	E-9966 Curbside	7.188"	F5HZ-3A131B	
		E-9965 Roadside		F5HZ-3A130B	
9000	1973-75	E-4611 Curbside	4.875"	C8TZ-3A130A	w/Air brakes before W40,001.
		E-4610 Roadside		C1TZ-3A131C	
	1975-94	E-4623 Curbside	6.07"	D5TZ-3A130A	w/Air brakes from W40,001; 1980-83 all brakes.
		E-4622 Roadside		D5TZ-3A131A	
	1995-98	E-9966 Curbside	7.188"	F5HZ-3A131B	
		E-9965 Roadside		F5HZ-3A130B	
10000	1987-98	E-4615 Curbside	5.44"	E3HZ-3A130A, E4HZ-3A130A	
		E-4614 Roadside		E3HZ-3A131A, E4HZ-3A131A	
	1992-98	E-9963 Curbside	6.00"	F1HZ-3A130A, F3HZ-3A130B	
		E-9962 Roadside		F1HZ-3A131A, F3HZ-3A131B	

F800, FT800, F880, F8000 (Continued)

Tie Rod Ends (Continued)

Axle Rating Lbs.	Axle Code/Year	Part Number/ Location	Stud Center to Rod End	OEM Reference	Notes
12000	1983-98	E-4615 Curbside	5.44"	D0HZ-3A130A, E3HZ-3A130A, E4HZ-3A130A	w/Air brakes.
		E-4614 Roadside		D0HZ-3A131A, E3HZ-3A131A, E4HZ-3A131A	
	1992-94	E-9963 Curbside	6.00"	F1HZ-3A130A, F3HZ-3A130B	
		E-9962 Roadside		F1HZ-3A131A, F3HZ-3A131B	
	1995-99	E-11788 Curbside	7.75"	F5HZ-3A130AA	
		E-11789 Roadside		F5HZ-3A131AA	
14600	1995-98	E-9963 Curbside	6.00"	F3HZ-3A130B	
		E-9962 Roadside		F3HZ-3A131B	

Drag Links

Axle Rating Lbs.	Axle Code/Year	Part Number	Stud Center to Stud Center	OEM Reference	Notes
5500	1980-83	E-5338	19.25"	E0HZ-3304A	
6000	1984-88	E-5338	19.25"	E0HZ-3304A	
	1989-92	E-6827	20.66"	E8HZ-3304B, F0HZ-3304G	
	1995-98	E-9937	21.23"	F5HZ-3304A	Except low profile option.
7000	1967-68	E-5310	16.64"	C7TZ-3304A	w/Power steering.
	1967-75	E-5310			w/Manual steering before W20,001.
	1976-88	E-5338	19.25"	E0HZ-3304A	
	1989-92	E-6827	20.66"	E8HZ-3304B	
	1995-98	E-9937	21.23"	F5HZ-3304A	Except low profile option.
8000	1992-93	E-9934	19.47"	F2HZ-3304D	Before 5/93.
	1993-98	E-9936	19.43"	F4HZ-3304A	After 5/93.
9000	1980-87	E-5339	19.23"	E0HZ-3304B, E3HZ-3304D	
				F2HZ-3304D	Before 5/93.
	1993-98	E-9936	19.43"	F4HZ-3304A	After 5/93.
10000, 12000	1982-91	E-6836	19.23"	E3HZ-3304A, F0HZ-3304A	

F850, F950

King Pin Kits

Axle Rating Lbs.	Axle Code/Year	Part Number/ Bushing Type	King Pin Size	Type	OEM Reference	Notes
7000	1961-69	E-4438B Bronze	1.234" x 7.438"	B	B7TZ-3111F	
		E-4438N Nylon			C2TZ-3111F	
9000	1961-69	E-4441B Bronze	1.434" x 8.500"	B	D1HZ-3111A	
11000	1962-69	E-4449B Bronze	1.607" x 8.740"	B	D0HZ-3111C	Center point steering.
12000	1961-69	E-4442B Bronze	1.794" x 9.120"	B	D1HZ-3111B	
	1966-69	E-4449B Bronze	1.607" x 8.740"		D0HZ-3111C	Center point steering.

FORD

F850, F950 (Continued)

Tie Rod Ends

Axle Rating Lbs.	Axle Code/Year	Part Number/Location	Stud Center to Rod End	OEM Reference	Notes
7000	1961-69	E-4603 Curbside	3.875"	C1TZ-3A130B	
		E-4602 Roadside		C1TZ-3A131B	
9000	1961-69	E-4611 Curbside	4.875"	C8TZ-3A130A	
		E-4610 Roadside		C1TZ-3A131C	
12000	1961-69	E-4618 Curbside	5.75"	B8TZ-3A131B	
		E-4619 Roadside		B8TZ-3A130B	

F900, F9000, FT900, FT9000

King Pin Kits

Axle Rating Lbs.	Axle Code/Year	Part Number/Bushing Type	King Pin Size	Type	OEM Reference	Notes	
5500	1980-83	E-6199C Composite	1.794" x 10.392"	B	C3TZ-3111A		
6000	1984-90	E-4445B Bronze	1.231" x 8.910"	C	C7TZ-3111A		
		E-4445N Nylon					
7000	1995-99	E-6195B Bronze	1.299" x 7.748"	B	F1HZ-3111A		
		1980-88	E-4445B Bronze	1.231" x 8.910"	C	D7TZ-3111A	w/Hydraulic brakes.
			E-4445N Nylon				
	1989-94	E-4452B Bronze	1.433" x 8.250"	B	D6TZ-3111A	w/Air brakes.	
		E-6195B Bronze	1.299" x 7.748"		E8HZ-3111A	w/Hydraulic brakes.	
	8000	1995-97	E-6195B Bronze			F1HZ-3111A	
1987-92		E-4452B Bronze	1.433" x 8.250"	B	D6TZ-3111A	w/Air brakes.	
9000	1989-99	E-9943B Bronze			E9HZ-3111C	w/Air brakes from 2/91.	
	1980-92	E-4452B Bronze	1.433" x 8.250"	B	D6TZ-3111A		
		E-4457B Bronze	1.607" x 9.080"		D6HZ-3111B	Heavy duty w/air brakes.	
	1983	E-4459C Composite	1.794" x 10.070"		D6HZ-3111C		
1989-99	E-9943B Bronze	1.433" x 8.250"		E9HZ-3111C	w/Air brakes from 2/91.		
10000	1987-90	E-4459B Bronze	1.794" x 10.070"	B	D6HZ-3111A	Except aluminum axle. Bearing 3.26" OD x .94" thick.	
		E-6196B Bronze			E9HZ-3111A	w/Steel axle.	
12000	1982-88	E-4459B Bronze	1.794" x 10.070"	B	D6HZ-3111A	Bearing 3.26" OD x .94" thick.	
	1989-94	E-6196B Bronze			E9HZ-3111A	Screw-in end caps w/steel axle.	
14600	1995	E-9945B Bronze	1.810" x 10.531"	A	F5HZ-3111A		

S.O.S.

Special Order Service

Can't find it?

Trouble sourcing products?

Need assistance?

Let Euclid's Special Order Service (**S.O.S.**) help you find your parts.

Euclid's position as the market leader provides you access to a comprehensive array of truck parts products from the industry's leading manufacturers. Through Euclid, these entire product lines are available to you just by placing a phone call to Euclid's S.O.S.

Department at 866-238-2543 (option 2) in the U.S. or 800-387-3889 in Canada.

F900, F9000, FT900, FT9000 (Continued)

Tie Rod Ends

Axle Rating Lbs.	Axle Code/Year	Part Number/ Location	Stud Center to Rod End	OEM Reference	Notes	
5500	1980-83	E-4605 Curbside	4.438"	C7TZ-3A130D		
		E-4604 Roadside		C7TZ-3A131D		
6000	1984-90	E-4605 Curbside	4.438"	C7TZ-3A130D		
		E-4604 Roadside		C7TZ-3A131D		
	1990	E-4613 Curbside	4.938"	F0HZ-3A130C	Except low profile option.	
		E-4612 Roadside		F0HZ-3A131C		
		E-6864 Curbside	13.25"	F0HZ-3A131D		w/Hydraulic brakes and low profile option.
		E-6863 Roadside		F0HZ-3A130D		
	1990-94	E-4623 Curbside	6.07"	F0HZ-3A131E		
		E-4622 Roadside		F0HZ-3A131F		
1995-99	E-9966 Curbside	7.188"	F5HZ-3A131B			
	E-9965 Roadside		F5HZ-3A130B			
7000	1980-88	E-4623 Curbside	6.07"	D5TZ-3A131A	w/Air brakes.	
		E-4622 Roadside		D5TZ-3A130A		
	1980-90	E-4605 Curbside	4.438"	C7TZ-3A130A	w/Hydraulic brakes except low profile option.	
		E-4604 Roadside		C7TZ-3A131A		
	1990-93	E-6864 Curbside	13.25"	F0HZ-3A131D	w/Hydraulic brakes and low profile option.	
		E-6863 Roadside		F0HZ-3A130D		
	1990-94	E-4623 Curbside	6.07"	F0HZ-3A131E		
		E-4622 Roadside		F0HZ-3A131F		
	1995-99	E-9966 Curbside	7.188"	F5HZ-3A131B		
		E-9965 Roadside		F5HZ-3A130B		
8000	1987-89	E-4623 Curbside	6.07"	D5TZ-3A131A		
		E-4622 Roadside		D5TZ-3A130A		
	1990-98	E-4623 Curbside		F0HZ-3A131B		
		E-4622 Roadside		F0HZ-3A130B		
	1995-99	E-9966 Curbside	7.188"	F5HZ-3A131B		
		E-9965 Roadside		F5HZ-3A130B		
9000	1980-94	E-4623 Curbside	6.07"	D5TZ-3A131A		
		E-4622 Roadside		D5TZ-3A130A		
	1995-98	E-9966 Curbside	7.188"	F5HZ-3A131B		
		E-9965 Roadside		F5HZ-3A130B		
10000	1987-91	E-4615 Curbside	5.44"	E3HZ-3A130A, E4HZ-3A130A		
		E-4614 Roadside		E3HZ-3A131A, E4HZ-3A131A		
	1992-94	E-9962 Roadside	6.00"	F1HZ-3A131A, F3HZ-3A131B		
	1992-98	E-9963 Curbside		F1HZ-3A130A, F3HZ-3A130B		
	12000	1982-91	E-4615 Curbside	5.44"	E3HZ-3A130A, E4HZ-3A130A	
E-4614 Roadside			E3HZ-3A131A, E4HZ-3A131A			
1992-94		E-9963 Curbside	6.00"	F1HZ-3A130A, F3HZ-3A130B		
		E-9962 Roadside		F1HZ-3A131A, F3HZ-3A131B		
1995-99	E-11788 Curbside	7.75"	F5HZ-3A130AA			
	E-11789 Roadside		F5HZ-3A131AA			
14600	1995-98	E-9963 Curbside	6.00"	F3HZ-3A130B		
		E-9962 Roadside		F3HZ-3A131B		

FORD

F900, F9000, FT900, FT9000 (Continued)

Drag Links

Axle Rating Lbs.	Axle Code/Year	Part Number	Stud Center to Stud Center	OEM Reference	Notes
5500	1980-83	E-5338	19.25"	E0HZ-3304A	
6000	1984-88	E-5338	19.25"	E0HZ-3304A	
	1989-91	E-6827	20.66"	E8HZ-3304B, F0HZ-3304G	
	1995-98	E-9937	21.23"	F5HZ-3304A	
7000	1980-88	E-5338	19.25"	E0HZ-3304A	
	1989-91	E-6827	20.66"	E8HZ-3304B	w/Hydraulic brakes.
	1995-98	E-9937	21.23"	F5HZ-3304A	
8000	1992-93	E-9934	19.47"	F2HZ-3304D	Before 5/93.
	1993-98	E-9936	19.43"	F4HZ-3304A	After 5/93.
9000	1980-87	E-5339	19.23"	E0HZ-3304B, E3HZ-3304B	
	1992-93	E-9934	19.47"	F2HZ-3304D	Before 5/93
	1993-98	E-9936	19.43"	F4HZ-3304A	After 5/93.
10000, 12000	1987-91	E-6836	19.23"	E3HZ-3304A, F0HZ-3304A	

HT950, H1000

King Pin Kits

Axle Rating Lbs.	Axle Code/Year	Part Number/ Bushing Type	King Pin Size	Type	OEM Reference	Notes
9000	1964-66	E-4441B Bronze	1.434" x 8.500"	B	D1HZ-3111A	
11000	1964-65	E-4449B Bronze	1.607" x 8.740"	B	D0HZ-3111C	Center point steering.
12000	1964-66	E-4442B Bronze	1.794" x 9.120"	B	D1HZ-3111B	
	1966	E-4449B Bronze	1.607" x 8.740"		D0HZ-3111C	Center point steering.

Tie Rod Ends

Axle Rating Lbs.	Axle Code/Year	Part Number/ Location	Stud Center to Rod End	OEM Reference	Notes
9000	1964-66	E-4611 Curbside	4.875"	C8TZ-3A130A	
		E-4610 Roadside		C1TZ-3A131C	
12000	1964-66	E-4618 Curbside	5.75"	B8TZ-3A131B	
		E-4619 Roadside		B8TZ-3A130B	
15000	1964-66	E-4618 Curbside	5.75"	B8TZ-3A131B	
		E-4619 Roadside		B8TZ-3A130B	



an **ArvinMeritor**™ brand

L800, L8000 (Includes LN, LNT, LS, LT, LTL and LTS)

King Pin Kits

Axle Rating Lbs.	Axle Code/Year	Part Number/ Bushing Type	King Pin Size	Type	OEM Reference	Notes
6000	1967-89	E-4445B Bronze	1.231" x 8.910"	C	C7TZ-3111A	
		E-4445N Nylon				
7000	1963-73	E-4445B Bronze	1.231" x 8.910"	C	C7TZ-3111A	
		E-4445N Nylon				
	1967-88	E-4445B Bronze	1.231" x 8.910"	C	C7TZ-3111A	1980-86 w/hydraulic brakes.
		E-4445N Nylon				
	1973-75	E-4445B Bronze	1.231" x 8.910"	C	C7TZ-3111A	w/Air brakes before W40,001.
		E-4445N Nylon				
	1975-98	E-4452B Bronze	1.433" x 8.250"	B	D6TZ-3111A	w/Air brakes from W40,001
	1987-88	E-4452B Bronze	1.433" x 8.250"		D6TZ-3111A	w/Hydraulic brakes.
1989-98	E-6195B Bronze	1.299" x 7.748"	E8HZ-3111A, F1HZ-3111A			
9000	1962-86	E-4441B Bronze	1.434" x 8.500"	B	D1HZ-3111A	w/Air brakes before W40,001.
	1975-86	E-4457B Bronze	1.607" x 9.080"		D6HZ-3111B	w/Air brakes from W40,001.
	1980-86	E-4459C Composite	1.794" x 10.070"		D6HZ-3111C	w/Air brakes.
	1987-88	E-4452B Bronze	1.433" x 8.250"		D6TZ-3111A	
	1989-98	E-6197B Bronze	1.607" x 9.080"		E9HZ-3111B	w/Screw-in end caps.
	1990-98	E-4457B Bronze	1.607" x 9.080"		D6HZ-3111B	w/Steel axle.
10000	1987-91	E-4459B Bronze	1.794" x 10.070"	B	D6HZ-3111A	w/Steel axle. Bearing 3.26" OD x .94" thick.
	1990-97	E-6196B Bronze			E9HZ-3111A	w/Steel axle.
11000	1987-89	E-4459B Bronze	1.794" x 10.070"	B	D6HZ-3111A	w/Air brakes. Bearing 3.26" OD x .94" thick.
12000	1970-86	E-4442B Bronze	1.794" x 9.120"	B	D1HZ-3111B	w/Hydraulic brakes from 1973, 1970-72 all brakes.
	1973-75	E-4442B Bronze			D1HZ-3111B	w/Air brakes before W40,001.
	1975-89	E-4459B Bronze	1.794" x 10.070"		D6HZ-3111A	w/Air brakes from W40,001. Bearing 3.26" OD x .94" thick.
	1989-98	E-6196B Bronze	1.794" x 10.070"		E9HZ-3111A	w/Steel axle & screw-in end caps.
16000	1970-75	E-4454B Bronze	1.999" x 11.040"	B	D0HZ-3111E	
		E-4454N Nylon				
	1975-98	E-4458B Bronze	1.999" x 11.212"		D5HZ-3111C	
18000	1980-98	E-4458B Bronze	1.999" x 11.212"	B	D5HZ-3111C	
		E-4458C Composite				
20000	1980-98	E-4458B Bronze	1.999" x 11.212"	B	D5HZ-3111C	
		E-4458C Composite				

If you detect any

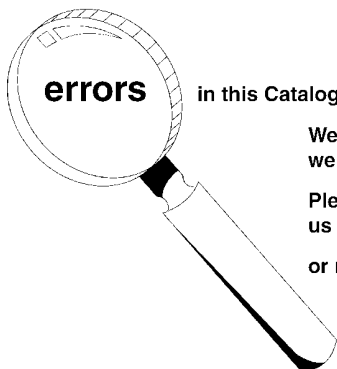

errors

in this Catalog, please let us know.

We want the information to be as accurate as possible;
we appreciate your help in making it so.

Please e-mail any comments/suggestions/corrections to
us at: catalogfeedback@arvinmeritor.com

or mail to:

Euclid Industries, LLC
Attn: Catalog Dept.
7975 Dixie Highway
Florence, KY 41042-2754

FORD

L800, L8000 (Includes LN, LNT, LS, LT, LTL and LTS) (Continued)

Tie Rod Ends

Axle Rating Lbs.	Axle Code/Year	Part Number/ Location	Stud Center to Rod End	OEM Reference	Notes
6000	1967-89	E-4605 Curbside	4.438"	C7TZ-3A130D	
		E-4604 Roadside		C7TZ-3A131D	
7000	1967-73	E-4605 Curbside	4.438"	C7TZ-3A130D	
		E-4604 Roadside		C7TZ-3A131A	
	1973-75	E-4605 Curbside	4.438"	C7TZ-3A130D	w/Air brakes to W40,001.
		E-4604 Roadside		C7TZ-3A131A	
	1973-79	E-4605 Curbside	4.438"	C7TZ-3A130D	w/Hydraulic brakes.
		E-4604 Roadside		C7TZ-3A131A	
	1975-79	E-4623 Curbside	6.07"	D5TZ-3A131A	w/Air brakes from W40,001.
		E-4622 Roadside		D5TZ-3A130A	
	1980-89	E-4623 Curbside	6.07"	D5TZ-3A131A	1987-88 w/hydraulic brakes. 1980-88 w/air brakes.
		E-4622 Roadside		D5TZ-3A130A	
	1980-90	E-4605 Curbside	4.438"	C7TZ-3A130A	1989-90, 1980-86 all w/hydraulic brakes.
		E-4604 Roadside		C7TZ-3A131A	
1990-94	E-4623 Curbside	6.07"	F0HZ-3A131B		
	E-4622 Roadside		F0HZ-3A130B		
1995-97	E-9966 Curbside	7.188"	F5HZ-3A131B		
	E-9965 Roadside		F5HZ-3A130B		
9000	1962-69	E-4611 Curbside	4.875"	C8TZ-3A130A	
		E-4610 Roadside		C1TZ-3A131C	
	1970-72	E-4605 Curbside	4.438"	C7TZ-3A130A	
		E-4604 Roadside		C7TZ-3A130D	
	1973-75	E-4605 Curbside	4.438"	C7TZ-3A131D	w/air brakes to W40,001
		E-4604 Roadside		C7TZ-3A130D	
	1973-86	E-4615 Curbside	5.44"	D0HZ-3A130A	w/Hydraulic brakes.
		E-4614 Roadside		D0HZ-3A131A	
	1975-89	E-4623 Curbside	6.07"	D5TZ-3A131A	1975-86 w/air brakes from W40,001, 1987-89 all.
		E-4622 Roadside		D5TZ-3A130A	
	1990-97	E-4623 Curbside	6.07"	D5TZ-3A131A	w/Steel axle.
		E-4622 Roadside		D5TZ-3A130A	
10000	1987-91	E-4615 Curbside	5.44"	E3HZ-3A130A, E4HZ-3A130A	
		E-4614 Roadside		E3HZ-3A131A, E4HZ-3A131A	
	1992-98	E-9963 Curbside	6.00"	F1HZ-3A130A, F3HZ-3A130B	
		E-9962 Roadside		F1HZ-3A131A, F3HZ-3A131B	
11000	1987-89	E-4615 Curbside	5.44"	E3HZ-3A130A, E4HZ-3A130A	w/Air brakes.
		E-4614 Roadside		E3HZ-3A131A, E4HZ-3A131A	
12000	1970-91	E-4614 Roadside	5.44"	D0HZ-3A131A	w/Air brakes to 1984.
		E-4615 Curbside		D0HZ-3A130A	
	1992-98	E-9963 Curbside	6.00"	F1HZ-3A130A, F3HZ-3A130B	
		E-9962 Roadside		F1HZ-3A131A, F3HZ-3A131B	

L800, L8000 (Includes LN, LNT, LS, LT, LTL and LTS) (Continued)

Tie Rod Ends (Continued)

Axle Rating Lbs.	Axle Code/Year	Part Number/ Location	Stud Center to Rod End	OEM Reference	Notes		
16000	1970-75	E-4617 Curbside	5.75"	D0HZ-3A130B			
		E-4616 Roadside		D0HZ-3A131B			
	1975-90	E-4615 Curbside	5.44"	E3HZ-3A130A, E4HZ-3A130A			
		E-4614 Roadside		E3HZ-3A131A, E4HZ-3A131A			
	1991-98	E-9963 Curbside	6.00"	F1HZ-3A130A, F3HZ-3A130B			
		E-9962 Roadside		F1HZ-3A131A, F3HZ-3A131B			
18000	1980-90	E-4615 Curbside	5.44"	E3HZ-3A130A, E4HZ-3A130A			
		E-4614 Roadside		E3HZ-3A131A, E4HZ-3A131A			
	1991-98	E-9963 Curbside	6.00"	F1HZ-3A130A, F3HZ-3A130B			
		E-9962 Roadside		F1HZ-3A131A, F3HZ-3A131B			
	20000	1980-92	E-4615 Curbside	5.44"		E3HZ-3A130A, E4HZ-3A130A	
			E-4614 Roadside			E3HZ-3A131A, E4HZ-3A131A	
1991-98		E-9963 Curbside	6.00"	F1HZ-3A130A, F3HZ-3A130B			
		E-9962 Roadside		F1HZ-3A131A, F3HZ-3A131B			

S.O.S.

Special Order Service

Can't find it?

Trouble sourcing products?

Need assistance?

*Let Euclid's Special Order Service (**S.O.S.**) help you find your parts.*

Euclid's position as the market leader provides you access to a comprehensive array of truck parts products from the industry's leading manufacturers. Through Euclid, these entire product lines are available to you just by placing a phone call to Euclid's S.O.S. Department at 866-238-2543 (option 2) in the U.S. or 800-387-3889 in Canada.

FORD

L800, L8000 (Includes LN, LNT, LS, LT, LTL and LTS) (Continued)

Drag Links

Axle Rating Lbs.	Axle Code/Year	Part Number	Stud Center to Stud Center	OEM Reference	Notes
6000	1973-75	E-5325	18.03"	D5HZ-3304D, E4HZ-3304B	
7000	1973-91	E-5325	18.03"	E3HZ-3304H, E4HZ-3304B	
9000	1973-91	E-5325	18.03"	E4HZ-3304B	
	1980-87	E-5342	36.31"	E3HZ-3304J	LTS models.
	1987-97	E-6835	36.15"	E8HZ-3304E, E8HZ-3304F	
	1990	E-6839	32.62"	F0HZ-3304E, F0HZ-3304F	
10000	1980-87	E-5342	36.31"	E3HZ-3304J	LTS models.
	1980-91	E-5325	18.03"	E3HZ-3304H, E4HZ-3304B	
	1987-90	E-6835	36.15"	E8HZ-3304E, E8HZ-3304F	
	1990-91	E-6839	32.62"	F0HZ-3304E, F0HZ-3304F	
11000	1987	E-5342	36.31"	E3HZ-3304J	LTS models.
	1987-89	E-5325	18.03"	E3HZ-3304H, E4HZ-3304B	w/Air brakes.
		E-6835	36.15"	E8HZ-3304E, E8HZ-3304F	
12000	1973-91	E-5325	18.03"	E4HZ-3304B	
	1980-87	E-5342	36.31"	E3HZ-3304J	
	1987-97	E-6835	36.15"	E8HZ-3304E, E8HZ-3304F	
	1990-91	E-6839	32.62"	F0HZ-3304E, F0HZ-3304F	
16000	1973-90	E-5325	18.03"	E3HZ-3304H, E4HZ-3304B	
		E-5342	36.31"	E3HZ-3304J	
		E-6835	36.15"	E8HZ-3304E, E8HZ-3304F	
	1991-97	E-9925	17.53"	F1HZ-3304A, F1HZ-3304B	w/LH power steering gear.
		E-9926	32.53"	F1HZ-3304C, F1HZ-3304D	
		E-9927		F1HZ-3304E, F1HZ-3304F	w/RH power steering gear.
	1992-94	E-9933	17.91"	F2HZ-3304C	
18000	1980-87	E-5342	36.31"	E3HZ-3304J	
	1980-91	E-5325	18.03"	E3HZ-3304H, E4HZ-3304B	
	1987-90	E-6835	36.15"	E8HZ-3304E, E8HZ-3304F	
	1991-97	E-9925	17.53"	F1HZ-3304A, F1HZ-3304B	w/LH power steering gear.
		E-9927	32.53"	F1HZ-3304E, F1HZ-3304F	w/RH power steering gear.
	1992-94	E-9933	17.91"	F2HZ-3304C	

L800, L8000 (Includes LN, LNT, LS, LT, LTL and LTS) (Continued)

Drag Links (Continued)

Axle Rating Lbs.	Axle Code/Year	Part Number	Stud Center to Stud Center	OEM Reference	Notes
20000	1980-87	E-5342	36.31"	E3HZ-3304J	
	1980-91	E-5325	18.03"	E3HZ-3304H, E4HZ-3304B	
	1987-90	E-6835	36.15"	E8HZ-3304E, E8HZ-3304F	
	1991-97	E-9925	17.53"	F1HZ-3304A, F1HZ-3304B	w/LH power steering gear.
		E-9927	32.53"	F1HZ-3304E, F1HZ-3304F	w/RH power steering gear.
	1992-94	E-9933	17.91"	F2HZ-3304C	L, LN, LNT, LT models.

L900, L9000 (Includes L, LL, LN, LNT, LS, LT, LTL and LTS)

King Pin Kits

Axle Rating Lbs.	Axle Code/Year	Part Number/ Bushings Type	King Pin Size	Type	OEM Reference	Notes	
7000	1970-86	E-4445B Bronze	1.231" x 8.910"	C	C7TZ-3111A	w/Hydraulic brakes from 1973, 1970-72 all brakes.	
		E-4445N Nylon					
	1973-75	E-4445B Bronze	1.433" x 8.250"	B	D6TZ-3111A	w/Air brakes to W40,001.	
		E-4445N Nylon					
	1975-98	E-4452B Bronze	1.299" x 7.748"		E8HZ-3111A	1980-86 w/air brakes from W40,001, 1987-88 w/hydraulic brakes.	
	1989-90	E-6195B Bronze	1.434" x 8.500"	B	F1HZ-3111A	From 10/90	
1990-98	E-6195B Bronze						
9000	1970-86	E-4441B Bronze	1.607" x 9.080"	B	D1HZ-3111A	w/Hydraulic brakes from 1973, 1970-72 all brakes.	
	1973-75	E-4441B Bronze	1.794" x 10.070"		D6HZ-3111B	w/Air brakes before W40,001.	
		E-4457B Bronze			D6HZ-3111C	w/Air brakes from W40,001.	
	1975-86	E-4459C Composite	1.433" x 8.250"			D6TZ-3111A	w/Air brakes.
	1980-86	E-4459C Composite	1.607" x 9.080"			E9HZ-3111B	w/Air brakes from W40,001.
	1987-88	E-4452B Bronze	1.607" x 9.080"			D6HZ-3111B	w/Screw-in end caps.
	1989	E-6197B Bronze					w/Steel axle.
	1990-98	E-4457B Bronze					
10000	1987-91	E-4459B Bronze	1.794" x 10.070"	B	D6HZ-3111A	w/Steel axle. Bearing 3.26" OD x .94" thick.	
	1990-97	E-6196B Bronze			E9HZ-3111A	w/Steel axle.	
11000	1987-89	E-4459B Bronze	1.794" x 10.070"	B	D6HZ-3111A	w/Steel axle. Bearing 3.26" OD x .94" thick.	
12000	1970-86	E-4442B Bronze	1.794" x 9.120"	B	D1HZ-3111B	w/Hydraulic brakes from 1975, 1970-75 all brakes.	
	1975-94	E-4459B Bronze	1.794" x 10.070"		D6HZ-3111A	w/Air brakes from W40,001. w/Steel axle. Bearing 3.26" OD x .94" thick.	
	1989-98	E-6196B Bronze			E9HZ-3111A	w/Steel axle. Screw-in end caps.	
16000	1970-86	E-4454B Bronze	1.999" x 11.040"	B	D0HZ-3111E	w/Hydraulic brakes from 1973-79, 1970-72 all brakes, 1980-86 all brakes.	
		E-4454N Nylon					
	1973-75	E-4454B Bronze	1.999" x 11.212"		D5HZ-3111C	w/Air brakes to W40,001.	
		E-4454N Nylon					
	1980-98	E-4458B Bronze					w/Air brakes from W40,001.
	E-4458C Composite						
18000	1970-75	E-4454B Bronze	1.999" x 11.040"	B	D0HZ-3111E	Before W40,001.	
		E-4454N Nylon					
	1980-98	E-4458B Bronze	1.999" x 11.212"		D5HZ-3111C	From W40,001.	
		E-4458C Composite					

FORD

L900, L9000 (Includes L, LL, LN, LNT, LS, LT, LTL and LTS) (Continued)

King Pin Kits (Continued)

Axle Rating Lbs.	Axle Code/Year	Part Number/ Bushing Type	King Pin Size	Type	OEM Reference	Notes
20000	1970-75	E-4454B Bronze	1.999" x 11.040"	B	D0HZ-3111E	Before W40,001.
		E-4454N Nylon				
	1980-98	E-4458B Bronze	1.999" x 11.212"		D5HZ-3111C	
		E-4458C Composite				

Tie Rod Ends

Axle Rating Lbs.	Axle Code/Year	Part Number/ Location	Stud Center to Rod End	OEM Reference	Notes		
7000	1970-90	E-4605 Curbside	4.438"	C7TZ-3A130D	1973-86 w/hydraulic brakes. 1989-90 all, 1970-72 all brakes.		
		E-4604 Roadside		C7TZ-3A131D			
	1973-75	E-4605 Curbside		C7TZ-3A130D		w/Air brakes before W40,001.	
		E-4604 Roadside		C7TZ-3A131D			
	1975-88	E-4623 Curbside		6.07"		D5TZ-3A131A	1980-86 w/air brakes from W40,001, 1987-88 w/hydraulic brakes.
		E-4622 Roadside				D5TZ-3A130A	
1995-97	E-9966 Curbside	7.188"	F5HZ-3A131B				
	E-9965 Roadside		F5HZ-3A130B				
9000	1970-86	E-4615 Curbside	5.44"	E4HZ-3A130A	w/Hydraulic brakes from 1973, 1970-72 all brakes.		
		E-4614 Roadside		E4HZ-3A131A			
	1975-97	E-4623 Curbside	6.07"	D5TZ-3A131A			
		E-4622 Roadside		D5TZ-3A130A			
10000	1987-91	E-4615 Curbside	5.44"	E3HZ-3A130A, E4HZ-3A130A			
		E-4614 Roadside		E3HZ-3A131A, E4HZ-3A131A			
	1992-98	E-9963 Curbside	6.00"	F1HZ-3A130A, F3HZ-3A130B			
		E-9962 Roadside		F1HZ-3A131A, F3HZ-3A131B			
11000	1987-89	E-4615 Curbside	5.44"	E3HZ-3A130A, E4HZ-3A130A			
		E-4614 Roadside		E3HZ-3A131A, E4HZ-3A131A			
12000	1970-91	E-4615 Curbside	5.44"	D0HZ-3A130A			
		E-4614 Roadside		D0HZ-3A131A			
	1992-98	E-9963 Curbside	6.00"	F1HZ-3A130A, F3HZ-3A130B			
		E-9962 Roadside		F1HZ-3A131A, F3HZ-3A131B			
16000	1970-79	E-4617 Curbside	5.75"	D0HZ-3A130B	w/Hydraulic brakes from 1973, 1970-72 all brakes.		
		E-4616 Roadside		D0HZ-3A131B			
	1973-75	E-4617 Curbside	5.44"	D0HZ-3A130B	w/Air brakes to W40,001.		
		E-4616 Roadside		D0HZ-3A131B			
	1975-90	E-4615 Curbside	5.44"	D0HZ-3A130A	w/Air brakes from W40,001, 1980-90 all brakes.		
		E-4614 Roadside		D0HZ-3A131A			
	1980-90	E-4615 Curbside	6.00"	E3HZ-3A130A, E4HZ-3A130A			
		E-4614 Roadside		E3HZ-3A131A, E4HZ-3A131A			
	1991-98	E-9963 Curbside	6.00"	F1HZ-3A130A, F3HZ-3A130B			
		E-9962 Roadside		F1HZ-3A131A, F3HZ-3A131B			

L900, L9000 (Includes L, LL, LN, LNT, LS, LT, LTL and LTS) (Continued)

Tie Rod Ends (Continued)

Axle Rating Lbs.	Axle Code/Year	Part Number/ Location	Stud Center to Rod End	OEM Reference	Notes
18000	1970-75	E-4617 Curbside	5.75"	D0HZ-3A130B	To W40,001.
		E-4616 Roadside		D0HZ-3A131B	
	1975-90	E-4615 Curbside	5.44"	D0HZ-3A130A	From W40,001.
		E-4614 Roadside		D0HZ-3A131A	
	1980-90	E-4615 Curbside	5.44"	E3HZ-3A130A, E4HZ-3A130A	
		E-4614 Roadside		E3HZ-3A131A, E4HZ-3A131A	
	1991-98	E-9963 Curbside	6.00"	F1HZ-3A130A, F3HZ-3A130B	
		E-9962 Roadside		F1HZ-3A131A, F3HZ-3A131B	
20000	1970-75	E-4617 Curbside	5.75"	D0HZ-3A130B	To W40,001.
		E-4616 Roadside		D0HZ-3A131B	
	1975-90	E-4615 Curbside	5.44"	D0HZ-3A130A	From W40,001.
		E-4614 Roadside		D0HZ-3A131A	
	1980-90	E-4615 Curbside	5.44"	E3HZ-3A130A, E4HZ-3A130A	
		E-4614 Roadside		E3HZ-3A131A, E4HZ-3A131A	
	1991-98	E-9963 Curbside	6.00"	F1HZ-3A130A, F3HZ-3A130B	
		E-9962 Roadside		F1HZ-3A131A, F3HZ-3A131B	

S.O.S.

Special Order Service

Can't find it?

Trouble sourcing products?

Need assistance?

Let Euclid's Special Order Service (S.O.S.) help you find your parts.

Euclid's position as the market leader provides you access to a comprehensive array of truck parts products from the industry's leading manufacturers. Through Euclid, these entire product lines are available to you just by placing a phone call to Euclid's S.O.S. Department at 866-238-2543 (option 2) in the U.S. or 800-387-3889 in Canada.

FORD

L900, L9000 (Includes L, LL, LN, LNT, LS, LT, LTL and LTS) (Continued)

Drag Links

Axle Rating Lbs.	Axle Code/Year	Part Number	Stud Center to Stud Center	OEM Reference	Notes
7000	1973-91	E-5325	18.03"	D5HZ-3304D	
9000	1973-91	E-5325	18.03"	D5HZ-3304D	
		E-5342	36.31"	D0HZ-3304B	
	1987-97	E-6835	36.15"	E8HZ-3304E, E8HZ-3304F	
	1990	E-6839	32.62"	F0HZ-3304E, F0HZ-3304F	
10000	1980-91	E-5325	18.03"	E3HZ-3304H, E4HZ-3304B	
	1987	E-5342	36.31"	E3HZ-3304J	LTS models.
	1987-90	E-6835	36.15"	E8HZ-3304E, E8HZ-3304F	1990 LS-LTS models w/unitized tractor application.
	1990-91	E-6839	32.62"	F0HZ-3304E, F0HZ-3304F	
11000	1987-89	E-5325	18.03"	E3HZ-3304H, E4HZ-3304B	
		E-6835	36.15"	E8HZ-3304E	
12000	1973-87	E-5342	36.31"	D0HZ-3304B	
	1973-91	E-5325	18.03"	D5HZ-3304B, E4HZ-3304B	
	1987-89	E-6835	36.15"	E8HZ-3304E, E8HZ-3304F	
	1990	E-6839	32.62"	F0HZ-3304E, F0HZ-3304F	
	1990-91	E-6839			Except 5400/12000 lb. front spring capacity (taper leaf).
16000	1973-87	E-5342	36.31"	D0HZ-3304B	
	1980-90	E-5325	18.03"	E3HZ-3304H, E4HZ-3304B	
	1987-90	E-6835	36.15"	E8HZ-3304E, E8HZ-3304F	
	1991-97	E-9925	17.53"	F1HZ-3304A, F1HZ-3304B	w/LH power steering gear.
		E-9926	32.53"	F1HZ-3304C, F1HZ-3304D	
		E-9927		F1HZ-3304E, F1HZ-3304F	w/RH power steering gear.
1992-94	E-9933	17.91"	F2HZ-3304C	L, LN, LNT, LT models.	
18000	1973-87	E-5342	36.31"	D0HZ-3304B	
	1980-90	E-5325	18.03"	E3HZ-3304H, E4HZ-3304B	
	1987-90	E-6835	36.15"	E8HZ-3304E, E8HZ-3304F	
	1991-97	E-9925	17.53"	F1HZ-3304A, F1HZ-3304B	w/LH power steering gear.
		E-9927	32.53"	F1HZ-3304E, F1HZ-3304F	w/RH power steering gear.
	1992-94	E-9933	17.91"	F2HZ-3304C	L, LN, LNT, LT models.



an ArvinMeritor™ brand

L900, L9000 (Includes L, LL, LN, LNT, LS, LT, LTL and LTS) (Continued)

Drag Links (Continued)

Axle Rating Lbs.	Axle Code/Year	Part Number	Stud Center to Stud Center	OEM Reference	Notes
20000	1973-87	E-5342	36.31"	D0HZ-3304B	
	1980-90	E-5325	18.03"	E3HZ-3304H, E4HZ-3304B	
	1987-90	E-6835	36.15"	E8HZ-3304E, E8HZ-3304F	
	1991-97	E-9925	17.53"	F1HZ-3304A, F1HZ-3304B	w/LH power steering gear.
		E-9927	32.53"	F1HZ-3304E, F1HZ-3304F	w/RH power steering gear.
1992-94	E-9933	17.91"	F2HZ-3304C	L, LN, LNT, LT models.	

LLA900, LLS900, LTLA900, LTLS900

King Pin Kits

Axle Rating Lbs.	Axle Code/Year	Part Number/ Bushing Type	King Pin Size	Type	OEM Reference	Notes
14600, 16000, 18000	1991-98	E-4458B Bronze	1.999" x 11.212"	B	D5HZ-3111C	

Tie Rod Ends

Axle Rating Lbs.	Axle Code/Year	Part Number/ Location	Stud Center to Rod End	OEM Reference	Notes
14600, 16000, 18000	1991-98	E-9963 Curbside	6.00"	F1HZ-3A130A, F3HZ-3A130B	
		E-9962 Roadside		F1HZ-3A131A, F3HZ-3A131B	

Drag Links

Axle Rating Lbs.	Axle Code/Year	Part Number	Stud Center to Stud Center	OEM Reference	Notes
14600, 16000, 18000	1992-97	E-9929	22.61"	F1HZ-3304J	Used with F1HT-3304VA.

LN500

King Pin Kits

Axle Rating Lbs.	Axle Code/Year	Part Number/ Bushing Type	King Pin Size	Type	OEM Reference	Notes
5000	1967-72	E-4440B Bronze	1.231" x 7.860"	C	C3TZ-3111A	

Tie Rod Ends

Axle Rating Lbs.	Axle Code/Year	Part Number/ Location	Stud Center to Rod End	OEM Reference	Notes
5000	1967-72	E-4605 Curbside	4.438"	C7TZ-3A130D	
		E-4604 Roadside		C7TZ-3A131D	

Drag Links

Axle Rating Lbs.	Axle Code/Year	Part Number	Stud Center to Stud Center	OEM Reference	Notes
5000	1971	E-5310	16.64"	C7TZ-3304A	

FORD

LN600

King Pin Kits

Axle Rating Lbs.	Axle Code/Year	Part Number/ Bushing Type	King Pin Size	Type	OEM Reference	Notes
5000	1967-73	E-4440B Bronze	1.231" x 7.860"	C	C3TZ-3111A	
5500	1967-89	E-4440B Bronze	1.231" x 7.860"	C	C3TZ-3111A	
6000	1967-95	E-4445B Bronze	1.231" x 8.910"	C	C7TZ-3111A	
7000	1967-75	E-4445N Nylon	1.231" x 8.910"	C	C7TZ-3111A	Before W40,001.
		E-4445B Bronze				.01 oversize. Before W40,001.
	1975-95	E-4452B Bronze	1.433" x 8.250"	B	D6TZ-3111A	From W40,001. w/Air brakes 1980-83.
	1980-95	E-4445B Bronze	1.231" x 8.910"	C	C7TZ-3111A	w/Hydraulic brakes.
9000	1967-95	E-4445N Nylon	1.433" x 8.250"	B	D6TZ-3111A	From W40,001.
	1973-95	E-4441B Bronze	1.434" x 8.500"			D1HZ-3111A

Tie Rod Ends

Axle Rating Lbs.	Axle Code/Year	Part Number/ Location	Stud Center to Rod End	OEM Reference	Notes
5000	1967-73	E-4605 Curbside	4.438"	C7TZ-3A130D	
		E-4604 Roadside		C7TZ-3A131D	
5500	1967-89	E-4605 Curbside	4.438"	C7TZ-3A130D	
		E-4604 Roadside		C7TZ-3A131D	
6000	1967-95	E-4605 Curbside	4.438"	C7TZ-3A130D	
		E-4604 Roadside		C7TZ-3A131D	
7000	1973-75	E-4605 Curbside	4.438"	C7TZ-3A130D	w/Air brakes before W40,001.
		E-4604 Roadside		C7TZ-3A131D	
	1973-95	E-4605 Curbside	4.438"	C7TZ-3A130D	w/Hydraulic brakes.
		E-4604 Roadside		C7TZ-3A131D	
1975-95	E-4623 Curbside	6.07"	D5TZ-3A131A	w/Air brakes from W40,001.	
	E-4622 Roadside		D5TZ-3A130A		
9000	1973-75	E-4611 Curbside	4.875"	C8TZ-3A130A	w/Air brakes before W40,001.
		E-4610 Roadside		C1TZ-3A131C	
	1975-95	E-4623 Curbside	6.07"	D5TZ-3A131A	w/Air brakes from W40,001.
		E-4622 Roadside		D5TZ-3A130A	

LN700, LN750

King Pin Kits

Axle Rating Lbs.	Axle Code/Year	Part Number/ Bushing Type	King Pin Size	Type	OEM Reference	Notes
5000	1970-73	E-4440B Bronze	1.231" x 7.860"	C	C3TZ-3111A	
5500	1970-89	E-4440B Bronze	1.231" x 7.860"	C	C3TZ-3111A	
6000	1970-97	E-4445B Bronze	1.231" x 8.910"	C	C7TZ-3111A	
		E-4445N Nylon				
7000	1970-86	E-4445B Bronze	1.231" x 8.910"	C	C7TZ-3111A	w/Hydraulic brakes from 1973.
		E-4445N Nylon				
	1971-97	E-4445B Bronze	1.231" x 8.910"	C	C7TZ-3111A	w/Air brakes before W40,001.
		E-4445N Nylon				
1975-97	E-4452B Bronze	1.433" x 8.250"	B	D6TZ-3111A	w/Air brakes from W40,001.	
9000	1970-83	E-4441B Bronze	1.434" x 8.500"	B	D1HZ-3111A	w/Hydraulic brakes from 1973.
	1973-97	E-4441B Bronze	1.434" x 8.500"			w/Air brakes before W40,001.
	1975-97	E-4452B Bronze	1.433" x 8.250"		D6TZ-3111A	w/Air brakes from W40,001; 1984-89 all brakes.

LN700, LN750 (Continued)

Tie Rod Ends

Axle Rating Lbs.	Axle Code/Year	Part Number/ Location	Stud Center to Rod End	OEM Reference	Notes	
5000	1970-73	E-4605 Curbside	4.438"	C7TZ-3A130D		
		E-4604 Roadside		C7TZ-3A131D		
5500	1970-89	E-4605 Curbside	4.438"	C7TZ-3A130D		
		E-4604 Roadside		C7TZ-3A131D		
6000	1970-97	E-4605 Curbside	4.438"	C7TZ-3A130D		
		E-4604 Roadside		C7TZ-3A131D		
7000	1970-97	E-4605 Curbside	4.438"	C7TZ-3A130D	w/Hydraulic brakes from 1973.	
		E-4604 Roadside		C7TZ-3A131D		
	1973-75	E-4605 Curbside		C7TZ-3A130D	w/Air brakes before W40,001.	
		E-4604 Roadside		C7TZ-3A131D		
	1975-97	E-4623 Curbside		6.07"	D5TZ-3A131A	w/Air brakes from W40,001.
		E-4622 Roadside			D5TZ-3A130A	
9000	1970-89	E-4611 Curbside	4.875"	C8TZ-3A130C	w/Manual steering. w/Hydraulic brakes.	
		E-4610 Roadside		C1TZ-3A131C		
	1973-75	E-4611 Curbside		C8TZ-3A130C	w/Manual steering. w/Air brakes before W40,001.	
		E-4610 Roadside		C1TZ-3A131C		
	1975-97	E-4623 Curbside		6.07"	D5TZ-3A131A	w/Air brakes from W40,001.
		E-4622 Roadside			D5TZ-3A130A	

LNT880, LT880

King Pin Kits

Axle Rating Lbs.	Axle Code/Year	Part Number/ Bushing Type	King Pin Size	Type	OEM Reference	Notes
7000	1972-77	E-4445B Bronze	1.231" x 8.910"	C	C7TZ-3111A	
		E-4445N Nylon				
9000	1972-77	E-4441B Bronze	1.434" x 8.500"	B	D1HZ-3111A	
12000	1972-77	E-4442B Bronze	1.794" x 9.120"	B	D1HZ-3111B	

Tie Rod Ends

Axle Rating Lbs.	Axle Code/Year	Part Number/ Location	Stud Center to Rod End	OEM Reference	Notes
7000, 9000	1972-77	E-4605 Curbside	4.438"	C7TZ-3A130D	
		E-4604 Roadside		C7TZ-3A131D	
12000	1972-77	E-4615 Curbside	5.44"	D0HZ-3A130A	
		E-4614 Roadside		D0HZ-3A131A	

Louisville (New Design) L and LT 85/95

King Pin Kits

Axle Rating Lbs.	Axle Code/Year	Part Number/ Bushing Type	King Pin Size	Type	OEM Reference	Notes
9000	1996-97	E-6197B Bronze	1.607" x 9.080"	B	E9HZ-3111B	
18000, 20000	1996-97	E-4458B Bronze	1.999" x 11.212"	B	D5HZ-3111C	

Tie Rod Ends

Axle Rating Lbs.	Axle Code/Year	Part Number/ Location	Stud Center to Rod End	OEM Reference	Notes
9000	1996-98	E-9966 Curbside	7.188"	F4HZ-3A130AA	
		E-9965 Roadside		F4HZ-3A131AA	
10000, 12000, 13000, 18000, 20000	1996-97	E-11788 Curbside	7.75"	F6HZ-3A130AA	
		E-11789 Roadside		F6HZ-3A131AA	

FORD

Louisville (New Design) L and LT 85/95 (Continued)

Drag Links

Axle Rating Lbs.	Axle Code/Year	Part Number	Stud Center to Stud Center	OEM Reference	Notes
13000	1996-97	E-11790	19.06"	F6HZ-3304FB	

M400 Motor Home Chassis

King Pin Kits

Axle Rating Lbs.	Axle Code/Year	Part Number/ Bushing Type	King Pin Size	Type	OEM Reference	Notes
	1973-76	E-4440B Bronze	1.231" x 7.860"	C	C3TZ-3111A	

Tie Rod Ends

Axle Rating Lbs.	Axle Code/Year	Part Number/ Location	Stud Center to Rod End	OEM Reference	Notes
	1973-76	E-4605 Curbside	4.438"	C3TZ-3A130D	
		E-4604 Roadside		C3TZ-3A131D	

N500, N600, N6000, N8000, N850, NT850, N950, NT950, N1000, N1100

King Pin Kits

Axle Rating Lbs.	Axle Code/Year	Part Number/ Bushing Type	King Pin Size	Type	OEM Reference	Notes	
5000, 5500	1963-69	E-4440B Bronze	1.231" x 7.860"	C	C3TZ-3111A		
6000	1967-69	E-4445B Bronze	1.231" x 8.910"	C	C7TZ-3111A	From C70,001.	
		E-4445N Nylon					
7000	1963-69	E-4438B Bronze	1.234" x 7.438"	B	B7TZ-3111F		
		E-4438N Nylon			C2TZ-3111F		
	1967-69	E-4445B Bronze	1.231" x 8.910"	C	C7TZ-3111A		
		E-4445N Nylon					
9000	1962-69	E-4441B Bronze	1.434" x 8.500"	B	D1HZ-3111A		
11000	1962-69	E-4449B Bronze	1.607" x 8.740"	B	D0HZ-3111C	Center point steering.	
12000	1962-69	E-4449B Bronze	1.607" x 8.740"	B	D0HZ-3111C		
		E-4442B Bronze			1.794" x 9.120"		D1HZ-3111B
	1968-69	E-4454B Bronze	1.999" x 11.040"		D0HZ-3111E		Center point steering.
		E-4454N Nylon					

Tie Rod Ends

Axle Rating Lbs.	Axle Code/Year	Part Number/ Location	Stud Center to Rod End	OEM Reference	Notes	
5000, 5500	1963-66	E-4635 Curbside	3.50"	C1TZ-3A130A	w/Manual steering.	
		E-4634 Roadside		C1TZ-3A131A		
	1967-69	E-4605 Curbside	4.438"	C7TZ-3A130D		
		E-4604 Roadside		C7TZ-3A131D		
6000	1967-69	E-4605 Curbside	4.438"	C7TZ-3A130D		
		E-4604 Roadside		C7TZ-3A131D		
	7000	1963-69	E-4603 Curbside	3.875"		C1TZ-3A130B
			E-4602 Roadside			C1TZ-3A131B
1967-69	E-4605 Curbside	4.438"	C7TZ-3A130D			
	E-4604 Roadside		C7TZ-3A131D			
9000	1962-69	E-4611 Curbside	4.875"	C1TZ-3A130C	Except 1968-69 power steering.	
		E-4610 Roadside		C1TZ-3A131C		
12000	1962-69	E-4618 Curbside	5.75"	B8TZ-3A131B		
		E-4619 Roadside		B8TZ-3A130B		
15000	1964-69	E-4618 Curbside	5.75"	B8TZ-3A131B		
		E-4619 Roadside		B8TZ-3A130B		

FORD

P400, P500, P600

King Pin Kits

Axle Rating Lbs.	Axle Code/Year	Part Number/ Bushing Type	King Pin Size	Type	OEM Reference	Notes
4700	1963-79	E-4440B Bronze	1.231" x 7.860"	C	C3TZ-3111A	
5000	1978-79	E-4440B Bronze	1.231" x 7.860"	C	C3TZ-3111A	

Tie Rod Ends

Axle Rating Lbs.	Axle Code/Year	Part Number/ Location	Stud Center to Rod End	OEM Reference	Notes
3800	1957-78	E-4635 Curbside	3.50"	C1TZ-3A130A	
		E-4634 Roadside		C1TZ-3A131A	
4700	1961-90	E-4635 Curbside	3.50"	C1TZ-3A130A	
		E-4634 Roadside		C1TZ-3A131A	
5000	1978-79	E-4605 Curbside	4.438"	C7TZ-3A130D	
		E-4604 Roadside		C7TZ-3A131D	

T800, T850, T950

King Pin Kits

Axle Rating Lbs.	Axle Code/Year	Part Number/ Bushing Type	King Pin Size	Type	OEM Reference	Notes
7000	1967-69	E-4438B Bronze	1.234" x 7.438"	B	B7TZ-3111F	
		E-4438N Nylon			C2TZ-3111F	
9000	1961-69	E-4441B Bronze	1.434" x 8.500"	B	D1HZ-3111A	
11000	1962-69	E-4449B Bronze	1.607" x 8.740"	B	D0HZ-3111C	Center point steering.
12000	1962-69	E-4442B Bronze	1.794" x 9.120"	B	D1HZ-3111B	
	1966-69	E-4449B Bronze	1.607" x 8.740"		D0HZ-3111C	
18000	1964-69	E-4454B Bronze	1.999" x 11.040"	B	D0HZ-3111E	
		E-4454N Nylon				

Tie Rod Ends

Axle Rating Lbs.	Axle Code/Year	Part Number/ Location	Stud Center to Rod End	OEM Reference	Notes
7000	1967-69	E-4603 Curbside	3.875"	C1TZ-3A130B	
		E-4602 Roadside		C1TZ-3A131B	
9000	1961-69	E-4611 Curbside	4.875"	C8TZ-3A130A	
		E-4610 Roadside		C1TZ-3A131C	
12000, 15000	1962-69	E-4618 Curbside	5.75"	B8TZ-3A131B	
		E-4619 Roadside		B8TZ-3A130B	
18000	1964-69	E-4618 Curbside	5.75"	B8TZ-3A131B	
		E-4619 Roadside		B8TZ-3A130B	

W900, WT900, W9000, WT9000, W1000, WT10000

King Pin Kits

Axle Rating Lbs.	Axle Code/Year	Part Number/ Bushing Type	King Pin Size	Type	OEM Reference	Notes
12000	1966-75	E-4449B Bronze	1.607" x 8.740"	B	D0HZ-3111C	Center point steering.
		E-4442B Bronze	1.794" x 9.120"		D1HZ-3111B	Before W40,001.
	1975-77	E-4459B Bronze	1.794" x 10.070"		D6HZ-3111A	From W40,001.

FORD

W900, WT900, W9000, WT9000, W1000, WT10000 (Continued)

Tie Rod Ends

Axle Rating Lbs.	Axle Code/Year	Part Number/ Location	Stud Center to Rod End	OEM Reference	Notes
12000	1966-70	E-4618 Curbside	5.75"	B8TZ-3A131B	Before W40,001.
		E-4619 Roadside		B8TZ-3A130B	
	1970-75	E-4617 Curbside		D0HZ-3A130C	
		E-4616 Roadside		D0HZ-3A131C	
15000	1966-70	E-4618 Curbside	5.75"	B8TZ-3A131B	
		E-4619 Roadside		B8TZ-3A130B	
	1973-74	E-4617 Curbside		D0HZ-3A130C	
		E-4616 Roadside		D0HZ-3A131C	

FLEET VEHICLE MAINTENANCE COMPONENTS

The Euclid Brand offers "All-Makes" Aftermarket Maintenance Components for these Vehicle Systems:

BRAKE PRODUCTS

Euclid New Lined Brake Shoes
 Euclid Relined Brake Shoes
 Euclid Friction Materials
 Camshafts
 Air Drum Brake Components & Kits
 Air Disc Pads & Components
 Hydraulic Disc Pads
 Hydraulic Drum & Disc Brake Components
 Automatic & Manual Slack Adjusters
 Brake & Camshaft Repair Kits

WHEEL END PRODUCTS

Cast Brake Drums
 X-30 Steelite Brake Drums
 Hubs & Spoke Wheels
 Rotors - Hydraulic Disc
 Wheel Attaching Components
 Seals & Bearings

DRIVELINE PRODUCTS

Universal Joints - US only
 Center Bearings - US only
 Miscellaneous Hardware - US only

AIR SYSTEM PRODUCTS

Air Dryers & Cartridges
 Air Valves - New & Reman
 Reman Air Compressors
 Air Brake Hose & Fittings

TRAILER PRODUCTS

Axle Tubes
 "Dressed" Axles

FRONT AXLE PRODUCTS

King Pin Kits
 Tie Rod & Drag Link Ends
 Drag Links

SUSPENSION PRODUCTS

Air Springs
 Equalizers, Hangers, Beams
 Bushings & Hardware
 Speciality Polyurethane Components
 Torque Rods
 U-Bolts
Gabriel® Shock Absorbers

AIR CONDITIONING & HEATING PRODUCTS

Compressors
 Clutches
 Blower Motors
 Receiver Driers
 Valves, Switches
 Condensor, Evaporator, Heater Cores
 Tools
 Chemicals, Lubricants
 Refrigerants

ELECTRICAL & WATER PUMPS

Alternators
 Starters
 Electrical Parts & Accessories
 Water Pumps
 Fan Clutches Rebuilt Kits

OTHER PRODUCTS

Ankra Cargo Restraint Systems

INDEX

Model	Page No.
All Models (Conventional and COE)	11-60

Model	Page No.

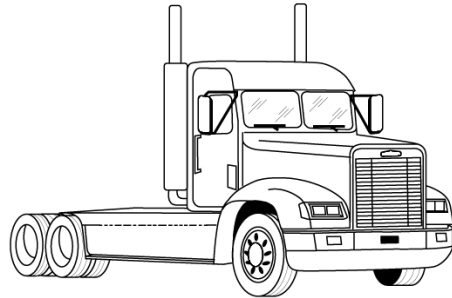

CONVENTIONAL(FLD)

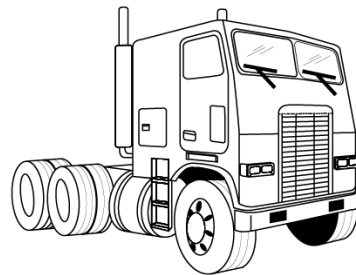

COE (FLP, FLT)

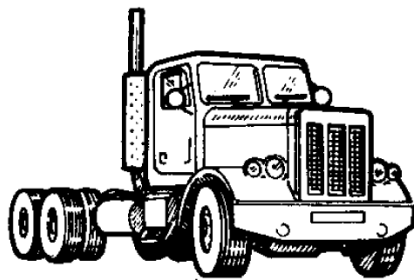

CONVENTIONAL (FLC)

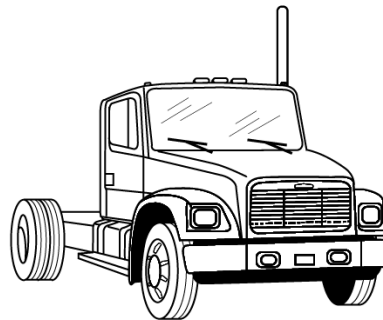

**BUSINESS CLASS
(FL/MB SERIES)**

FREIGHTLINER

All Models (Conventional and COE)

King Pin Kits

Axle Rating Lbs.	Axle Code/Year	Part Number/ Bushings Type	King Pin Size	Type	OEM Reference	Notes
12000	(FE900)	E-4434B Bronze	9.750"	D	KIT 144	Tapered pin.
		E-4434N Bronze, Nylon			KIT 123	
	(FE970)	E-4449B Bronze	1.607" x 8.740"	B	KIT 157	
	(FF901)	E-4442B Bronze	1.794" x 9.120"		KIT 172	
	(FF921)	E-4450B Bronze	1.794" x 10.410"		KIT 193	
	(FF931)	E-4468B Bronze	1.794" x 10.392"		KIT 195	
		E-4694C Composite			KIT 1307	
	(FF943)	E-4468B Bronze	KIT 195			
		E-4694C Composite	KIT 1307			
	(FF961)	E-6199C Composite	KIT 1315			
		(FF971)	E-4595B Bronze		1.607" x 9.375"	
	EFA12F4	E-4696B Bronze	1.625" x 9.195"		A	
		E-4696C Composite				
	14600	(FG941 & FG943)	E-4695C Composite	1.794" x 10.392"	B	KIT 1309
E-6868B Bronze			KIT 1310			
16000	(FH901)	E-4454B Bronze	1.999" x 11.040"	B	KIT 170	
		E-4454N Nylon			KIT 168	
	(FL931)	E-4458B Bronze	1.999" x 11.212"		KIT 198	
		E-4458C Composite			KIT 1312	
18000	(FL901)	E-4454B Bronze	1.999" x 11.040"	B	KIT 170	
		E-4454N Nylon			KIT 168	
20000	(FL941)	E-4458B Bronze	1.999" x 11.212"	B	KIT 198	
		E-4458C Composite			KIT 1312	
24000	(FL931)	E-6199C Composite	1.794" x 10.392"	B	KIT 1315	Dual steer axle.

If you detect any

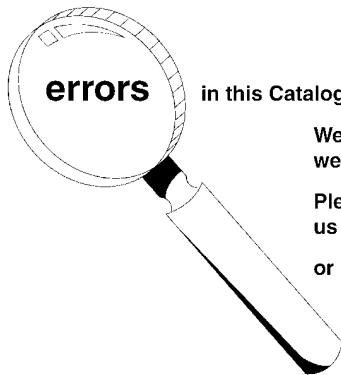

errors

in this Catalog, please let us know.

We want the information to be as accurate as possible;
we appreciate your help in making it so.

Please e-mail any comments/suggestions/corrections to
us at: catalogfeedback@arvinmeritor.com

or mail to: **Euclid Industries, LLC**
Attn: Catalog Dept.
7975 Dixie Highway
Florence, KY 41042-2754

All Models (Conventional and COE) (Continued)

Tie Rod Ends

Axle Rating Lbs.	Axle Code/Year	Part Number/ Location	Stud Center to Rod End	OEM Reference	Notes
12000	(FE900)	E-4611 Curbside	4.875"	A3144R226	
		E-4610 Roadside		A3144Q225	
	(FE970)	E-4611 Curbside	10.50"	A3144R226	
		E-4610 Roadside		A3144Q225	
		E-6848 Curbside		A3144N534	
		E-6847 Roadside		A3144M533	
	(FF901)	E-4611 Curbside	4.875"	A3144R226	
		E-4610 Roadside		A3144Q225	
		E-4618 Curbside	5.75"	A3144D238	
		E-4619 Roadside		A3144C237	
		E-4617 Curbside	10.50"	A3144J296	
		E-4616 Roadside		A3144K297	
	(FF921)	E-4615 Curbside	5.44"	A3144D524	
		E-4614 Roadside		A3144E525	
	(FF931)	E-4615 Curbside	5.44"	A3144D524	
		E-4614 Roadside		A3144E525	
	(FF943)	E-4615 Curbside	5.44"	A3144D524	
		E-4614 Roadside		A3144E525	
	(FF961)	E-4615 Curbside	5.44"	A3144D524	
		E-4614 Roadside		A3144E525	
(FF971)	E-6848 Curbside	10.50"	A3144N534		
	E-6847 Roadside		A3144M533		
E1200I	E-10137 Curbside	6.00"	817019		
	E-10138 Roadside		817018		
EFA12F4	E-4615 Curbside	5.44"	1006149		
	E-4614 Roadside		1006148		
	E-8758 Curbside	8.125"	1009010		
	E-8757 Roadside		1009009		
14600	(FG941 & FG943)	E-4615 Curbside	5.44"	A3144D524	
E-4614 Roadside		5.44"	A3144E525		
16000	(FH901)	E-4617 Curbside	5.75"	A3144J296	
		E-4616 Roadside	5.75"	A3144K297	
	(FL931)	E-4629 Curbside	7.37"	A3144F448	
		E-4628 Roadside	7.37"	A3144G449	
18000	(FL901)	E-4617 Curbside	5.75"	A3144J296	
		E-4616 Roadside	5.75"	A3144K297	
20000	(FG903)	E-4617 Curbside	5.75"	A3144J296	
		E-4616 Roadside		A3144K297	
	(FL941)	E-4617 Curbside	7.37"	A3144J296	
		E-4616 Roadside		A3144K297	
		E-4629 Curbside	7.37"	A3144F448	
		E-4628 Roadside		A3144G449	
		E-6856 Curbside	12.688"	A3144D550	
		E-6857 Roadside		A3144C549	
24000	(FL931)	E-4615 Curbside	5.44"	A3144D524	
		E-4614 Roadside		A3144E525	



an **ArvinMeritor**™ brand

FREIGHTLINER

All Models (Conventional and COE) (Continued)

Drag Links

Axle Rating Lbs.	Axle Code/Year	Part Number	Stud Center to Stud Center	OEM Reference	Notes
12000, 16000, 18000	(All)	E-4616	5.75" Stud center to rod end	A3144K297	Drag link end - LH thread.
		E-4617		L28SV5004D1	Drag link end - RH thread.
		E-5391		L28SV5019A1	Drag link end - LH thread.
12000	(FF940 & FF943)	E-4617	5.75" Stud center to rod end	681-460-15-05	Drag link end - RH thread.
16000, 20000	(FL931)	E-9897	28.87"	14-12098-001	w/Sheppard M100 steering.

S.O.S.

Special Order Service

Can't find it?

Trouble sourcing products?

Need assistance?

*Let Euclid's Special Order Service (**S.O.S.**) help you find your parts.*

Euclid's position as the market leader provides you access to a comprehensive array of truck parts products from the industry's leading manufacturers. Through Euclid, these entire product lines are available to you just by placing a phone call to Euclid's S.O.S. Department at 866-238-2543 (option 2) in the U.S. or 800-387-3889 in Canada.

INDEX

Model	Page No.	Model	Page No.
3500 (1 Ton) 2WD	11-64	M60, M6000	11-86
A60	11-64	M65, M6500	11-87
A80, N80, Q80, V80	11-64	M90, M9500	11-88
B60, B6P, B6000	11-64	N50	11-89
B70, C7500, Kodiak, TopKick	11-66	N60, Y60	11-89
Bison, General, N9E, N9F	11-67	P1500 (1/2 Ton) 2WD	11-89
Bruin, Brigadier, J8C, J9C	11-68	P2500 (3/4 Ton) 2WD	11-90
C40	11-69	P40	11-90
C50, C5D, C5000, E5500, H5500, C4500, E4500	11-70	P4500	11-90
C5500, Kodiak, TopKick	11-70	P50	11-90
C60, C6D, C6000, C6H042, Kodiak, TopKick	11-71	P60	11-91
C65, E6500	11-73	P6000	11-92
C6500, Kodiak, TopKick	11-74	Q60, V60, X60	11-92
C70, C7D, C7H042, C7H064, Kodiak, TopKick	11-74	R8500	11-93
C8500, Kodiak, TopKick	11-76	S50, Q50	11-93
C9500	11-76	S60, S6000	11-94
D50	11-76	S70, S7T, S7500	11-94
D60	11-77	T50, T5500	11-95
D90, D9500	11-77	T60, T6000	11-95
F90	11-78	T65, T6500	11-96
F9500	11-79	T70, T7500	11-97
H70, H7500	11-79	T80, T8500	11-98
H80, H8500	11-80	T90, T9500	11-99
H90, H9500	11-81	Titan, Astro, D9K, D9L	11-100
J70, J7500	11-81	W60, W6N	11-100
J80	11-82	W70	11-101
J8500	11-83	W70, W7N, W7500	11-102
J90, J9500	11-84	W80, W8500	11-103
L50	11-85	W90, W9500	11-103
L60, C80, E80, L80, M80, U80	11-85		
M50	11-86		



KODIAK/TOPKICK



BRUIN
(Conventional
70-80 Series)



BISON
(Conventional
80-90 Series)



"S" SERIES
(School Bus)



"T" SERIES
(Steel Tilt Cab)



TITAN
(Aluminum Tilt Cab)

GMC/CHEVROLET

3500 (1 Ton) 2WD

King Pin Kits

Axle Rating Lbs.	Axle Code/Year	Part Number/ Bushing Type	King Pin Size	Type	OEM Reference	Notes
	(F050) 1965-66	E-4444B Bronze	1.109" x 6.343"	A	3927942	
		E-4444N Nylon				

Tie Rod Ends

Axle Rating Lbs.	Axle Code/Year	Part Number/ Location	Stud Center to Rod End	OEM Reference	Notes
	(F040) 1965-66	E-4625 Curbside	6.50"	3864354	
		E-4624 Roadside		3864353	
	(F050) 1965-66	E-4621 Curbside	5.84"	3864348	
		E-4620 Roadside		3864347	

A60

King Pin Kits

Axle Rating Lbs.	Axle Code/Year	Part Number/ Bushing Type	King Pin Size	Type	OEM Reference	Notes
7000	1965	E-4443B Bronze	1.249" x 7.888"	A	3927943	
		E-4443N Nylon				
9000	1965	E-4435B Bronze	8.750"	D	2321013	Tapered pin.
		E-4435N Bronze, Nylon			8885021	
11000	1965	E-4434B Bronze	9.750"	D	2264897	Tapered pin.
		E-4434N Bronze, Nylon				

Tie Rod Ends

Axle Rating Lbs.	Axle Code/Year	Part Number/ Location	Stud Center to Rod End	OEM Reference	Notes
7000	1965	E-4625 Curbside	6.50"	3864354	
		E-4624 Roadside		3864353	
9000	1965	E-4637 Curbside	3.875"	2330712	
		E-4636 Roadside		2330713	

A80, N80, Q80, V80

King Pin Kits

Axle Rating Lbs.	Axle Code/Year	Part Number/ Bushing Type	King Pin Size	Type	OEM Reference	Notes
7000	1965	E-4443B Bronze	1.249" x 7.888"	A	3927943	
		E-4443N Nylon				
9000	1965	E-4435B Bronze	8.750"	D	8885021	Tapered pin.
		E-4435N Bronze, Nylon			2321013	
11000	1965	E-4434B Bronze	9.750"	D	2264897	Tapered pin.
		E-4434N Bronze, Nylon				

Tie Rod Ends

Axle Rating Lbs.	Axle Code/Year	Part Number/ Location	Stud Center to Rod End	OEM Reference	Notes
7000	1965	E-4625 Curbside	6.50"	3864354	
		E-4624 Roadside		3864353	
9000	1965	E-4637 Curbside	3.875"	2330712	
		E-4636 Roadside		2330713	

GMC/CHEVROLET

B60, B6P, B6000

King Pin Kits

Axle Rating Lbs.	Axle Code/Year	Part Number/ Bushing Type	King Pin Size	Type	OEM Reference	Notes
6000	(F070) 1979-82	E-4443B Bronze	1.249" x 7.888"	A	3927943	
		E-4443N Nylon				
7000	(F070) 1979-91	E-4443B Bronze	1.249" x 7.888"	A	3927943	
		E-4443N Nylon				
7500	(F070) 1979-91	E-4443B Bronze	1.249" x 7.888"	A	3927943	
		E-4443N Nylon				
8100	(F090D) 1983-87	E-4435B Bronze	8.750"	D	2321013	Tapered pin.
		E-4435N Bronze, Nylon			8885021	
9000	(F090) 1979-82	E-4435B Bronze	8.750"	D	2321013	Tapered pin.
		E-4435N Bronze, Nylon			8885021	
	(F090) 1983-88	E-4469B Bronze	1.745" x 9.380"	B	8885621	
	(F120D) 1979-92	E-4469B Bronze				
12000	(F120) 1983-92	E-4469B Bronze	1.745" x 9.380"	B	8885621	Second design.

Tie Rod Ends

Axle Rating Lbs.	Axle Code/Year	Part Number/ Location	Stud Center to Rod End	OEM Reference	Notes	
6000	(F070D) 1979-82	E-4613 Curbside	4.938"	462390		
		E-4612 Roadside		462389		
7000, 7500	(F070) 1979-92	E-4613 Curbside	4.938"	462390		
		E-4612 Roadside		462389		
	(F070) 1988-92	E-6855 Curbside	10.81"	15622069		
		E-6854 Roadside		15622068		
8100	(F090) 1983-92	E-4609 Curbside	4.875"	2037140	Has three piece grease retainer.	
		E-4608 Roadside		2037142		
9000	(F090) 1980-82	E-4607 Curbside	4.875"	671489	Rubber dust boot.	
		E-4606 Roadside		671488		
	(F090), (F120D) 1979-92	E-4609 Curbside	4.875"	2037140	Has three piece grease retainer.	
		E-4608 Roadside		2037142		
12000	(F120) 1980-82	E-4607 Curbside	4.875"	671489		
		E-4606 Roadside		671488		
	(F120) 1983-92	E-4609 Curbside	4.875"	2037140		Has three piece grease retainer.
		E-4608 Roadside		2037142		

Drag Links

Axle Rating Lbs.	Axle Code/Year	Part Number	Stud Center to Stud Center	OEM Reference	Notes
6000	(F070) 1979-82	E-6816	17.00"	718797, 15506689	
7000	(F070) 1979-91	E-6816	17.00"	718797, 15506689	
8100	(F090D) 1983-88	E-5373	17.96"	718798	
9000	(F090) 1979-88	E-5373	17.96"	718798	
	(F120D) 1979-91	E-5373			
	(F120D) 1988-91	E-6833			
12000	(F120) 1979-90	E-5373	17.96"	718798	



GMC/CHEVROLET

B70, C7500, Kodiak, TopKick

King Pin Kits

Axle Rating Lbs.	Axle Code/Year	Part Number/ Bushing Type	King Pin Size	Type	OEM Reference	Notes
7000	(F070) 1979-92	E-4443B Bronze	1.249" x 7.888"	A	3927943	
		E-4443N Nylon				
8100	(F090D) 1984-92	E-4469B Bronze	1.745" x 9.380"	B	8885621	
	(FL1) 1990-00	E-10104B Bronze	1.614" x 8.035"	D	12540328	
9000	(F090) 1979-87	E-4435B Bronze	8.750"	D	2321013	Tapered pin.
		E-4435N Bronze, Nylon			8885021	
	(F120D) 1979-90	E-4469B Bronze	1.745" x 9.380"	B	8885621	
9000, 11000	(F43), (FL2) 1993-99	E-10105B Bronze	1.892" x 9.188"	D	12540329	
12000	(F120) 1979-90	E-4469B Bronze	1.745" x 9.380"	B	8885621	
	(FS7) 1990-99	E-10105B Bronze	1.892" x 9.188"	D	12540329	Hydraulic brakes
	(FS7) 1991-99	E-10106B Bronze	1.892" x 9.594"		12540330	Air brakes
14000	(FH0), (FL3) 1990-94	E-10106B Bronze	1.892" x 9.594"	D	12540330	
16000	1993-95	E-6194B Bronze	1.873" x 9.965"	A	12541348	

Tie Rod Ends

Axle Rating Lbs.	Axle Code/Year	Part Number/ Location	Stud Center to Rod End	OEM Reference	Notes	
7000	(F070) 1979-90	E-4613 Curbside	4.938"	462390		
		E-4612 Roadside		462389		
	(F070) 1988-92	E-6855 Curbside	10.81"	15622069		
		E-6854 Roadside		15622068		
8100	(F090) 1983-87	E-4613 Curbside	4.938"	462390		
		E-4612 Roadside		462389		
	(FL1) 1990-94	E-10113 Curbside	5.02"	12549195		First design
		E-10112 Roadside		12549194		
	(FL1) 1994-99	E-10111 Curbside	5.44"	12548111		Second design
		E-10110 Roadside		12548110		
9000	(F090) 1979-82	E-4607 Curbside	4.875"	671489	Except 2035126 axle assembly. Rubber dust boot.	
		E-4606 Roadside		671488		
	(F090) 1979-92	E-4609 Curbside		2037140	For 2035126 axle assembly.	
		E-4608 Roadside		2037142	Has three piece grease retainer.	
	(F120D) 1980-85	E-4607 Curbside		671489	Rubber dust boot.	
		E-4606 Roadside		671488		
	(F120D) 1983-92	E-4609 Curbside		2037140	Has three piece grease retainer.	
		E-4608 Roadside		2037142		
9000, 11000, 12000, 14000	(F43), (FL2), (FS7), (FH0), (FL3) 1990-00	E-10109 Curbside	5.44"	12548108		
		E-10108 Roadside		12548107		
12000	(F120) 1979-86	E-4607 Curbside	4.875"	671489	Rubber dust boot.	
		E-4606 Roadside		671488		
	(F120) 1983-92	E-4609 Curbside		2037140	Has three piece grease retainer.	
		E-4608 Roadside		2037142		
16000	(FH4) 1993-00	E-4629 Curbside	7.37"	12541320		
		E-4628 Roadside		12541319		

GMC/CHEVROLET

B70, C7500, Kodiak, TopKick (Continued)

Drag Links

Axle Rating Lbs.	Axle Code/Year	Part Number	Stud Center to Stud Center	OEM Reference	Notes
7000	(F070) 1979-92	E-6816	17.00"	71897, 15506689	1979-82 All; 1983-88 w/Saginaw power steering; 1988-92 w/power steering except Saginaw.
8100	(F090D) 1983-87	E-5373	17.96"	718798	
9000	(F090) 1979-88	E-5373	17.96"	718798	
	(F090D) 1979-90	E-5373			Except Saginaw power steering.
	(F120D) 1988-90	E-6833	18.50"	15625713	w/Saginaw power steering.
12000	(F120) 1979-90	E-5372	17.93"	718796	Use w/power ram cylinder.
	(F120) 1988-92	E-6834	18.58"	15622057	w/Power steering, use power ram cylinder.

Bison, General, N9E, N9F

King Pin Kits

Axle Rating Lbs.	Axle Code/Year	Part Number/ Bushings Type	King Pin Size	Type	OEM Reference	Notes
9000, 10860	(F120D) 1979-80	E-4469B Bronze	1.745" x 9.380"	B	8885621	
12000	(F120) 1975-87	E-4469B Bronze	1.745" x 9.380"	B	8885621	
	(FF931) 1979-87	E-4468B Bronze	1.794" x 10.392"		2010021	
		E-4694C Composite			15510849	
	(FF933) 1979-80	E-4468B Bronze			2010021	
		E-4694C Composite			15510849	
16000, 18000	(FL931) 1977-88	E-4458B Bronze	1.999" x 11.212"	B	2036352	
		E-4458C Composite			15585841	
18000	(FL941) 1979-87	E-4458B Bronze	1.999" x 11.212"	B	2036352	
		E-4458C Composite			15585841	

Tie Rod Ends

Axle Rating Lbs.	Axle Code/Year	Part Number/ Location	Stud Center to Rod End	OEM Reference	Notes
9000, 10860	(F120D) 1979-80	E-4609 Curbside	4.875"	2037140	Has three piece grease retainer.
		E-4608 Roadside		2037142	
12000	(F120) 1977-87	E-4609 Curbside	4.875"	2037140	Has three piece grease retainer.
		E-4608 Roadside		2037142	
		E-4607 Curbside		671489	
		E-4606 Roadside		671488	
	(FF931) 1979-87	E-4615 Curbside	5.44"	698572	
		E-4614 Roadside		698571	
	(FF933) 1977-80	E-4607 Curbside	4.875"	671489	w/Axle models 2015558, 559, 580; 2019775; 2030613. Rubber dust boot.
		E-4606 Roadside		671488	
		E-4615 Curbside	5.44"	698572	
		E-4614 Roadside		698571	
(FF933) 1979-80	E-4609 Curbside	4.875"	2037140	Has three piece grease retainer.	
	E-4608 Roadside		2037142		
(FF941) 1986-87	E-4615 Curbside	5.44"	698572, 15515805		
	E-4614 Roadside		698571, 15515804		
16000	(FL931) 1977-87	E-4629 Curbside	7.37"	798203	use w/794290; 2025885 axles.
		E-4628 Roadside		798204	
18000	(FL931) 1979-87	E-4629 Curbside	7.37"	798203	
		E-4628 Roadside		798204	
	(FL941) 1979-87	E-4629 Curbside		798203	
		E-4628 Roadside		798204	

GMC/CHEVROLET

Bison, General, N9E, N9F (Continued)

Drag Links

Axle Rating Lbs.	Axle Code/Year	Part Number	Stud Center to Stud Center	OEM Reference	Notes
9000, 10860	(F120D) 1979-80	E-5326	17.70"	669335	w/Power steering.
		E-5374	17.90"	684196	w/Manual steering.
12000	(F120) 1977-84	E-6815	16.89"	15501673	w/Ross power steering 1983-87.
		E-5326	17.70"	669335	w/Saginaw power steering 1983-84.
		E-5374	17.90"	684196	w/Manual steering 1983-85.
		E-6815	16.89"	15501673	w/Ross or Sheppard pwr. strg. 1983-87.
	(F120) 1977-87	E-5326	17.70"	669335	w/Saginaw power steering.
		E-5374	17.90"	684196	w/Manual steering.
	(FF931) 1979-84	E-5326	17.70"	669335	w/Power steering.
	(FF931) 1983	E-5326			
	(FF933) 1977-84	E-5374	17.90"	684196	w/Manual steering.
		E-5326	17.70"	669335	w/Power steering.
(FF941) 1986-87	E-5374	17.90"	684196	w/Manual steering.	
	E-6815	16.89"	15501673	w/Ross or Sheppard pwr. strg. 1983-87.	
16000	(FL931) 1977-84	E-5326	17.70"	669335	w/Power steering - LH.
18000	(FL931) 1979-84	E-5326	17.70"	669335	w/Power steering - LH.
		E-6815	16.89"	15501673	w/Ross or Sheppard pwr. steering - LH.
	(FL931) 1983-87	E-6817		15501674	w/Sheppard power steering - RH.
		E-5326	17.70"	669335	w/Saginaw power steering.
	(FL941) 1977-84	E-6815	16.89"	15501673	w/Ross or Sheppard pwr. steering - LH.
	(FL941) 1983-87	E-6817		15501674	w/Sheppard power steering - RH.
	(FL941) 1984-87	E-6815		15501673	w/Ross or Sheppard pwr. steering - LH.
		E-6817		15501674	w/Sheppard power steering - RH.

Bruin, Brigadier, J8C, J9C

King Pin Kits

Axle Rating Lbs.	Axle Code/Year	Part Number/ Bushings Type	King Pin Size	Type	OEM Reference	Notes
7000	(F070) 1979-88	E-4443B Bronze	1.249" x 7.888"	A	3927943	
		E-4443N Nylon				
9000	(F090) 1979-84	E-4435B Bronze	8.750"	D	2321013	Tapered pin.
		E-4435N Bronze, Nylon			8885021	
	(F120D) 1979-82	E-4469B Bronze	1.745" x 9.380"	B	8885621	
10860	(F120D) 1979-82	E-4469B Bronze	1.745" x 9.380"	B	8885621	
12000	(F120) 1979-88	E-4469B Bronze	1.745" x 9.380"	B	8885621	
	(FF941) 1985-87	E-4694C Composite	1.794" x 10.392"		15510849	
16000	(FL931) 1979-88	E-4458B Bronze	1.999" x 11.212"	B	2036352	
		E-4458C Composite			15585841	
18000	(FL931), (FL941) 1979-88	E-4458B Bronze	1.999" x 11.212"	B	2036352	
		E-4458C Composite			15585841	



an **ArvinMeritor**™ brand

GMC/CHEVROLET

Bruin, Brigadier, J8C, J9C (Continued)

Tie Rod Ends

Axle Rating Lbs.	Axle Code/Year	Part Number/ Location	Stud Center to Rod End	OEM Reference	Notes
7000	(F070) 1979-84	E-4613 Curbside	4.938"	462390	
		E-4612 Roadside		462389	
9000	(F090) 1979-88	E-4609 Curbside	4.875"	2037140	
		E-4608 Roadside		2037142	
	(F120D) 1979-88	E-4609 Curbside		2037140	
		E-4608 Roadside		2037142	
10860	(F120D) 1979-88	E-4609 Curbside	4.875"	2037140	
		E-4608 Roadside		2037142	
12000	(F120) 1979-88	E-4609 Curbside	4.875"	2037140	
		E-4608 Roadside		2037142	
	(FF941) 1979-88	E-4615 Curbside		698572	
		E-4614 Roadside		698571	
13200	(FF932) 1979-88	E-4615 Curbside	5.44"	698572	
		E-4614 Roadside		698571	
16000	(FL931) 1979-88	E-4629 Curbside	7.37"	798203	
		E-4628 Roadside		798204	
18000	(FL931), (FL941) 1979-88	E-4629 Curbside	7.37"	798203	
		E-4628 Roadside		798204	

Drag Links

Axle Rating Lbs.	Axle Code/Year	Part Number	Stud Center to Stud Center	OEM Reference	Notes
9000	(F090), (F120D) 1979-88	E-5326	17.70"	669335	w/Power steering.
		E-5374	17.90"	684196	w/Manual steering.
10860	(F120D) 1979-88	E-5326	17.70"	669335	w/Power steering.
		E-5374	17.90"	684196	w/Manual steering.
12000	(F120) 1979-82	E-6815	16.89"	15501673	w/Ross power steering.
	(F120) 1979-88	E-5326	17.70"	669335	w/Power steering.
		E-5374	17.90"	684196	w/Manual steering.
	(FF931) 1983-84	E-5374			
	(FF941) 1983-84	E-5374			
	(FF941) 1985-87	E-6815	16.89"	15501673	w/Sheppard power steering.
(FF932) 1979-88	E-5326	17.70"	669335	w/Power steering - LH.	
16000	(FL931) 1979-88	E-5326	17.70"	669335	w/Power steering - LH.
	(FL931) 1985-87	E-6815	16.89"	15501673	w/Sheppard power steering.
E-6817			15501674		
18000	(FL931) 1979-88	E-5326	17.70"	669335	w/Power steering - LH.
	(FL931), (FL941) 1985-87	E-6815	16.89"	15501673	w/Sheppard power steering.
		E-6817		15501674	
	(FL941) 1979-80	E-5326	17.70"	669335	w/Power steering - LH.

C40

King Pin Kits

Axle Rating Lbs.	Axle Code/Year	Part Number/ Bushing Type	King Pin Size	Type	OEM Reference	Notes
5000	(F050) 1964-72	E-4444B Bronze	1.109" x 6.343"	A	3927942	
		E-4444N Nylon				
7000	1971-72	E-4443B Bronze	1.249" x 7.888"	A	3927943	
		E-4443N Nylon				

GMC/CHEVROLET

C40 (Continued)

Tie Rod Ends

Axle Rating Lbs.	Axle Code/Year	Part Number/Location	Stud Center to Rod End	OEM Reference	Notes
5000	(F050) 1964-72	E-4621 Curbside	5.84"	3864348	
		E-4620 Roadside		3864347	
7000	1971-72	E-4625 Curbside	6.50"	3864354	
		E-4624 Roadside		3864353	

C50, C5D, C5000, E5500, H5500, C4500, E4500

King Pin Kits

Axle Rating Lbs.	Axle Code/Year	Part Number/Bushing Type	King Pin Size	Type	OEM Reference	Notes
5000	(F050) 1975-92	E-4453B Bronze	1.179" x 6.360"	A	722166	From 1975, second design.
	1964	E-4444B Bronze	1.109" x 6.343"		3927942	Second design w/thrust bearing.
		E-4444N Nylon				
5000/5500	1965-75	E-4444B Bronze	1.109" x 6.343"	A	3927942	
		E-4444N Nylon				
5000	1973-75	E-4430B Bronze	1.109" x 6.344"	A	3854744	Before 1975, second design.
7000	(F070) 1971-75	E-4443B Bronze	1.249" x 7.888"	A	3927943	
		E-4443N Nylon				

Tie Rod Ends

Axle Rating Lbs.	Axle Code/Year	Part Number/Location	Stud Center to Rod End	OEM Reference	Notes
5000	(F050) 1978-90	E-4613 Curbside	4.938"	462390	
		E-4612 Roadside		462389	
5000/5500	1963-77	E-4621 Curbside	5.84"	3864348	
		E-4620 Roadside		3864347	
7000	(F070) 1971-75	E-4625 Curbside	6.50"	3864354	
		E-4624 Roadside		3864353	

Drag Links

Axle Rating Lbs.	Axle Code/Year	Part Number	Stud Center to Stud Center	OEM Reference	Notes
5000	(F050) 1975-90	E-6816	17.00"	718797, 15506689	From 1975, second design.
7000	(F070) 1979-80	E-6816	17.00"	718797, 15506689	

C5500, Kodiak, TopKick

King Pin Kits

Axle Rating Lbs.	Axle Code/Year	Part Number/Bushing Type	King Pin Size	Type	OEM Reference	Notes
5000	(F050) 1975-92	E-4453B Bronze	1.179" x 6.360"	A	722166	From 1975, second design.
	1964	E-4444B Bronze	1.109" x 6.343"		3927942	Second design w/thrust bearing.
		E-4444N Nylon				
5000/5500	1965-75	E-4444B Bronze	1.109" x 6.343"	A	3927942	
		E-4444N Nylon				
5000	1973-75	E-4430B Bronze	1.109" x 6.344"	A	3854744	Before 1975, second design.
7000	(F070) 1971-75	E-4443B Bronze	1.249" x 7.888"	A	3927943	
		E-4443N Nylon				

C5500, Kodiak, TopKick (Continued)

Tie Rod Ends

Axle Rating Lbs.	Axle Code/Year	Part Number/ Location	Stud Center to Rod End	OEM Reference	Notes
5000	(F050) 1978-90	E-4613 Curbside	4.938"	462390	
		E-4612 Roadside		462389	
5000/5500	1963-77	E-4621 Curbside	5.84"	3864348	
		E-4620 Roadside		3864347	
7000	(F070) 1971-75	E-4625 Curbside	6.50"	3864354	
		E-4624 Roadside		3864353	
8100	(FL1) 1994-99		5.44"	12548111	Second Design
		E-10110 Roadside		12548110	
9000, 11000, 12000, 14000	(F43), (FL2), (FS7), (FH0), (FL3) 1990-00	E-10109 Curbside	5.44"	12548108	
		E-10108 Roadside		12548107	
16000	(FH4) 1993-00		7.37"	12541320	
		E-4628 Roadside		12541319	

Drag Links

Axle Rating Lbs.	Axle Code/Year	Part Number	Stud Center to Stud Center	OEM Reference	Notes
5000	(F050) 1975-90	E-6816	17.00"	718797, 15506689	From 1975, second design.
7000	(F070) 1979-80	E-6816	17.00"	718797, 15506689	

C60, C6D, C6000, C6H042, Kodiak, TopKick

Axle Rating Lbs.	Axle Code/Year	Part Number/ Bushing Type	King Pin Size	Type	OEM Reference	Notes
5000	(F050) 1975-90	E-4453B Bronze	1.179" x 6.360"	A	722166	Second design.
	1964-72	E-4444B Bronze	1.109" x 6.343"		3927942	First design.
					3972942	
	1973-75	E-4430B Bronze	1.109" x 6.344"		3854744	
7000	(F070) 1964-90	E-4443B Bronze	1.249" x 7.888"	A	3927943	
		E-4443N Nylon				
8100	(F090D) 1984-92	E-4469B Bronze	1.745" x 9.380"	B	8885621	
9000	(F090) 1963-87	E-4435B Bronze	8.750"	D	2321013	Tapered pin.
		E-4435N Bronze, Nylon			8885021	
	(F120D) 1983-92	E-4469B Bronze	1.745" x 9.380"	B	8885621	
12000	(F120) 1982-92	E-4469B Bronze	1.745" x 9.380"	B	8885621	

S.O.S.

Special Order Service

Can't find it?

Trouble sourcing products?

Need assistance?

Let Euclid's Special Order Service (**S.O.S.**) help you find your parts.

Euclid's position as the market leader provides you access to a comprehensive array of truck parts products from the industry's leading manufacturers. Through Euclid, these entire product lines are available to you just by placing a phone call to Euclid's S.O.S. Department at 866-238-2543 (option 2) in the U.S. or 800-387-3889 in Canada.

GMC/CHEVROLET

C60, C6D, C6000, C6H042, Kodiak, TopKick (Continued)

Tie Rod Ends

Axle Rating Lbs.	Axle Code/Year	Part Number/Location	Stud Center to Rod End	OEM Reference	Notes
5000	(F050) 1978-92	E-4613 Curbside	4.938"	462390	
		E-4612 Roadside		462389	
	1963-77	E-4621 Curbside	5.84"	3864348	
		E-4620 Roadside		3864347	
7000	(F070) 1978-90	E-4613 Curbside	4.938"	462390	
		E-4612 Roadside		462389	
	(F070) 1988-92	E-6855 Curbside	10.81"	15622069	
		E-6854 Roadside		15622068	
	1963-77	E-4625 Curbside	6.50"	3864354	
		E-4624 Roadside		3864353	
8100	(F090) 1984-92	E-4609 Curbside	4.875"	2037140	Has three piece grease retainer.
		E-4608 Roadside		2037142	
9000	(F090), (F120D) 1979-82	E-4607 Curbside	4.875"	671489	Rubber dust boot.
		E-4606 Roadside		671488	
	(F090), (F120D) 1983-92	E-4609 Curbside	4.875"	2037140	Has three piece grease retainer.
		E-4608 Roadside		2037142	
	1963-66	E-4637 Curbside	3.875"	2330712	
E-4636 Roadside		2330713			
12000	(F120) 1979-82	E-4607 Curbside	4.875"	671489	Rubber dust boot.
		E-4606 Roadside		671488	
	(F120) 1983-92	E-4609 Curbside	4.875"	2037140	Has three piece grease retainer.
		E-4608 Roadside		2037142	
		E-4608 Roadside		2037142	

Drag Links

Axle Rating Lbs.	Axle Code/Year	Part Number	Stud Center to Stud Center	OEM Reference	Notes
5000	(F050) 1975-92	E-6816	17.00"	718797, 15506689	From 1975, second design.
7000	(F070) 1975-92	E-6816	17.00"	718797, 15506689	1983-88 power steering exc. Saginaw. From 1975, second design.
8100	(F090D) 1983-87	E-5373	17.96"	718798	
9000	(F090) 1979-88	E-5373	17.96"	718798	1979-87 All; 1988-92 except Saginaw power steering.
	(F120D) 1979-92	E-5373			
	(F120D) 1988-92	E-6833	18.50"	15625713	
12000	(F120) 1988-90	E-6834	18.58"	15622057	w/Power steering and ram cylinder.
	(F120D) 1983-90	E-5372	17.93"	718796	Except ram cylinder.
		E-5373	17.96"	718798	
	(F120D) 1988-90	E-6833	18.50"	15625713	

If you detect any **errors** in this Catalog, please let us know.

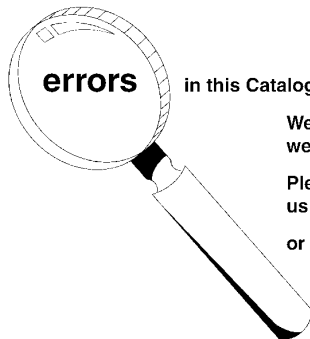

We want the information to be as accurate as possible; we appreciate your help in making it so.

Please e-mail any comments/suggestions/corrections to us at: catalogfeedback@arvinmeritor.com

or mail to: **Euclid Industries, LLC**
Attn: Catalog Dept.
7975 Dixie Highway
Florence, KY 41042-2754

Axle Rating Lbs.	Axle Code/Year	Part Number/ Bushing Type	King Pin Size	Type	OEM Reference	Notes
7000	(F070) 1973-78	E-4443B Bronze	1.249" x 7.888"	A	3927943	
		E-4443N Nylon				
9000	(F090) 1973-78	E-4435B Bronze	8.750"	D	2321013	Tapered pin.
		E-4435N Bronze, Nylon			8885021	
11000	(F120D) 1975-78	E-4469B Bronze	1.745" x 9.380"	B	8885621	
	(F110) 1969-72	E-4434B Bronze	9.750"	D	2264897	Tapered pin.
E-4434N Bronze, Nylon						
12000	(F120) 1973-75	E-4434B Bronze	9.750"	D	2264897	Tapered pin.
		E-4434N Bronze, Nylon				
	(F120) 1975-78	E-4469B Bronze	1.745" x 9.380"	B	8885621	

Tie Rod Ends

Axle Rating Lbs.	Axle Code/Year	Part Number/ Location	Stud Center to Rod End	OEM Reference	Notes
7000	(F070) 1973-78	E-4625 Curbside	6.50"	3864354	
		E-4624 Roadside		3864353	
9000	(F090), (F120D) 1975-78	E-4607 Curbside	4.875"	671489	Rubber dust boot.
		E-4606 Roadside		671488	
	(F120D) 1973-74	E-4637 Curbside	3.875"	2330712	
12000	(F120) 1973-78	E-4607 Curbside	4.875"	671489	
		E-4606 Roadside		671488	
	(F120) 1975-78	E-4609 Curbside	2037140, 2007728	w/Axle models 718934, 36, 37; 719597; 2000763; 2002084, 85, 86, 87. Has three piece grease retainer.	
		E-4608 Roadside	2037142, 2007731		

Drag Links

Axle Rating Lbs.	Axle Code/Year	Part Number	Stud Center to Stud Center	OEM Reference	Notes
7000	(F070) 1975-78	E-6816	17.00"	718797, 15506689	
9000	(F090) 1973-78	E-5392	3.12" Stud center to rod end	3892946	Power steering cylinder end.
		E-5372	17.93"	718796	
	(F090) 1975-78	E-5373	17.96"	718798	Second design.
	(F120D) 1975-78	E-6816	17.00"	718797	Second design. CD65-1978 only.
		E-5373	17.96"	718798	Second design.
12000	(F120) 1975-78	E-5392	3.12" Stud center to rod end	3892946	Second design. Power steering cylinder end.
		E-6816	17.00"	718797	Second design. CD65-1978 only.
		E-5373	17.96"	718798	Second design.



an **ArvinMeritor™** brand

GMC/CHEVROLET

C6500, Kodiak, TopKick

King Pin Kits

Axle Rating Lbs.	Axle Code/Year	Part Number/ Bushing Type	King Pin Size	Type	OEM Reference	Notes
7000	(F070) 1973-78	E-4443B Bronze	1.249" x 7.888"	A	3927943	
		E-4443N Nylon				
9000	(F090) 1973-78	E-4435B Bronze	8.750"	D	2321013	Tapered pin.
		E-4435N Bronze, Nylon			8885021	
11000	(F120D) 1975-78	E-4469B Bronze	1.745" x 9.380"	B	8885621	
		E-4434B Bronze				
12000	(F110) 1969-72	E-4434B Bronze	9.750"	D	2264897	Tapered pin.
		E-4434N Bronze, Nylon				
12000	(F120) 1973-75	E-4434B Bronze	9.750"	D	2264897	Tapered pin.
		E-4434N Bronze, Nylon				
	(F120) 1975-78	E-4469B Bronze	1.745" x 9.380"	B	8885621	

Tie Rod Ends

Axle Rating Lbs.	Axle Code/Year	Part Number/ Location	Stud Center to Rod End	OEM Reference	Notes
7000	(F070) 1973-78	E-4625 Curbside	6.50"	3864354	
		E-4624 Roadside		3864353	
8100	(FL1) 1994-99	E-10111 Curbside	5.44"	12548111	Second Design
		E-10110 Roadside		12548110	
9000	(F090), (F120D) 1975-78	E-4607 Curbside	4.875"	671489	Rubber dust boot.
		E-4606 Roadside		671488	
	(F120D) 1973-74	E-4637 Curbside	3.875"	2330712	
		E-4636 Roadside		2330713	
9000, 11000, 12000, 14000	(F43), (FL2), (FS7), (FH0), (FL3) 1990-00	E-10109 Curbside	5.44"	12548108	
		E-10108 Roadside		12548107	
12000	(F120) 1973-78	E-4607 Curbside	4.875"	671489	
		E-4606 Roadside		671488	
	(F120) 1975-78	E-4609 Curbside		2037140, 2007728	
		E-4608 Roadside		2037142, 2007731	
16000	(FH4) 1993-00	E-4629 Curbside	7.37"	12541320	w/Axle models 718934, 36, 37; 719597; 2000763; 2002084, 85, 86, 87. Has three piece grease retainer.
		E-4628 Roadside		12541319	

Drag Links

Axle Rating Lbs.	Axle Code/Year	Part Number	Stud Center to Stud Center	OEM Reference	Notes
7000	(F070) 1975-78	E-6816	17.00"	718797, 15506689	
9000	(F090) 1973-78	E-5392	3.12" Stud center to rod end	3892946	Power steering cylinder end.
		E-5372	17.93"	718796	
	(F090) 1975-78	E-5373	17.96"	718798	Second design.
	(F120D) 1975-78	E-6816	17.00"	718797	Second design. CD65-1978 only.
		E-5373	17.96"	718798	Second design.
12000	(F120) 1975-78	E-5392	3.12" Stud center to rod end	3892946	Second design. Power steering cylinder end.
		E-6816	17.00"	718797	Second design. CD65-1978 only.
		E-5373	17.96"	718798	Second design.

GMC/CHEVROLET

C70, C7D, C7H042, C7H064, Kodiak, TopKick

King Pin Kits

Axle Rating Lbs.	Axle Code/Year	Part Number/ Bushing Type	King Pin Size	Type	OEM Reference	Notes
7000	(F070) 1979-92	E-4443B Bronze	1.249" x 7.888"	A	3927943	
		E-4443N Nylon				
8100	(F090D) 1984-92	E-4469B Bronze	1.745" x 9.380"	B	8885621	
9000	(F090) 1979-87	E-4435B Bronze	8.750"	D	2321013	Tapered pin.
		E-4435N Bronze, Nylon			8885021	
12000	(F120D) 1979-90	E-4469B Bronze	1.745" x 9.380"	B	8885621	
	(F120) 1979-90	E-4469B Bronze	1.745" x 9.380"	B	8885621	

Tie Rod Ends

Axle Rating Lbs.	Axle Code/Year	Part Number/ Location	Stud Center to Rod End	OEM Reference	Notes
7000	(F070) 1979-90	E-4613 Curbside	4.938"	462390	
		E-4612 Roadside		462389	
	(F070) 1988-92	E-6855 Curbside	10.81"	15622069	
		E-6854 Roadside		15622068	
8100	(F090) 1983-87	E-4613 Curbside	4.938"	462390	
		E-4612 Roadside		462389	
9000	(F090) 1979-82	E-4607 Curbside	4.875"	671489	Except 2035126 axle assembly. Rubber dust boot.
		E-4606 Roadside		671488	
	(F090) 1979-92	E-4609 Curbside		2037140	For 2035126 axle assembly. Has three piece grease retainer.
		E-4608 Roadside		2037142	
	(F120D) 1980-85	E-4607 Curbside		671489	Rubber dust boot.
		E-4606 Roadside		671488	
	(F120D) 1983-92	E-4609 Curbside		2037140	Has three piece grease retainer.
		E-4608 Roadside		2037142	
12000	(F120) 1979-86	E-4607 Curbside	4.875"	671489	Rubber dust boot.
		E-4606 Roadside		671488	
	(F120) 1983-92	E-4609 Curbside		2037140	Has three piece grease retainer.
		E-4608 Roadside		2037142	

Drag Links

Axle Rating Lbs.	Axle Code/Year	Part Number	Stud Center to Stud Center	OEM Reference	Notes
7000	(F070) 1979-92	E-6816	17.00"	71897, 15506689	1979-82 All; 1983-88 w/Saginaw power steering; 1988-92 w/power steering except Saginaw.
8100	(F090D) 1983-87	E-5373	17.96"	718798	
9000	(F090) 1979-88	E-5373	17.96"	718798	
	(F090D) 1979-90	E-5373			
	(F120D) 1988-90	E-6833	18.50"	15625713	
12000	(F120) 1979-90	E-5372	17.93"	718796	Use w/power ram cylinder.
	(F120) 1988-92	E-6834	18.58"	15622057	w/Power steering, use power ram cylinder.



an **ArvinMeritor**™ brand

GMC/CHEVROLET

C8500, Kodiak, TopKick

Tie Rod Ends

Axle Rating Lbs.	Axle Code/Year	Part Number/ Location	Stud Center to Rod End	OEM Reference	Notes
8100	(FL1) 1994-99	E-10111 Curbside	5.44"	12548111	Second Design
		E-10110 Roadside		12548110	
9000, 11000, 12000, 14000	(F43), (FL2), (FS7), (FH0), (FL3) 1990-00	E-10109 Curbside	5.44"	12548108	
		E-10108 Roadside		12548107	
16000	(FH4) 1993-00	E-4629 Curbside	7.37"	12541320	
		E-4628 Roadside		12541319	

C9500

King Pin Kits

Axle Rating Lbs.	Axle Code/Year	Part Number/ Bushing Type	King Pin Size	Type	OEM Reference	Notes
9000	(F090) 1963-69	E-4435B Bronze	8.750"	D	2321013	Tapered pin.
		E-4435N Bronze, Nylon			8885021	
12000	(F120) 1973-78	E-4434B Bronze	9.750"	D	2264897	Tapered pin.
		E-4434N Bronze, Nylon				

Tie Rod Ends

Axle Rating Lbs.	Axle Code/Year	Part Number/ Location	Stud Center to Rod End	OEM Reference	Notes
9000	(F090) 1963-69	E-4637 Curbside	3.875"	2330712	
		E-4636 Roadside		2330713	

D50

King Pin Kits

Axle Rating Lbs.	Axle Code/Year	Part Number/ Bushing Type	King Pin Size	Type	OEM Reference	Notes
5000	1965-66	E-4444B Bronze	1.109" x 6.343"	A	3927942	
		E-4444N Nylon				

Tie Rod Ends

Axle Rating Lbs.	Axle Code/Year	Part Number/ Location	Stud Center to Rod End	OEM Reference	Notes
5000	1965-66	E-4621 Curbside	5.84"	3864348	
		E-4620 Roadside		3864347	

If you detect any

errors

in this Catalog, please let us know.

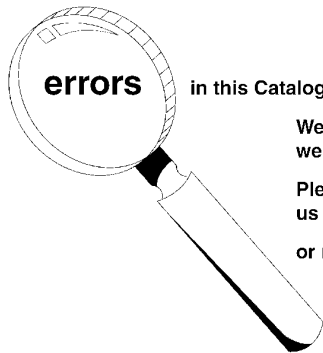

We want the information to be as accurate as possible; we appreciate your help in making it so.

Please e-mail any comments/suggestions/corrections to us at: catalogfeedback@arvinmeritor.com

or mail to:

Euclid Industries, LLC
Attn: Catalog Dept.
7975 Dixie Highway
Florence, KY 41042-2754

King Pin Kits

Axle Rating Lbs.	Axle Code/Year	Part Number/ Bushings Type	King Pin Size	Type	OEM Reference	Notes
5000	1964-70	E-4444B Bronze	1.109" x 6.343"	A	3927942	From 1964, second design.
		E-4444N Nylon				
7000	1964-70	E-4443B Bronze	1.249" x 7.888"	A	3927943	From 1964, second design.
		E-4443N Nylon				
9000	1963-70	E-4435B Bronze	8.750"	D	2321013	Tapered pin.
		E-4435N Bronze, Nylon			8885021	
11000	1965-70	E-4434B Bronze	9.750"	D	2264897	Tapered pin.
		E-4434N Bronze, Nylon				

Tie Rod Ends

Axle Rating Lbs.	Axle Code/Year	Part Number/ Location	Stud Center to Rod End	OEM Reference	Notes
5000	1963-70	E-4621 Curbside	5.84"	3864348	
		E-4620 Roadside		3864347	
7000	1963-70	E-4625 Curbside	6.50"	3864354	
		E-4624 Roadside		3864353	
9000	1963-70	E-4637 Curbside	3.875"	2330712	
		E-4636 Roadside		2330713	

D90, D9500

King Pin Kits

Axle Rating Lbs.	Axle Code/Year	Part Number/ Bushings Type	King Pin Size	Type	OEM Reference	Notes
9000	(F090) 1963-69	E-4435B Bronze	8.750"	D	2321013	Tapered pin.
		E-4435N Bronze, Nylon			8885021	
11000	(F110) 1963-69	E-4434B Bronze	9.750"	D	2264897	Tapered pin.
		E-4434N Bronze, Nylon				
12000	(F120) 1975-78	E-4469B Bronze	1.745" x 9.380"	B	8885621	Tapered pin.
	(F120), (FE970) 1970-74	E-4434B Bronze	9.750"	D	2264897	
		E-4434N Bronze, Nylon				
(FE970) 1966-68	E-4449B Bronze	1.607" x 8.740"	B	2442145	Center point steering.	
16000, 18000	(FL901) 1969-78	E-4454B Bronze	1.999" x 11.040"	B	2452865	
		E-4454N Nylon				
16000	(FL931) 1973-78	E-4458B Bronze	1.999" x 11.212"	B	2036352	
		E-4458C Composite			15585841	



an **ArvinMeritor™** brand

GMC/CHEVROLET

D90, D9500 (Continued)

Tie Rod Ends

Axle Rating Lbs.	Axle Code/Year	Part Number/Location	Stud Center to Rod End	OEM Reference	Notes
9000	(F090) 1963-69	E-4637 Curbside	3.875"	2330712	
		E-4636 Roadside		2330713	
12000	(F120) 1970-75	E-4607 Curbside	4.875"	671489	Before 1975 second design. Rubber dust boot.
		E-4606 Roadside		671488	
	(F120) 1975-78	E-4609 Curbside		2037140	From 1975 second design. Has three piece grease retainer.
		E-4608 Roadside		2037142	
	(FE900) 1970-72	E-4611 Curbside		2456811	
		E-4610 Roadside		2456810	
16000	(F160) 1970-72	E-4607 Curbside	4.875"	671489	Rubber dust boot.
		E-4606 Roadside		671488	
16000, 18000	(FL901)	E-4617 Curbside	5.75"	2452860	
		E-4616 Roadside		2452861	
16000	(FL931) 1973-74	E-4617 Curbside	5.75"	2452860	
		E-4616 Roadside		2452861	
	(FL931) 1975-78	E-4629 Curbside	7.37"	798203	
		E-4628 Roadside		798204	

Drag Links

Axle Rating Lbs.	Axle Code/Year	Part Number	Stud Center to Stud Center	OEM Reference	Notes
	(All)	E-5374	17.90"	684196	Color coded white.

F90

King Pin Kits

Axle Rating Lbs.	Axle Code/Year	Part Number/Bushing Type	King Pin Size	Type	OEM Reference	Notes
12000	(F120) 1975-78	E-4469B Bronze	1.745" x 9.380"	B	8885621	Tapered pin.
	(F120), (FE900) 1970-74	E-4434B Bronze	9.750"	D	2264897	
		E-4434N Bronze, Nylon				

Tie Rod Ends

Axle Rating Lbs.	Axle Code/Year	Part Number/Location	Stud Center to Rod End	OEM Reference	Notes
12000	(F120) 1970-75	E-4607 Curbside	4.875"	671489	Before 1975 second design. Rubber dust boot.
		E-4606 Roadside		671488	
	(F120) 1975-78	E-4609 Curbside		2037140	From 1975 second design. Has three piece grease retainer.
		E-4608 Roadside		2037142	
	(FE900) 1970-72	E-4611 Curbside		2456811	
		E-4610 Roadside		2456810	

Drag Links

Axle Rating Lbs.	Axle Code/Year	Part Number	Stud Center to Stud Center	OEM Reference	Notes
12000	(All)	E-5374	17.90"	684196	Color coded white.

GMC/CHEVROLET

F9500

King Pin Kits

Axle Rating Lbs.	Axle Code/Year	Part Number/ Bushings Type	King Pin Size	Type	OEM Reference	Notes
9000	(F090) 1963-69	E-4435B Bronze	8.750"	D	2321013	Tapered pin.
		E-4435N Bronze, Nylon			8885021	
11000	(F110) 1963-69	E-4434B Bronze	9.750"	D	2264897	Tapered pin.
		E-4434N Bronze, Nylon				
12000	(F120) 1963-74	E-4434B Bronze	9.750"	D	2264897	Tapered pin.
		E-4434N Bronze, Nylon				
	(FE970) 1966-68	E-4449B Bronze	1.607" x 8.740"	B	2442145	Center point steering.

Tie Rod Ends

Axle Rating Lbs.	Axle Code/Year	Part Number/ Location	Stud Center to Rod End	OEM Reference	Notes
9000	(F090) 1963-69	E-4637 Curbside	3.875"	2330712	
		E-4636 Roadside		2330713	
12000	(F120) 1970-74	E-4607 Curbside	4.875"	671489	Rubber dust boot.
		E-4606 Roadside		671488	
	(F120) 1975-78	E-4609 Curbside		2007728	Has three piece grease retainer.
		E-4608 Roadside		2007731	
16000	(F160) 1970-72	E-4607 Curbside	4.875"	671489	Rubber dust boot.
		E-4606 Roadside		671488	

Drag Links

Axle Rating Lbs.	Axle Code/Year	Part Number	Stud Center to Stud Center	OEM Reference	Notes
12000	All 1973-78	E-5374	17.90"	684196	Color coded white.

H70, H7500

King Pin Kits

Axle Rating Lbs.	Axle Code/Year	Part Number/ Bushings Type	King Pin Size	Type	OEM Reference	Notes
7000	(F070) 1966-78	E-4443B Bronze	1.249" x 7.888"	A	3927943	
		E-4443N Nylon				
9000	(F090) 1966-78	E-4435B Bronze	8.750"	D	2321013	Tapered pin.
		E-4435N Bronze, Nylon			8885021	
11000	(F110) 1966-72	E-4434B Bronze	9.750"	D	2264897	Tapered pin.
		E-4434N Bronze, Nylon				
12000	(F120) 1966-74	E-4434B Bronze	9.750"	D	2264897	Tapered pin.
		E-4434N Bronze, Nylon				
	(F120) 1975-78	E-4469B Bronze	1.745" x 9.380"	B	8885621	
16000	(FL901) 1966-72	E-4454B Bronze	1.999" x 11.040"	B	2452865	
		E-4454N Nylon				

GMC/CHEVROLET

H70, H7500 (Continued)

Tie Rod Ends

Axle Rating Lbs.	Axle Code/Year	Part Number/Location	Stud Center to Rod End	OEM Reference	Notes	
7000	(F070) 1966-78	E-4625 Curbside	6.50"	3864354		
		E-4624 Roadside		3864353		
	(F070) 1978	E-4613 Curbside	4.938"	462390		
		E-4612 Roadside		462389		
9000	(F090) 1966-78	E-4637 Curbside	3.875"	2330712	1966-72 All; 1973-78 w/688568 axle only.	
		E-4636 Roadside		2330713		
	(F090) 1973-78	E-4609 Curbside	4.875"	2037140		Exc. 688561; 688568; 2000765, 7, 8; 2002081, 83 axles.
		E-4608 Roadside		2037142		
12000	(F120) 1973-78	E-4609 Curbside	4.875"	2037140	Exc. 688561; 688568; 2000765, 7, 8; 2002081, 83 axles.	
		E-4608 Roadside		2037142		
16000	(FL901) 1966-72	E-4617 Curbside	5.75"	2452860		
		E-4616 Roadside		2452861		

Drag Links

Axle Rating Lbs.	Axle Code/Year	Part Number	Stud Center to Stud Center	OEM Reference	Notes
7000	(F070) 1973-78	E-5374	17.90"	684196	w/Manual steering.
9000	(F090) 1973-78	E-5326	17.70"	669335	w/Power steering.
		E-5374	17.90"	684196	w/Manual steering.
	(F120D) 1973-78	E-5326	17.70"	669335	w/Power steering.
		E-5374	17.90"	684196	w/Manual steering.
12000	(F120) 1973-78	E-5326	17.70"	669335	w/Power steering.
		E-5374	17.90"	684196	w/Manual steering.

H80, H8500

King Pin Kits

Axle Rating Lbs.	Axle Code/Year	Part Number/Bushing Type	King Pin Size	Type	OEM Reference	Notes
7000	(F070) 1973-78	E-4443B Bronze	1.249" x 7.888"	A	3927943	
		E-4443N Nylon				
9000	(F090) 1973-78	E-4435B Bronze	8.750"	D	2321013 8885021	Tapered pin.
		E-4435N Bronze, Nylon				
12000	(F120) 1973-74	E-4434B Bronze	9.750"	D	2264897	Tapered pin.
		E-4434N Bronze, Nylon				
	(F120) 1975-78	E-4469B Bronze	1.745" x 9.380"	B	8885621	

Tie Rod Ends

Axle Rating Lbs.	Axle Code/Year	Part Number/Location	Stud Center to Rod End	OEM Reference	Notes
7000	(F070) 1973-78	E-4625 Curbside	6.50"	3864354	
		E-4624 Roadside		3864353	
9000	(F090) 1973-78	E-4609 Curbside	4.875"	2037140	Exc. 688561; 688568; 2000765, 7, 8; 2002081, 83 axles.
		E-4608 Roadside		2037142	
12000	(F120) 1973-78	E-4609 Curbside	4.875"	2037140	Exc. 688561; 688568; 2000765, 7, 8; 2002081, 83 axles.
		E-4608 Roadside		2037142	

GMC/CHEVROLET
H80, H8500 (Continued)

Drag Links

Axle Rating Lbs.	Axle Code/Year	Part Number	Stud Center to Stud Center	OEM Reference	Notes
7000	(F070) 1973-78	E-5374	17.90"	684196	w/Manual steering.
9000	(F090) 1973-78	E-5326	17.70"	669335	w/Power steering.
		E-5374	17.90"	684196	w/Manual steering.
12000	(F120) 1973-78	E-5326	17.70"	669335	w/Power steering.
		E-5374	17.90"	684196	w/Manual steering.

H90, H9500

King Pin Kits

Axle Rating Lbs.	Axle Code/Year	Part Number/ Bushing Type	King Pin Size	Type	OEM Reference	Notes
7000	(F070) 1966-72	E-4443B Bronze	1.249" x 7.888"	A	3927943	
		E-4443N Nylon				
9000	(F090) 1970-78	E-4435B Bronze	8.750"	D	2321013 8885021	Tapered pin.
		E-4435N Bronze, Nylon				
	(F120D) 1975-78	E-4469B Bronze	1.745" x 9.380"	B	8885621	
12000	(F120) 1975-78	E-4469B Bronze	1.745" x 9.380"	B	8885621	
	(F120, FE900) 1970-74	E-4434B Bronze	9.750"	D	2264897	Tapered pin.
		E-4434N Bronze, Nylon				

Tie Rod Ends

Axle Rating Lbs.	Axle Code/Year	Part Number/ Location	Stud Center to Rod End	OEM Reference	Notes	
7000	(F070) 1966-72	E-4625 Curbside	6.50"	3864354		
		E-4624 Roadside		3864353		
9000	(F090) 1966-69	E-4637 Curbside	3.875"	2330712		
		E-4636 Roadside		2330713		
	(F090) 1970-78	E-4607 Curbside	4.875"	671489		Rubber dust boot.
		E-4606 Roadside		671488		
	(F120D) 1975-78	E-4607 Curbside	4.875"	671489		Rubber dust boot.
		E-4606 Roadside		671488		
12000	(F120) 1970-75	E-4607 Curbside	4.875"	671489	Before 1975 second design. Rubber dust boot.	
		E-4606 Roadside		671488		
	(F120) 1975-78	E-4609 Curbside	4.875"	2037140	From 1975 second design. Has three piece grease retainer.	
		E-4608 Roadside		2037142		
	(FE900) 1970-72	E-4611 Curbside	4.875"	2456811		
		E-4610 Roadside		2456810		
16000	(F160) 1970-72	E-4607 Curbside	4.875"	671489		
		E-4606 Roadside		671488		

Drag Links

Axle Rating Lbs.	Axle Code/Year	Part Number	Stud Center to Stud Center	OEM Reference	Notes
9000	(F090) 1970-78	E-5326	17.70"	669335	w/Power steering.
		E-5374	17.90"	684196	w/Manual steering.
12000	(F120) 1970-78	E-5326	17.70"	669335	w/Power steering.
		E-5374	17.90"	684196	w/Manual steering.

GMC/CHEVROLET

J70, J7500

King Pin Kits

Axle Rating Lbs.	Axle Code/Year	Part Number/ Bushing Type	King Pin Size	Type	OEM Reference	Notes
7000	(F070) 1966-78	E-4443B Bronze	1.249" x 7.888"	A	3927943	
		E-4443N Nylon				
9000	(F090) 1966-78	E-4435B Bronze	8.750"	D	2321013	Tapered pin.
		E-4435N Bronze, Nylon			8885021	
11000	(F120D) 1975-78	E-4469B Bronze	1.745" x 9.380"	B	8885621	
	(F110) 1966-72	E-4434B Bronze	9.750"	D	2264897	Tapered pin.
E-4434N Bronze, Nylon						
12000	(F120) 1966-74	E-4434B Bronze	9.750"	D	2264897	Tapered pin.
		E-4434N Bronze, Nylon				
16000, 18000	(FL901) 1966-78	E-4469B Bronze	1.745" x 9.380"	B	8885621	
		E-4454B Bronze	1.999" x 11.040"	B	2452865	
(FL931) 1973-78	E-4454N Nylon	1.999" x 11.212"	2036352			
	E-4458B Bronze		15585841			
		E-4458C Composite				

Tie Rod Ends

Axle Rating Lbs.	Axle Code/Year	Part Number/ Location	Stud Center to Rod End	OEM Reference	Notes
7000	(F070) 1966-78	E-4625 Curbside	6.50"	3864354	
		E-4624 Roadside		3864353	
	(F070) 1978	E-4613 Curbside	4.938"	462390	Use w/6V-53 engine and 465018 axle.
		E-4612 Roadside		462389	
9000	(F090) 1966-78	E-4637 Curbside	3.875"	2330712	1966-72 All; 1973-78 w/688568 axle only.
		E-4636 Roadside		2330713	
	(F090) 1973-78	E-4609 Curbside	4.875"	2037140	Except 688561; 688568; 2000765, 7, 8; 2002081, 83 axles.
		E-4608 Roadside		2037142	
(F120D) 1974-78	E-4609 Curbside		2037140		
	E-4608 Roadside		2037142		
12000	(F120) 1973-78	E-4609 Curbside	4.875"	2037140	Except 688561; 688568; 2000765, 7, 8; 2002081, 83 axles.
		E-4608 Roadside		2037142	
16000, 18000	(FL901) 1966-78	E-4617 Curbside	5.75"	2452860	
		E-4616 Roadside		2452861	
	(FL931) 1973-78	E-4629 Curbside	7.37"	798203	Use w/718314, 719708; 719831; 2025882, 886 axles.
		E-4628 Roadside		798204	

Drag Links

Axle Rating Lbs.	Axle Code/Year	Part Number	Stud Center to Stud Center	OEM Reference	Notes
7000	(F070) 1973-78	E-5374	17.90"	684196	w/Manual steering.
9000	(F090) 1973-78	E-5374	17.90"	684196	Use w/6V-53; 432; 478M engines.
	(F090), (F120D) 1970-78	E-5326	17.70"	669335	w/Power steering.
		E-5374	17.90"	684196	w/Manual steering.
12000	(F120) 1970-78	E-5326	17.70"	669335	w/Power steering.
		E-5374	17.90"	684196	w/Manual steering.
16000, 18000	(FL901) 1973-78	E-5374	17.90"	684196	w/Manual steering.
	(FL931) 1973-78	E-5326	17.70"	669335	w/Power steering - RH

King Pin Kits

Axle Rating Lbs.	Axle Code/Year	Part Number/ Bushings Type	King Pin Size	Type	OEM Reference	Notes
9000	(F090) 1973-78	E-4435B Bronze	8.750"	D	2321013	Tapered pin.
		E-4435N Bronze, Nylon			8885021	
12000	(F120) 1973-74	E-4434B Bronze	9.750"	D	2264897	Tapered pin.
		E-4434N Bronze, Nylon			2664897	
16000, 18000	(F120) 1975-78	E-4469B Bronze	1.745" x 9.380"	B	8885621	
	(FL901) 1973-74	E-4454B Bronze	1.999" x 11.040"	B	2452865	
	E-4454N Nylon					

Tie Rod Ends

Axle Rating Lbs.	Axle Code/Year	Part Number/ Location	Stud Center to Rod End	OEM Reference	Notes
9000	(F090) 1973-78	E-4609 Curbside	4.875"	2037140	Except 688561; 688568; 2000765, 7, 8; 2002081, 83 axles.
		E-4608 Roadside		2037142	
12000	(F120) 1973-78	E-4609 Curbside	4.875"	2037140	Except 688561; 688568; 2000765, 7, 8; 2002081, 83 axles.
		E-4608 Roadside		2037142	
16000, 18000	(FL901) 1973-74	E-4617 Curbside	5.75"	2452860	
		E-4616 Roadside		2452861	

Drag Links

Axle Rating Lbs.	Axle Code/Year	Part Number	Stud Center to Stud Center	OEM Reference	Notes
9000	(F090) 1973-74	E-5326	17.70"	669335	w/Power steering.
		E-5374	17.90"	684196	w/Manual steering. Use w/6V-53; 432; 478M engines.
12000	(F120) 1973-74	E-5326	17.70"	669335	w/Power steering.
		E-5374	17.90"	684196	w/Manual steering.
16000, 18000	(FL901) 1973-74	E-5374	17.90"	684196	w/Manual steering. Use w/6V-53; 432; 478M engines.

King Pin Kits

Axle Rating Lbs.	Axle Code/Year	Part Number/ Bushings Type	King Pin Size	Type	OEM Reference	Notes
9000	(F090) 1963-78	E-4435B Bronze	8.750"	D	2321013	Tapered pin.
		E-4435N Bronze, Nylon			8885021	
12000	(F120) 1963-74	E-4434B Bronze	9.750"	D	2264897	Tapered pin.
		E-4434N Bronze, Nylon				
	(FL901) 1973-74	E-4454B Bronze	1.999" x 11.040"	B	2452865	
		E-4454N Nylon				



an **ArvinMeritor**™ brand

GMC/CHEVROLET

J8500 (Continued)

Tie Rod Ends

Axle Rating Lbs.	Axle Code/Year	Part Number/Location	Stud Center to Rod End	OEM Reference	Notes
9000	(F090) 1963-72	E-4637 Curbside	3.875"	2330712	
		E-4636 Roadside		2330713	
	(F090), (F120) 1973-78	E-4607 Curbside	4.875"	671489	
		E-4606 Roadside		671488	
12000	(F120) 1973-78	E-4607 Curbside	4.875"	671489	
		E-4606 Roadside		671488	
16000	(FL901) 1973-74	E-4617 Curbside	5.75"	2452860	
		E-4616 Roadside		2452861	

Drag Links

Axle Rating Lbs.	Axle Code/Year	Part Number	Stud Center to Stud Center	OEM Reference	Notes
9000	(F090) 1973-78	E-5326	17.70"	669335	w/Power steering.
		E-5374	17.90"	684196	w/Manual steering. Use w/6V-53; 432; 478 engines.
12000	(F120) 1973-78	E-5326	17.70"	669335	w/Power steering.
		E-5374	17.90"	684196	
16000	(FL901) 1973-74	E-5374	17.90"	684196	w/6V-53 engine.

J90, J9500

King Pin Kits

Axle Rating Lbs.	Axle Code/Year	Part Number/Bushing Type	King Pin Size	Type	OEM Reference	Notes
9000	(F090) 1970-78	E-4435B Bronze	8.750"	D	2321013	Tapered pin.
		E-4435N Bronze, Nylon			8885021	
12000	(F120) 1970-74	E-4434B Bronze	9.750"	D	2264897	Tapered pin.
		E-4434N Bronze, Nylon				
16000, 18000	(FL901) 1970-78	E-4454B Bronze	1.999" x 11.040"	B	2452865	
		E-4454N Nylon				
16000	(FL931) 1973-78	E-4458B Bronze	1.999" x 11.212"	B	2036352	
		E-4458C Composite			15585841	

Tie Rod Ends

Axle Rating Lbs.	Axle Code/Year	Part Number/Location	Stud Center to Rod End	OEM Reference	Notes
9000	(F090) 1963-69	E-4637 Curbside	3.875"	2330712	
		E-4636 Roadside		2330713	
	(F090) 1970-78	E-4607 Curbside	4.875"	671489	
		E-4606 Roadside		671488	
12000	(F120) 1970-75	E-4607 Curbside	4.875"	671489	Before 1975 second design.
		E-4606 Roadside		671488	Rubber dust boot.
	(F120) 1975-78	E-4609 Curbside	4.875"	2037140	From 1975 second design.
		E-4608 Roadside		2037142	Has three piece grease retainer.
	(FE900) 1970-72	E-4611 Curbside	4.875"	2456811	
		E-4610 Roadside		2456810	
16000	(F160) 1970-72	E-4607 Curbside	4.875"	671489	Rubber dust boot.
		E-4606 Roadside		671488	
16000, 18000	(FL901) 1973-78	E-4617 Curbside	5.75"	2452860	
		E-4616 Roadside		2452861	
16000	(FL931) 1973-78	E-4629 Curbside	7.37"	798203	w/Axle models 718314; 719708; 719831; 2025882, 86 axles.
		E-4628 Roadside		798204	

GMC/CHEVROLET
J90, J9500 (Continued)

Drag Links

Axle Rating Lbs.	Axle Code/Year	Part Number	Stud Center to Stud Center	OEM Reference	Notes
9000	(F090) 1970-78	E-5326	17.70"	669335	w/Power steering.
		E-5374	17.90"	684196	w/Manual steering.
12000	(F120) 1970-78	E-5326	17.70"	669335	w/Power steering.
		E-5374	17.90"	684196	w/Manual steering.
16000	(FL931) 1973-78	E-5326	17.70"	669335	w/Power steering - LH

L50

King Pin Kits

Axle Rating Lbs.	Axle Code/Year	Part Number/ Bushings Type	King Pin Size	Type	OEM Reference	Notes
5000	1964	E-4444B Bronze	1.109" x 6.343"	A	3927942	Second design w/thrust bearing.
		E-4444N Nylon				
	1965-70	E-4444B Bronze				
		E-4444N Nylon				
7000	1965-70	E-4443B Bronze	1.249" x 7.888"	A	3927943	
		E-4443N Nylon				
9000	1965-70	E-4435B Bronze	8.750"	D	2321013 8885021	Tapered pin.
		E-4435N Bronze, Nylon				
11000	1965-70	E-4434B Bronze	9.750"	D	2264897	Tapered pin.
		E-4434N Bronze, Nylon				

Tie Rod Ends

Axle Rating Lbs.	Axle Code/Year	Part Number/ Location	Stud Center to Rod End	OEM Reference	Notes
5000	1963-66	E-4621 Curbside	5.84"	3864348	
		E-4620 Roadside		3864347	
7000	1965-70	E-4625 Curbside	6.50"	3864354	
		E-4624 Roadside		3864353	
9000	1965-70	E-4637 Curbside	3.875"	2330712	
		E-4636 Roadside		2330713	

L60, C80, E80, L80, M80, U80

King Pin Kits

Axle Rating Lbs.	Axle Code/Year	Part Number/ Bushings Type	King Pin Size	Type	OEM Reference	Notes
5000	1965-66	E-4444B Bronze	1.109" x 6.343"	A	3927942	
		E-4444N Nylon				
7000	1964-66	E-4443B Bronze	1.249" x 7.888"	A	3927943	
		E-4443N Nylon				
9000	1963-66	E-4435B Bronze	8.750"	D	2321013 8885021	Tapered pin.
		E-4435N Bronze, Nylon				
11000	1963-66	E-4434B Bronze	9.750"	D	2264897	Tapered pin.
		E-4434N Bronze, Nylon				

GMC/CHEVROLET

L60, C80, E80, L80, M80, U80 (Continued)

Tie Rod Ends

Axle Rating Lbs.	Axle Code/Year	Part Number/ Location	Stud Center to Rod End	OEM Reference	Notes
5000	1965-66	E-4621 Curbside	5.84"	3864348	
		E-4620 Roadside		3864347	
7000	1963-66	E-4625 Curbside	6.50"	3864354	
		E-4624 Roadside		3864353	
9000	1963-66	E-4637 Curbside	3.875"	2330712	
		E-4636 Roadside		2330713	

M50

King Pin Kits

Axle Rating Lbs.	Axle Code/Year	Part Number/ Bushing Type	King Pin Size	Type	OEM Reference	Notes
5000	1967-70	E-4444B Bronze	1.109" x 6.343"	A	3927942	
		E-4444N Nylon				
7000	1967-72	E-4443B Bronze	1.249" x 7.888"	A	3927943	
		E-4443N Nylon				
9000	1967-70	E-4435B Bronze	8.750"	D	2321013	Tapered pin.
		E-4435N Bronze, Nylon			8885021	

Tie Rod Ends

Axle Rating Lbs.	Axle Code/Year	Part Number/ Location	Stud Center to Rod End	OEM Reference	Notes
5000	1967-70	E-4621 Curbside	5.84"	3864348	
		E-4620 Roadside		3864347	
7000	1967-73	E-4625 Curbside	6.50"	3864354	
		E-4624 Roadside		3864353	
9000	1967-70	E-4637 Curbside	3.875"	2330712	
		E-4636 Roadside		2330713	

M60, M6000

King Pin Kits

Axle Rating Lbs.	Axle Code/Year	Part Number/ Bushing Type	King Pin Size	Type	OEM Reference	Notes
5000	1964-70	E-4444B Bronze	1.109" x 6.343"	A	3927942	First design.
		E-4444N Nylon				
7000	1964-78	E-4443B Bronze	1.249" x 7.888"	A	3927943	
		E-4443N Nylon				
9000	1963-78	E-4435B Bronze	8.750"	D	2321013	Tapered pin.
		E-4435N Bronze, Nylon			8885021	
11000	1965-70	E-4434B Bronze	9.750"	D	2264897	Tapered pin.
		E-4434N Bronze, Nylon				
12000	(F120) 1975-78	E-4469B Bronze	1.745" x 9.380"	B	8885621	Tapered pin.
	1973-75	E-4434B Bronze	9.750"	D	2264897	
		E-4434N Bronze, Nylon				

GMC/CHEVROLET
M60, M6000 (Continued)

Tie Rod Ends

Axle Rating Lbs.	Axle Code/Year	Part Number/ Location	Stud Center to Rod End	OEM Reference	Notes
5000	1963-70	E-4621 Curbside	5.84"	3864348	
		E-4620 Roadside		3864347	
7000	1963-78	E-4625 Curbside	6.50"	3864354	w/Axle models 348136, 42; 349041, 42, 44, 46, 47, 48, 52, 53, 59, 60; 45977.
		E-4624 Roadside		3864353	
	1973-78	E-4613 Curbside	4.938"	462390	
		E-4612 Roadside		462389	
9000	1963-74	E-4637 Curbside	3.875"	2330712	
		E-4636 Roadside		2330713	
	1975-78	E-4607 Curbside	4.875"	671489	
		E-4606 Roadside		671488	
12000	1973-78	E-4607 Curbside	4.875"	671489	
		E-4606 Roadside		671488	

Drag Links

Axle Rating Lbs.	Axle Code/Year	Part Number	Stud Center to Stud Center	OEM Reference	Notes
7000, 9000, 12000	1978	E-6816	17.00"	718797, 15506689	

M65, M6500

King Pin Kits

Axle Rating Lbs.	Axle Code/Year	Part Number/ Bushing Type	King Pin Size	Type	OEM Reference	Notes
7000	(F070) 1973-78	E-4443B Bronze	1.249" x 7.888"	A	3927943	
		E-4443N Nylon				
9000	(F090) 1973-78	E-4435B Bronze	8.750"	D	2321013	Tapered pin.
		E-4435N Bronze, Nylon			8885021	
	(F120D) 1975-78	E-4469B Bronze	1.745" x 9.380"	B	8885621	
11000	(F110) 1969-72	E-4434B Bronze	9.750"	D	2264897	Tapered pin.
		E-4434N Bronze, Nylon				
12000	(F120) 1973-75	E-4434B Bronze	9.750"	D	2264897	Tapered pin.
		E-4434N Bronze, Nylon				
	(F120) 1975-78	E-4469B Bronze	1.745" x 9.380"	B	8885621	

Tie Rod Ends

Axle Rating Lbs.	Axle Code/Year	Part Number/ Location	Stud Center to Rod End	OEM Reference	Notes
7000	(F070) 1973-78	E-4625 Curbside	6.50"	3864354	
		E-4624 Roadside		3864353	
9000	(F090) 1973-74	E-4637 Curbside	3.875"	2330712	
		E-4636 Roadside		2330713	
	(F090), (F120D) 1975-78	E-4607 Curbside	4.875"	671489	
		E-4606 Roadside		671488	
12000	(F120) 1973-78	E-4607 Curbside	4.875"	671489	Rubber dust boot.
		E-4606 Roadside		671488	
	(F120) 1975-78	E-4609 Curbside		2037140, 2007728	
		E-4608 Roadside		2037142, 2007731	

GMC/CHEVROLET

M65, M6500 (Continued)

Drag Links

Axle Rating Lbs.	Axle Code/Year	Part Number	Stud Center to Stud Center	OEM Reference	Notes
7000	(F070) 1975-78	E-6816	17.00"	718797, 15506689	Second design.
9000	(F090) 1975-78	E-5392	3.12" Stud center to rod end	3892946	Power steering cylinder end.
		E-5373	17.96"	718798	Second design.
	(F120D) 1975-78	E-6816	17.00"	718797	
		E-5373	17.96"	718798	
1973-78	E-5392	3.12" Stud center to rod end	3892946	Power steering cylinder end.	
12000	(F120) 1973-78	E-5392	3.12" Stud center to rod end	3892946	Power steering cylinder end.

M90, M9500

King Pin Kits

Axle Rating Lbs.	Axle Code/Year	Part Number/ Bushing Type	King Pin Size	Type	OEM Reference	Notes
9000	(F090) 1970-78	E-4435B Bronze	8.750"	D	2321013	Tapered pin.
		E-4435N Bronze, Nylon			8885021	
12000	(F120D) 1975-78	E-4469B Bronze	1.745" x 9.380"	B	8885621	
	(F120) 1975-78	E-4469B Bronze	1.745" x 9.380"	B	8885621	
	(F120), (FE900) 1970-74	E-4434B Bronze	9.750"	D	2264897	Tapered pin.
		E-4434N Bronze, Nylon				
16000	(FL901) 1970-78	E-4454B Bronze	1.999" x 11.040"	B	2452865	
		E-4454N Nylon				
	(FL931) 1973-78	E-4458B Bronze	1.999" x 11.212"		2036352	
		E-4458C Composite			15585841	
18000	(FL901) 1973-78	E-4454B Bronze	1.999" x 11.040"	B	2452865	
		E-4454N Nylon			720383	

Tie Rod Ends

Axle Rating Lbs.	Axle Code/Year	Part Number/ Location	Stud Center to Rod End	OEM Reference	Notes	
9000	(F090) 1963-69	E-4637 Curbside	3.875"	2330712		
		E-4600 Roadside		2330713		
	(F090) 1970-78	E-4607 Curbside	4.875"	671489		Rubber dust boot.
		E-4606 Roadside		671488		
(F120D) 1975-78	E-4607 Curbside		671489			
	E-4606 Roadside		671488			
12000	(F120) 1970-75	E-4607 Curbside	4.875"	671489	Before 1975 second design.	
		E-4606 Roadside		671488	Rubber dust boot.	
	(F120) 1975-78	E-4609 Curbside		2037140	From 1975 second design.	
		E-4608 Roadside		2037142	Has three piece grease retainer.	
	(FE900) 1970-72	E-4611 Curbside		2456811		
		E-4610 Roadside		2456810		
16000	(F160) 1970-72	E-4607 Curbside	4.875"	671489	Rubber dust boot.	
		E-4606 Roadside		671488		
	(FL901) 1973-78	E-4617 Curbside	5.75"	2456860		
E-4616 Roadside			2456861			
18000	(FL901) 1973-78	E-4617 Curbside	5.75"	2452861		
		E-4616 Roadside		2452860		

GMC/CHEVROLET
M90, M9500 (Continued)

Drag Links

Axle Rating Lbs.	Axle Code/Year	Part Number	Stud Center to Stud Center	OEM Reference	Notes
9000	(F090) 1970-78	E-5326	17.70"	669335	w/Power steering.
		E-5374	17.90"	684196	w/Manual steering.
12000	(F120) 1970-78	E-5326	17.70"	669335	w/Power steering.
		E-5374	17.90"	684196	w/Manual steering.
16000	(FL931) 1973-78	E-5326	17.70"	669335	w/Power steering - LH

N50

King Pin Kits

Axle Rating Lbs.	Axle Code/Year	Part Number/ Bushings Type	King Pin Size	Type	OEM Reference	Notes
7000	1965-66	E-4443B Bronze	1.249" x 7.888"	A	3927943	
		E-4443N Nylon				
9000	1965-66	E-4435B Bronze	8.750"	D	2321013 8885021	Tapered pin.
		E-4435N Bronze, Nylon				

Tie Rod Ends

Axle Rating Lbs.	Axle Code/Year	Part Number/ Location	Stud Center to Rod End	OEM Reference	Notes
7000	1965-66	E-4625 Curbside	6.50"	3864354	
		E-4624 Roadside		3864353	
9000	1965-66	E-4637 Curbside	3.875"	2330712	
		E-4636 Roadside		2330713	

N60, Y60

King Pin Kits

Axle Rating Lbs.	Axle Code/Year	Part Number/ Bushings Type	King Pin Size	Type	OEM Reference	Notes
7000	1965-66	E-4443B Bronze	1.249" x 7.888"	A	3927943	
		E-4443N Nylon				
9000	1965-66	E-4435B Bronze	8.750"	D	2321013 8885021	Tapered pin.
		E-4435N Bronze, Nylon				
11000	1965-66	E-4434B Bronze	9.750"	D	2264897	Tapered pin.
		E-4434N Bronze, Nylon				

Tie Rod Ends

Axle Rating Lbs.	Axle Code/Year	Part Number/ Location	Stud Center to Rod End	OEM Reference	Notes
7000	1965-66	E-4625 Curbside	6.50"	3864354	
		E-4624 Roadside		3864353	
9000	1965-66	E-4637 Curbside	3.875"	2330712	
		E-4636 Roadside		2330713	

P1500 (1/2 Ton) 2WD

King Pin Kits

Axle Rating Lbs.	Axle Code/Year	Part Number/ Bushings Type	King Pin Size	Type	OEM Reference	Notes
	1966	E-4430B Bronze	1.109" x 6.344"	A	3854744	

GMC/CHEVROLET

P1500 (1/2 Ton) 2WD (Continued)

Tie Rod Ends

Axle Rating Lbs.	Axle Code/Year	Part Number/Location	Stud Center to Rod End	OEM Reference	Notes
	1966	E-4621 Curbside	5.84"	3864348	
		E-4620 Roadside		3864347	

P2500 (3/4 Ton) 2WD

King Pin Kits

Axle Rating Lbs.	Axle Code/Year	Part Number/Bushing Type	King Pin Size	Type	OEM Reference	Notes
	1960-63	E-4430B Bronze	1.109" x 6.344"	A	3854744	
	1964-65	E-4444B Bronze	1.109" x 6.343"		3927942	
		E-4444N Nylon				
	1966	E-4430B Bronze	1.109" x 6.344"		3854744	
	1967	E-4444B Bronze	1.109" x 6.343"		3927942	
		E-4444N Nylon				

Tie Rod Ends

Axle Rating Lbs.	Axle Code/Year	Part Number/Location	Stud Center to Rod End	OEM Reference	Notes
	1960-63	E-4621 Curbside	5.84"	3864348	
		E-4620 Roadside		3864347	
	1966-67	E-4621 Curbside		3864348	
		E-4620 Roadside		3864347	

P40

King Pin Kits

Axle Rating Lbs.	Axle Code/Year	Part Number/Bushing Type	King Pin Size	Type	OEM Reference	Notes
5000	(F050) 1979-90	E-4453B Bronze	1.179" x 6.360"	A	722166, 15536398	
7000	(F070) 1979-84	E-4443B Bronze	1.249" x 7.888"	A	8885857	
		E-4443N Nylon				

Tie Rod Ends

Axle Rating Lbs.	Axle Code/Year	Part Number/Location	Stud Center to Rod End	OEM Reference	Notes
5000, 7000	(F050), (F070) 1979-90	E-4613 Curbside	4.938"	462390	
		E-4612 Roadside		462389	

P4500

King Pin Kits

Axle Rating Lbs.	Axle Code/Year	Part Number/Bushing Type	King Pin Size	Type	OEM Reference	Notes
5000	(F050) 1979-90	E-4453B Bronze	1.179" x 6.360"	A	722166	
7000	(F070) 1979-84	E-4443B Bronze	1.249" x 7.888"	A	8885857	
		E-4443N Nylon				

Tie Rod Ends

Axle Rating Lbs.	Axle Code/Year	Part Number/Location	Stud Center to Rod End	OEM Reference	Notes
5000, 7000	(F050), (F070) 1979-90	E-4613 Curbside	4.938"	462390	
		E-4612 Roadside		462389	

King Pin Kits

Axle Rating Lbs.	Axle Code/Year	Part Number/ Bushings Type	King Pin Size	Type	OEM Reference	Notes
5000	1965-66	E-4444B Bronze E-4444N Nylon	1.109" x 6.343"	A	3927942	

Tie Rod Ends

Axle Rating Lbs.	Axle Code/Year	Part Number/ Location	Stud Center to Rod End	OEM Reference	Notes
5000	1965-66	E-4621 Curbside	5.84"	3864348 3864347	

King Pin Kits

Axle Rating Lbs.	Axle Code/Year	Part Number/ Bushings Type	King Pin Size	Type	OEM Reference	Notes
5000	(F050) 1983-90	E-4453B Bronze	1.179" x 6.360"	A	1553698	
7000	(F070) 1983-90	E-4443B Bronze	1.249" x 7.888"	A	8885857	
8100	(FL1) 1992-96	E-10104B Bronze	1.614" x 8.035"	D	12540328	
9000	(F090) 1984-90 (F120D) 1987-90	E-4469B Bronze E-4469B Bronze	1.745" x 9.380"	B	8885856	
11000	(FL2) 1992-96	E-10105B Bronze	1.892" x 9.188"	D	12540329	
12000	(F120) 1983-90	E-4469B Bronze	1.745" x 9.380"	B	8885856	

Axle Rating Lbs.	Axle Code/Year	Part Number/ Location	Stud Center to Rod End	OEM Reference	Notes
5000	(F050) 1983-90	E-4612 Roadside	4.938"	462390 462389	
7000	(F070) 1983-87 (F070) 1988-90	E-4613 Curbside E-4612 Roadside E-6855 Curbside	4.938" 10.81"	462390 462389 15522069 15622068	
8000	(FL1) 1992-44 (FL1) 1992-94 (FL1) 1994-99	E-10112 Roadside E-10113 Curbside E-10111 Curbside	5.02" 5.44"	12549194 12549195 12548111 12548110	First design. Second design.
9000	(F090) 1983-90 (F120D) 1987-90	E-4609 Curbside E-4608 Roadside E-4609 Curbside	4.875"	2037140 2037142 2037140 2037142	
11000	(FL2) 1992-96	E-10108 Roadside	5.44"	12548108 12548107	
12000	(F120) 1983-90	E-4609 Curbside E-4608 Roadside	4.875"	2037140 2037142	



an **ArvinMeritor™** brand

GMC/CHEVROLET

P60 (Continued)

Drag Links

Axle Rating Lbs.	Axle Code/Year	Part Number	Stud Center to Stud Center	OEM Reference	Notes
5000	(F050) 1983-90	E-6816	17.00"	15506689	
7000	(F070) 1983-90	E-6816	17.00"	15506689	Except motor home applications.
9000	(F120D) 1983-90	E-5373	17.96"	718798	w/Saginaw power steering and hydraulic brakes.
	(F120D) 1988-90	E-6833	18.50"	15625713	
12000	(F120) 1983-90	E-5373	17.96"	718798	w/Saginaw power steering and hydraulic brakes.
	(F120) 1988-90	E-6833	18.50"	15625713	

P6000

King Pin Kits

Axle Rating Lbs.	Axle Code/Year	Part Number/ Bushing Type	King Pin Size	Type	OEM Reference	Notes
5000	(F050) 1983-90	E-4453B Bronze	1.179" x 6.360"	A	15536398	
7000	(F070) 1983-90	E-4443B Bronze	1.249" x 7.888"	A	8885857	
		E-4443N Nylon				
9000	(F090) 1984-90	E-4469B Bronze	1.745" x 9.380"	B	8885856	
12000	(F120) 1984-90	E-4469B Bronze	1.745" x 9.380"	B	8885856	

Tie Rod Ends

Axle Rating Lbs.	Axle Code/Year	Part Number/ Location	Stud Center to Rod End	OEM Reference	Notes
5000	(F050) 1983-90	E-4613 Curbside	4.938"	462390	
		E-4612 Roadside		462389	
7000	(F070) 1983-87	E-4613 Curbside	4.938"	462390	
		E-4612 Roadside		462389	
	(F070) 1988-90	E-6855 Curbside	10.81"	15622069	
		E-6854 Roadside		15622068	
9000	(F090) 1983-90	E-4609 Curbside	4.875"	2037140	
		E-4608 Roadside		2037142	

Drag Links

Axle Rating Lbs.	Axle Code/Year	Part Number	Stud Center to Stud Center	OEM Reference	Notes
5000	(F050) 1983-90	E-6816	17.00"	15506689	
7000	(F070) 1983-90	E-6816	17.00"	15506689	Except motor home applications.
9000	(F120D) 1983-90	E-5373	17.96"	718798	w/Saginaw power steering and hydraulic brakes.
	(F120D) 1988-90	E-6833	18.50"	15625713	

Q60, V60, X60

King Pin Kits

Axle Rating Lbs.	Axle Code/Year	Part Number/ Bushing Type	King Pin Size	Type	OEM Reference	Notes
5000	1965-66	E-4444B Bronze	1.109" x 6.343"	A	3927942	
		E-4444N Nylon				
7000	1965-66	E-4443B Bronze	1.249" x 7.888"	A	3927943	
		E-4443N Nylon				
9000	1965-66	E-4435B Bronze	8.750"	D	2321013	Tapered pin.
		E-4435N Bronze, Nylon			8885021	

GMC/CHEVROLET
Q60, V60, X60 (Continued)

Tie Rod Ends

Axle Rating Lbs.	Axle Code/Year	Part Number/ Location	Stud Center to Rod End	OEM Reference	Notes
5000	1965-66	E-4621 Curbside	5.84"	3864348	
		E-4620 Roadside		3864347	
7000	1965-66	E-4625 Curbside	6.50"	3864354	
		E-4624 Roadside		3864353	
9000	1965-66	E-4637 Curbside	3.875"	2330712	
		E-4636 Roadside		2330713	

R8500

King Pin Kits

Axle Rating Lbs.	Axle Code/Year	Part Number/ Bushing Type	King Pin Size	Type	OEM Reference	Notes
9000	(F090) 1973	E-4435B Bronze	8.750"	D	2321013	Tapered pin.
		E-4435N Bronze, Nylon			8885021	

Tie Rod Ends

Axle Rating Lbs.	Axle Code/Year	Part Number/ Location	Stud Center to Rod End	OEM Reference	Notes
9000	(F090) 1973	E-4607 Curbside	4.875"	671489	
		E-4606 Roadside		671488	

S50, Q50

King Pin Kits

Axle Rating Lbs.	Axle Code/Year	Part Number/ Bushing Type	King Pin Size	Type	OEM Reference	Notes
5000	1964	E-4444B Bronze	1.109" x 6.343"	A	3927942	Second design w/thrust bearing.
		E-4444N Nylon				
	1965-75	E-4444B Bronze				
		E-4444N Nylon				
7000	1964-75	E-4443B Bronze	1.249" x 7.888"	A	3927943	From 1964, second design.
		E-4443N Nylon				
9000	1963-72	E-4435B Bronze	8.750"	D	2321013	Tapered pin.
		E-4435N Bronze, Nylon			8885021	

Tie Rod Ends

Axle Rating Lbs.	Axle Code/Year	Part Number/ Location	Stud Center to Rod End	OEM Reference	Notes
5000	1963-75	E-4621 Curbside	5.84"	3864348	
		E-4620 Roadside		3864347	
7000	1963-75	E-4625 Curbside	6.50"	3864354	
		E-4624 Roadside		3864353	
9000	1962-72	E-4637 Curbside	3.875"	2330712	
		E-4636 Roadside		2330713	



GMC/CHEVROLET

S60, S6000

King Pin Kits

Axle Rating Lbs.	Axle Code/Year	Part Number/ Bushings Type	King Pin Size	Type	OEM Reference	Notes
5000	1964-69	E-4444B Bronze	1.109" x 6.343"	A	3927942	First design.
		E-4444N Nylon				
5500	1973-75	E-4444B Bronze	1.109" x 6.343"	A	3927942	First design.
		E-4444N Nylon				
	1975-79	E-4453B Bronze	1.179" x 6.360"		722166	Second design.
7000	1964-69	E-4443B Bronze	1.249" x 7.888"	A	3927943	
		E-4443N Nylon				
	1973-79	E-4443B Bronze				
	E-4443N Nylon					
9000	1965-69	E-4435B Bronze	8.750"	D	2321013	Tapered pin.
		E-4435N Bronze, Nylon			8885021	
	1973-79	E-4435B Bronze			2321013	Tapered pin, except F120D.
		E-4435N Bronze, Nylon			8885021	

Tie Rod Ends

Axle Rating Lbs.	Axle Code/Year	Part Number/ Location	Stud Center to Rod End	OEM Reference	Notes	
5000	1963-69	E-4621 Curbside	5.84"	3864348		
		E-4620 Roadside		3864347		
5500	1973-79	E-4621 Curbside	5.84"	3864348		
		E-4620 Roadside		3864347		
7000	1963-69	E-4625 Curbside	6.50"	3864354		
		E-4624 Roadside		3864353		
	1978-79	E-4613 Curbside	4.938"	462390		
		E-4612 Roadside		462389		
9000	1963-69	E-4637 Curbside	3.875"	2330712		
		E-4636 Roadside		2330713		
	1973-74	E-4637 Curbside		2330712		
		E-4636 Roadside		2330713		
	1975-79	E-4607 Curbside		4.875"		671489
		E-4606 Roadside				671488

Drag Links

Axle Rating Lbs.	Axle Code/Year	Part Number	Stud Center to Stud Center	OEM Reference	Notes
5500, 7000	1975-79	E-6816	17.00"	15506689, 718797	From 1975, second design.

S70, S7T, S7500

King Pin Kits

Axle Rating Lbs.	Axle Code/Year	Part Number/ Bushings Type	King Pin Size	Type	OEM Reference	Notes
12000	(F120) 1983-90	E-4469B Bronze	1.745" x 9.380"	B	8885621	
13200	(FG943) 1987-90	E-4468B Bronze	1.794" x 10.392"	B	2010021	
		E-4694C Composite			15510849	

GMC/CHEVROLET

S70, S7T, S7500 (Continued)

Tie Rod Ends

Axle Rating Lbs.	Axle Code/Year	Part Number/Location	Stud Center to Rod End	OEM Reference	Notes
9000, 12000	(F120D) 1983-90	E-4609 Curbside	4.875"	2037142	
		E-4608 Roadside		2037140	
13200	(FG943) 1987-90	E-4615 Curbside	5.44"	15515805, 698572	
		E-4614 Roadside		15515804, 698571	

Drag Links

Axle Rating Lbs.	Axle Code/Year	Part Number	Stud Center to Stud Center	OEM Reference	Notes
9000, 12000	(F120), (F120D) 1983-84	E-5326	17.70"	669335	w/Power steering.
13200	(FF932) 1983-84	E-5326	17.70"	669335	w/Power steering.

T50, T5500

King Pin Kits

Axle Rating Lbs.	Axle Code/Year	Part Number/Bushing Type	King Pin Size	Type	OEM Reference	Notes
5000	1965-72	E-4444B Bronze	1.109" x 6.343"	A	3927942	
		E-4444N Nylon				
7000	1965-72	E-4443B Bronze	1.249" x 7.888"	A	3927943	
		E-4443N Nylon				
8100	(FL1) 1997-00	E-10104B Bronze	1.614" x 8.035"	D	12540328	
9000	1965-72	E-4435B Bronze	8.750"	D	2321013	Tapered pin.
		E-4435N Bronze, Nylon			8885021	
11000	(FL2) 1997-00	E-10105B Bronze	1.892" x 9.188"	D	12540329	Tapered pin.
	1965-72	E-4434B Bronze	9.750"		2264897	
		E-4434N Bronze, Nylon				
12000	(FS7) 1997-00	E-10106B Bronze	1.892" x 9.594"	D	12540330	
14600	(FL3) 1997-00	E-10106B Bronze	1.892" x 9.594"	D	12540330	

Tie Rod Ends

Axle Rating Lbs.	Axle Code/Year	Part Number/Location	Stud Center to Rod End	OEM Reference	Notes
5000	1965-72	E-4621 Curbside	5.84"	3864348	
		E-4620 Roadside		3864347	
7000	1965-72	E-4625 Curbside	6.50"	3864354	
		E-4624 Roadside		3864353	
8100	(FL1) 1997	E-10111 Curbside	5.44"	12548111	
		E-10110 Roadside		12548110	
9000	1965-70	E-4637 Curbside	3.875"	2330712	
		E-4636 Roadside		2330713	
	1970-72	E-4607 Curbside	4.875"	671489	
		E-4606 Roadside		671488	
11000	(FL2) 1997	E-10109 Curbside	5.44"	12548108	
		E-10108 Roadside		12548107	
12000	(FS7) 1997	E-10109 Curbside	5.44"	12548108	
		E-10108 Roadside		12548107	
14600	(FL3) 1997	E-10109 Curbside	5.44"	12548108	
		E-10108 Roadside		12548107	

GMC/CHEVROLET

T60, T6000

King Pin Kits

Axle Rating Lbs.	Axle Code/Year	Part Number/ Bushings Type	King Pin Size	Type	OEM Reference	Notes
7000	1964-78	E-4443B Bronze	1.249" x 7.888"	A	3927943	
		E-4443N Nylon				
9000	1963-78	E-4435B Bronze	8.750"	D	2321013	Tapered pin.
		E-4435N Bronze, Nylon			8885021	
11000	1963-69	E-4434B Bronze	9.750"	D	2264897	Tapered pin.
		E-4434N Bronze, Nylon				
12000	1970-72	E-4434B Bronze	9.750"	D	2264897	Tapered pin.
		E-4434N Bronze, Nylon				

Tie Rod Ends

Axle Rating Lbs.	Axle Code/Year	Part Number/ Location	Stud Center to Rod End	OEM Reference	Notes
7000	1963-77	E-4625 Curbside	6.50"	3864354	
		E-4624 Roadside		3864353	
	1978	E-4613 Curbside	4.938"	462390	
		E-4612 Roadside		462389	
9000	1963-75	E-4637 Curbside	3.875"	2330712	First design.
		E-4636 Roadside		2330713	
	1975-78	E-4607 Curbside	4.875"	671489	Second design.
		E-4606 Roadside		671488	
12000	1970-72	E-4607 Curbside	4.875"	671489	
		E-4606 Roadside		671488	

T65, T6500

King Pin Kits

Axle Rating Lbs.	Axle Code/Year	Part Number/ Bushings Type	King Pin Size	Type	OEM Reference	Notes
7000	(F070) 1973-78	E-4443B Bronze	1.249" x 7.888"	A	3927943	
		E-4443N Nylon				
8100	(FL1) 1997-00	E-10104B Bronze	1.614" x 8.035"	D	12540328	Tapered pin.
9000	(F090) 1973-78	E-4435B Bronze	8.750"	D	2321013	Tapered pin.
		E-4435N Bronze, Nylon			8885021	
	(F120D) 1975-78	E-4469B Bronze	1.745" x 9.380"	B	8885621	
11000	(FL2) 1997-00	E-10105B Bronze	1.892" x 9.188"	D	12540329	Tapered pin.
12000	(F120) 1973-75	E-4434B Bronze	9.750"	D	2264897	Tapered pin.
		E-4434N Bronze, Nylon				
	(F120) 1975-78	E-4469B Bronze	1.745" x 9.380"	B	8885621	
	(FS7) 1997-00	E-10106B Bronze	1.892" x 9.594"	D	12540330	Tapered pin.
14600	(FL3) 1997-00	E-10106B Bronze	1.892" x 9.594"	D	12540330	Tapered pin.



an **ArvinMeritor**™ brand

GMC/CHEVROLET
T65, T6500 (Continued)

Tie Rod Ends

Axle Rating Lbs.	Axle Code/Year	Part Number/ Location	Stud Center to Rod End	OEM Reference	Notes
7000	(F070) 1973-78	E-4625 Curbside	6.50"	3864354	
		E-4624 Roadside		3864353	
8100	(FL1) 1997	E-10111 Curbside	5.44"	12548111	
		E-10110 Roadside		12548110	
9000	(F090) 1973-74	E-4637 Curbside	3.875"	2330712	
		E-4636 Roadside		2330713	
	(F090), (F120D) 1975-78	E-4607 Curbside	4.875"	671489	
		E-4606 Roadside		671488	
11000	(FL2) 1997	E-10109 Curbside	5.44"	12548108	
		E-10108 Roadside		12548107	
12000	(F120) 1973-78	E-4607 Curbside	4.875"	671489	Rubber dust boot.
		E-4606 Roadside		671488	
	(F120) 1975-78	E-4609 Curbside	5.44"	2037140, 2007728	w/Axle Models 718934, 36, 37; 719597; 2000763; 2002084, 85, 86, 87. Has three piece grease retainer.
		E-4608 Roadside		2037142, 2007731	
	(FS7) 1997	E-10109 Curbside	5.44"	12548108	
		E-10108 Roadside		12548107	
14600	(FL3) 1997	E-10109 Curbside	5.44"	12548108	
		E-10108 Roadside		12548107	

T70, T7500

King Pin Kits

Axle Rating Lbs.	Axle Code/Year	Part Number/ Bushing Type	King Pin Size	Type	OEM Reference	Notes
7000	(F070) 1966-78	E-4443B Bronze	1.249" x 7.888"	A	3927943	
		E-4443N Nylon				
8100	(FL1) 1997-00	E-10104B Bronze	1.614" x 8.035"	D	12540328	Tapered pin.
9000	(F090) 1966-78	E-4435B Bronze	8.750"	D	2321013	Tapered pin.
		E-4435N Bronze, Nylon			8885021	
11000	(F110) 1966-72	E-4434B Bronze	9.750"	D	2664897	Tapered pin.
		E-4434N Bronze, Nylon				
	(FL2) 1997-00	E-10105B Bronze	1.892" x 9.188"		12540329	
12000	(F120) 1966-74	E-4434B Bronze	9.750"	D	2264897	Tapered pin.
		E-4434N Bronze, Nylon				
	(F120) 1975-78	E-4469B Bronze	1.745" x 9.380"	B	8885621	
	(FS7) 1997-00	E-10106B Bronze	1.892" x 9.594"	D	12540330	Tapered pin.
14600	(FL3) 1997-00	E-10106B Bronze	1.892" x 9.594"	D	12540330	Tapered pin.

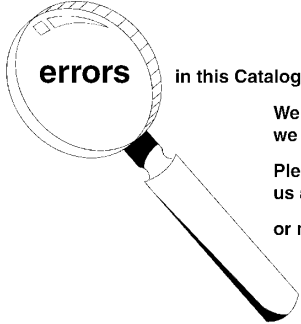

If you detect any **errors** in this Catalog, please let us know.

We want the information to be as accurate as possible; we appreciate your help in making it so.

Please e-mail any comments/suggestions/corrections to us at: catalogfeedback@arvinmeritor.com

or mail to: **Euclid Industries, LLC**
Attn: Catalog Dept.
7975 Dixie Highway
Florence, KY 41042-2754

GMC/CHEVROLET

T70, T7500 (Continued)

Tie Rod Ends

Axle Rating Lbs.	Axle Code/Year	Part Number/ Location	Stud Center to Rod End	OEM Reference	Notes	
7000	(F070) 1973-78	E-4625 Curbside	6.50"	3864354		
		E-4624 Roadside		3864353		
	(F070) 1978	E-4613 Curbside	4.938"	462390		Use w/6V-53 engine and 465018 axle.
		E-4612 Roadside		462389		
8100	(FL1) 1997	E-10111 Curbside	5.44"	12548111		
		E-10110 Roadside		12548110		
9000	(F090) 1966-78	E-4637 Curbside	3.875"	2330712	1966-72 All; 1973-78 w/688568 axle only.	
		E-4636 Roadside		2330713		
	(F090) 1972-78	E-4609 Curbside	4.875"	2037140	Except 688561; 688568; 2000765, 7, 8; 2002081, 83 axles.	
		E-4608 Roadside		2037142		
11000	(FL2) 1997	E-10109 Curbside	5.44"	12548108		
		E-10108 Roadside		12548107		
12000	(F120) 1973-78	E-4609 Curbside	4.875"	2037140	Except 688561; 688568; 2000765, 7, 8; 2002081, 83 axles.	
		E-4608 Roadside		2037142		
	(FS7) 1997	E-10109 Curbside	5.44"	12548108		
		E-10108 Roadside		12548107		
14600	(FL3) 1997	E-10109 Curbside	5.44"	12548108		
		E-10108 Roadside		12548107		

T80, T8500

King Pin Kits

Axle Rating Lbs.	Axle Code/Year	Part Number/ Bushing Type	King Pin Size	Type	OEM Reference	Notes
7000	1964-66	E-4443B Bronze	1.249" x 7.888"	A	3927943	From 1964, second design.
		E-4443N Nylon				
8100	(FL1) 1997-00	E-10104B Bronze	1.614" x 8.035"	D	12540328	Tapered pin.
9000	(F090) 1963-78	E-4435B Bronze	8.750"	D	2321013	Tapered pin.
		E-4435N Bronze, Nylon			8885021	
11000	(F110) 1963-66	E-4434B Bronze	9.750"	D	2264897	Tapered pin.
		E-4434N Bronze, Nylon				
	(FL2) 1997-00	E-10105B Bronze	1.892" x 9.188"		12540329	
12000	(F120) 1973-78	E-4434B Bronze	9.750"	D	2264897	Tapered pin.
		E-4434N Bronze, Nylon				
	(FS7) 1997-00	E-10106B Bronze	1.892" x 9.594"		12540330	
14600	(FL3) 1997-00	E-10106B Bronze	1.892" x 9.594"	D	12540330	Tapered pin.

S.O.S.

Special Order Service

Can't find it?

Trouble sourcing products?

Need assistance?

Let Euclid's Special Order Service (**S.O.S.**) help you find your parts.

Euclid's position as the market leader provides you access to a comprehensive array of truck parts products from the industry's leading manufacturers. Through Euclid, these entire product lines are available to you just by placing a phone call to Euclid's S.O.S. Department at 866-238-2543 (option 2) in the U.S. or 800-387-3889 in Canada.

GMC/CHEVROLET
T80, T8500 (Continued)

Tie Rod Ends

Axle Rating Lbs.	Axle Code/Year	Part Number/ Location	Stud Center to Rod End	OEM Reference	Notes
7000	1963-66	E-4625 Curbside	6.50"	3864354	
		E-4624 Roadside		3864353	
8100	(FL1) 1997	E-10111 Curbside	5.44"	12548111	
		E-10110 Roadside		12548110	
9000	(F090) 1973-78	E-4609 Curbside	4.875"	2037140	Exc. 688561; 688568; 2000765, 7, 8; 2002081, 83 axles.
		E-4608 Roadside		2037142	
	1963-66	E-4637 Curbside	3.875"	2330712	
		E-4636 Roadside		2330713	
11000	(FL2) 1997	E-10109 Curbside	5.44"	12548108	
		E-10108 Roadside		12548107	
12000	(F120) 1973-78	E-4609 Curbside	4.875"	2037140	Exc. 688561; 688568; 2000765, 7, 8; 2002081, 83 axles.
		E-4608 Roadside		2037142	
	(FS7) 1997	E-10109 Curbside	5.44"	12548108	
		E-10108 Roadside		12548107	
14600	(FL3) 1997	E-10109 Curbside	5.44"	12548108	
		E-10108 Roadside		12548107	

T90, T9500

King Pin Kits

Axle Rating Lbs.	Axle Code/Year	Part Number/ Bushing Type	King Pin Size	Type	OEM Reference	Notes
9000	(F090) 1963-72	E-4435B Bronze	8.750"	D	2321013	Tapered pin.
		E-4435N Bronze, Nylon			8885021	
11000	(F110) 1963-72	E-4434B Bronze	9.750"	D	2264897	Tapered pin.
		E-4434N Bronze, Nylon				
12000	(F120) 1963-78	E-4434B Bronze	9.750"	D	2264897	Tapered pin.
		E-4434N Bronze, Nylon				

Tie Rod Ends

Axle Rating Lbs.	Axle Code/Year	Part Number/ Location	Stud Center to Rod End	OEM Reference	Notes
9000	(F090) 1963-69	E-4637 Curbside	3.875"	2330712	
		E-4636 Roadside		2330713	
	(F090) 1970-72	E-4607 Curbside	4.875"	671489	
		E-4606 Roadside		671488	
12000	(F120) 1970-78	E-4607 Curbside	4.875"	671489	
		E-4606 Roadside		671488	



an **ArvinMeritor™** brand

GMC/CHEVROLET

Titan, Astro, D9K, D9L

King Pin Kits

Axle Rating Lbs.	Axle Code/Year	Part Number/ Bushings Type	King Pin Size	Type	OEM Reference	Notes
9000	(F120D) 1981-82	E-4469B Bronze	1.745" x 9.380"	B	8885621	
12000	(F120) 1979-87 (FF941) 1983-87	E-4469B Bronze	1.745" x 9.380"	B	8885621	
		E-4468B Bronze	1.794" x 10.392"		2010021	
		E-4694C Composite			15510849	
16000	(FL931) 1979-83	E-4458B Bronze	1.999" x 11.212"	B	2036352	
		E-4458C Composite			15585841	
18000	(FL941) 1983-87	E-4458B Bronze	1.999" x 11.212"	B	2036352	
		E-4458C Composite			15585841	

Tie Rod Ends

Axle Rating Lbs.	Axle Code/Year	Part Number/ Location	Stud Center to Rod End	OEM Reference	Notes
12000	(F120) 1979-87	E-4609 Curbside	4.875"	2037140	
		E-4608 Roadside		2037142	
	(FF931) 1979-80	E-4615 Curbside	5.44"	698572	
		E-4614 Roadside		698571	
	(FF931) 1983-87	E-4615 Curbside		698572, 15515805	
		E-4614 Roadside		698571, 15515804	
	(FF941) 1983-86	E-4615 Curbside		698572, 15515805	
		E-4614 Roadside		698571, 15515804	
	(FF971) 1979-83	E-6848 Curbside	10.50"	2055524	
		E-6847 Roadside		2055523	
16000	(FL931) 1979-83	E-4629 Curbside	7.37"	798203	
		E-4628 Roadside		798204	
18000	(FL941) 1983-87	E-4629 Curbside	7.37"	798203	
		E-4628 Roadside		798204	

Drag Links

Axle Rating Lbs.	Axle Code/Year	Part Number	Stud Center to Stud Center	OEM Reference	Notes
12000	(F120) 1979-80	E-6815	16.89"	15501673	
	(F120) 1979-83	E-5374	17.90"	684196	Color coded white.
	(F120) 1984-87	E-6815	16.89"	15501673	w/Ross or Sheppard power steering.
	(FF931) 1983-84	E-5374	17.90"	684196	Color coded white.
	(FF941) 1983-84	E-5374			
	(FF941) 1984-87	E-6815	16.89"	15501673	w/Sheppard power steering.
	(FF971) 1983	E-5374	17.90"	684196	Color coded white.
16000	(FL931) 1979-83	E-5374	17.90"	684196	
	(FL931) 1984-87	E-6815	16.89"	15501673	w/Sheppard power steering - LH.
		E-6817		15501674	w/Sheppard power steering - RH.
18000	(FL941) 1983-84	E-5374	17.90"	684196	Color coded white.
	(FL941) 1984-87	E-6815	16.89"	15501673	w/Sheppard power steering - LH.
		E-6817		15501674	w/Sheppard power steering - RH.

W60, W6N

King Pin Kits

Axle Rating Lbs.	Axle Code/Year	Part Number/ Bushings Type	King Pin Size	Type	OEM Reference	Notes
7000	(F070) 1979-80	E-4443B Bronze	1.249" x 7.888"	A	3927943	
		E-4443N Nylon				
9000	(F090) 1979-80	E-4435B Bronze	8.750"	D	2321013	Tapered pin.
		E-4435N Bronze, Nylon			8885021	

GMC/CHEVROLET
W60, W6N (Continued)

Tie Rod Ends

Axle Rating Lbs.	Axle Code/Year	Part Number/ Location	Stud Center to Rod End	OEM Reference	Notes
7000	(F070) 1979-80	E-4613 Curbside	4.938"	462390	
		E-4612 Roadside		462389	
9000	(F090) 1979-80	E-4609 Curbside	4.875"	2037140	
		E-4608 Roadside		2037142	

W70

King Pin Kits

Axle Rating Lbs.	Axle Code/Year	Part Number/ Bushing Type	King Pin Size	Type	OEM Reference	Notes
9000	(F090) 1970-74	E-4435B Bronze	8.750"	D	2321013	Tapered pin.
		E-4435N Bronze, Nylon			8885021	
12000	(F120) 1970-74	E-4434B Bronze	9.750"	D	2264897	Tapered pin.
		E-4434N Bronze, Nylon				
16000	(FL901) 1971-74	E-4454B Bronze	1.999" x 11.040"	B	2452865	
		E-4454N Nylon				

Tie Rod Ends

Axle Rating Lbs.	Axle Code/Year	Part Number/ Location	Stud Center to Rod End	OEM Reference	Notes
9000	(F090) 1970-74	E-4637 Curbside	3.875"	2330712	w/688568 axle.
		E-4636 Roadside		2330713	
	(F090) 1972-74	E-4609 Curbside	4.875"	2037140	Except 688561; 688568; 2000765, 7, 8; 2002081, 83 axles. Has three piece grease retainer.
		E-4608 Roadside		2037142	
12000	(F120) 1970	E-4607 Curbside	4.875"	671489	Rubber dust boot.
		E-4606 Roadside		671488	
	(F120) 1973-74	E-4609 Curbside		2037140	Except 688561; 688568; 2000765, 7, 8; 2002081, 83 axles. Has three piece grease retainer.
		E-4608 Roadside		2037142	
16000	(FL901) 1971-74	E-4617 Curbside	5.75"	2452860	
		E-4616 Roadside		2451861	

S.O.S.

Special Order Service

Can't find it?

Trouble sourcing products?

Need assistance?

Let Euclid's Special Order Service (S.O.S.) help you find your parts.

Euclid's position as the market leader provides you access to a comprehensive array of truck parts products from the industry's leading manufacturers. Through Euclid, these entire product lines are available to you just by placing a phone call to Euclid's S.O.S. Department at 866-238-2543 (option 2) in the U.S. or 800-387-3889 in Canada.

GMC/CHEVROLET

W70, W7N, W7500

King Pin Kits

Axle Rating Lbs.	Axle Code/Year	Part Number/ Bushing Type	King Pin Size	Type	OEM Reference	Notes
7000	(F070) 1979-80	E-4443B Bronze	1.249" x 7.888"	A	3927943	
		E-4443N Nylon				
9000	(F090) 1970-74	E-4435B Bronze	8.750"	D	2321013	Tapered pin.
		E-4435N Bronze, Nylon			8885021	
	(F090) 1979-80	E-4435B Bronze			2321013	
		E-4435N Bronze, Nylon			8885021	
(F120D) 1975-80	E-4469B Bronze	1.745" x 9.380"	B	8885621		
12000	(F120) 1970-74	E-4434B Bronze	9.750"	D	2264897	Tapered pin.
		E-4434N Bronze, Nylon				
	(F120, F120D) 1975-80	E-4469B Bronze	1.745" x 9.380"	B	8885621	
16000	(FL901) 1971-74	E-4454B Bronze	1.999" x 11.040"	B	2452865	
		E-4454N Nylon				

Tie Rod Ends

Axle Rating Lbs.	Axle Code/Year	Part Number/ Location	Stud Center to Rod End	OEM Reference	Notes
7000	(F070) 1979-80	E-4613 Curbside	4.938"	462390	
		E-4612 Roadside		462389	
9000	(F090) 1970-74	E-4637 Curbside	3.875"	2330712	w/688568 axle.
		E-4636 Roadside		2330713	
	(F090) 1972-74	E-4609 Curbside	4.875"	2037140	Except 688561, 68; 2000765, 67, 68; 2002081, 83 axles. Has three piece grease retainer.
		E-4608 Roadside		2037142	
(F120, F120D) 1979-80	E-4609 Curbside		2037140		
	E-4608 Roadside		2037142		
12000	(F120) 1970	E-4607 Curbside	4.875"	671489	Rubber dust boot.
		E-4606 Roadside		671488	
	(F120) 1973-74	E-4609 Curbside		2037140	Except 688561, 68; 2000765, 67, 68; 2002081, 83 axles. Has three piece grease retainer.
		E-4608 Roadside		2037142	
	(F120) 1979-80	E-4609 Curbside		2037140	
		E-4608 Roadside		2037142	
	(FL901) 1971-74	E-4617 Curbside	5.75"	2452860	
		E-4616 Roadside		2452861	

If you detect any **errors** in this Catalog, please let us know.

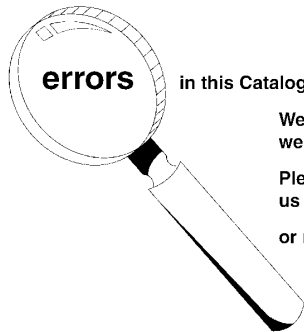

We want the information to be as accurate as possible; we appreciate your help in making it so.

Please e-mail any comments/suggestions/corrections to us at: catalogfeedback@arvinmeritor.com

or mail to: Euclid Industries, LLC
Attn: Catalog Dept.
7975 Dixie Highway
Florence, KY 41042-2754

GMC/CHEVROLET

W80, W8500

King Pin Kits

Axle Rating Lbs.	Axle Code/Year	Part Number/ Bushings Type	King Pin Size	Type	OEM Reference	Notes
7000	1964-65	E-4443B Bronze	1.249" x 7.888"	A	3927943	From 1964, second design.
		E-4443N Nylon				
9000	(F090) 1973-78	E-4435B Bronze	8.750"	D	2321013	Tapered pin.
		E-4435N Bronze, Nylon			8885021	
	1964-65	E-4435B Bronze			2321013	
		E-4435N Bronze, Nylon			8885021	
11000	1964-65	E-4434B Bronze	9.750"	D	2264897	Tapered pin.
		E-4434N Bronze, Nylon				
12000	(F120) 1973-78	E-4434B Bronze	9.750"	D	2264897	Tapered pin.
		E-4434N Bronze, Nylon				

Tie Rod Ends

Axle Rating Lbs.	Axle Code/Year	Part Number/ Location	Stud Center to Rod End	OEM Reference	Notes
7000	1964-65	E-4625 Curbside	6.50"	3864354	
		E-4624 Roadside		3864353	
9000	(F090) 1973-78	E-4609 Curbside	4.875"	2037140	Exc. 688561, 688568; 2000765, 7, 8; 2002081, 83 axles.
		E-4608 Roadside		2037142	
	1964-65	E-4637 Curbside	3.875"	2330712	
		E-4636 Roadside		2330713	
12000	(F120) 1973-78	E-4609 Curbside	4.875"	2037140	Exc. 688561, 688568; 2000765, 7, 8; 2002081, 83 axles.
		E-4608 Roadside		2037142	

W90, W9500

King Pin Kits

Axle Rating Lbs.	Axle Code/Year	Part Number/ Bushings Type	King Pin Size	Type	OEM Reference	Notes
9000	(F090) 1963-72	E-4435B Bronze	8.750"	D	2321013	Tapered pin.
		E-4435N Bronze, Nylon			8885021	
11000	(F110) 1963-72	E-4434B Bronze	9.750"	D	2264897	Tapered pin.
		E-4434N Bronze, Nylon				
12000	(F120) 1963-78	E-4434B Bronze	9.750"	D	2264897	Tapered pin.
		E-4434N Bronze, Nylon				

Tie Rod Ends

Axle Rating Lbs.	Axle Code/Year	Part Number/ Location	Stud Center to Rod End	OEM Reference	Notes
9000	(F090) 1963-69	E-4637 Curbside	3.875"	2330712	
		E-4636 Roadside		2330713	
	(F090) 1970-72	E-4607 Curbside	4.875"	671489	
		E-4606 Roadside		671488	
12000	(F120) 1970-78	E-4607 Curbside	4.875"	671489	
		E-4606 Roadside		671488	

KENWORTH

INDEX

Model	Page No.
C500	11-105
K100	11-106
K300	11-107
L700	11-107
T400	11-109

Model	Page No.
T450	11-109
T600	11-110
T800	11-111
W900	11-112

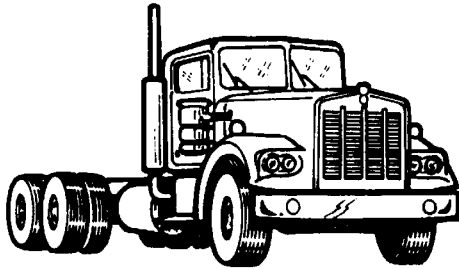

W900

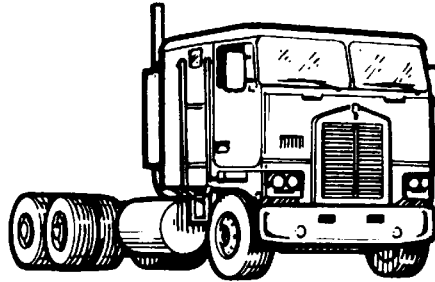

K100

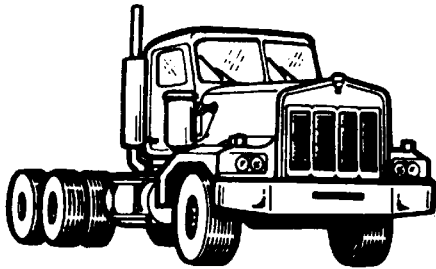

C500

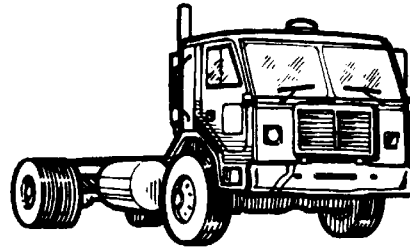

L700

King Pin Kits

Axle Rating Lbs.	Axle Code/Year	Part Number/ Bushing Type	King Pin Size	Type	OEM Reference	Notes
12000	(FE900)	E-4434B Bronze	9.750"	D	KIT 144	Tapered pin.
		E-4434N Bronze, Nylon			KIT 123	
	(FE970)	E-4449B Bronze	1.607" x 8.740"	B	KIT 157	
	(FF901)	E-4442B Bronze	1.794" x 9.120"		KIT 172	
	(FF921)	E-4450B Bronze	1.794" x 10.410"		KIT 193	
	(FF931)	E-4468B Bronze	1.794" x 10.392"		KIT 195	
		E-4694C Composite			KIT 1307	
		E-6199B Bronze				
		E-6199C Composite			R201315	
	(FF971)	E-4595B Bronze	1.607" x 9.375"		KIT 1300	
16000	(FH901)	E-4454B Bronze	1.999" x 11.040"	B	KIT 170	
		E-4454N Nylon			KIT 168	
16000, 18000, 20000	(FL931)	E-4458B Bronze	1.999" x 11.212"	B	KIT 198	
		E-4458C Composite			KIT 1312	
18000	(FL901)	E-4454B Bronze	1.999" x 11.040"	B	KIT 170	
		E-4454N Nylon			KIT 168	
22000	(FL951)	E-4458B Bronze	1.999" x 11.212"	B	KIT 198	
		E-4458C Composite			KIT 1312	

Tie Rod Ends

Axle Rating Lbs.	Axle Code/Year	Part Number/ Location	Stud Center to Rod End	OEM Reference	Notes	
12000	(FE900)	E-4611 Curbside	4.875"	A3144R226		
		E-4610 Roadside		A3144Q225		
		E-4617 Curbside	5.75"	A3144J296		
		E-4616 Roadside		A3144K297		
	(FE970)	E-4611 Curbside	4.875"	A3144R226		
		E-4610 Roadside		A3144Q225		
		E-4617 Curbside	5.75"	A3144J296		
		E-4616 Roadside		A3144K297		
		E-6848 Curbside	10.50"	A3144N534		Will retrofit older axles.
				E-6847 Roadside		
	(FF901)	E-4611 Curbside	4.875"	A3144R226		
		E-4610 Roadside		A3144Q225		
		E-4618 Curbside	5.75"	A3144D238		Anti-tilt seal type.
		E-4619 Roadside		A3144C237		
		E-4617 Curbside		A3144J296		
	E-4616 Roadside	5.44"	A3144K297			
			A3144D524		Greaseable type.	
	E-4614 Roadside	A3144E525				
	(FF971)	E-6848 Curbside	10.50"	A3144N534	Center point steering.	
		E-6847 Roadside		A3144M533		
16000	(FH901)	E-4617 Curbside	5.75"	A3144J296		
		E-4616 Roadside		A3144K297		
16000, 18000, 20000	(FL931)	E-4617 Curbside	5.75"	A3144J296		
		E-4616 Roadside		A3144K297		
		E-4629 Curbside	7.37"	A3144V438		
		E-4628 Roadside		A3144U437		
		E-6856 Curbside	12.688"	A3144D550		
		E-6857 Roadside		A3144C549		

KENWORTH

C500 (Continued)

Tie Rod Ends (Continued)

Axle Rating Lbs.	Axle Code/Year	Part Number/Location	Stud Center to Rod End	OEM Reference	Notes
18000	(FDS1805)	E-4642 Curbside	5.75"	A1-3144F370	After 2/2/83. 1.25" -16 RH thread.
		E-6858 Roadside		A3144E551	After 2/2/83. 1.25" -18 RH thread.
		E-4619 Roadside		A3144C237	Before 2/2/83. 1.25" -12 RH thread.
	(FL901)	E-4617 Curbside		A3144J296	
		E-4616 Roadside		A3144K297	
20000	(FL931)	E-4617 Curbside	5.75"	A3144J296	
		E-4616 Roadside		A3144K297	
		E-4629 Curbside	7.37"	A3144V438	
		E-4628 Roadside		A3144U437	

K100

King Pin Kits

Axle Rating Lbs.	Axle Code/Year	Part Number/Bushing Type	King Pin Size	Type	OEM Reference	Notes
12000	(FE900)	E-4434B Bronze	9.750"	D	KIT 144	Tapered pin.
		E-4434N Bronze, Nylon			KIT 123	
	(FE970)	E-4449B Bronze	1.607" x 8.740"	B	KIT 157	
	(FF921)	E-4442B Bronze	1.794" x 9.120"		KIT 172	
	(FF931)	E-4450B Bronze	1.794" x 10.410"		KIT 193	
	(FF971)	E-4468B Bronze	1.794" x 10.392"		KIT 195	
		E-4694C Composite			KIT 1307	
16000	(FH901)	E-4454B Bronze	1.999" x 11.040"	B	KIT 170	
		E-4454N Nylon			KIT 168	
16000, 18000, 20000	(FL931)	E-4458B Bronze	1.999" x 11.212"	B	KIT 198	
		E-4458C Composite			KIT 1312	
18000	(FL901)	E-4454B Bronze	1.999" x 11.040"	B	KIT 170	
		E-4454N Nylon			KIT 168	

S.O.S.

Special Order Service

Can't find it?

Trouble sourcing products?

Need assistance?

*Let Euclid's Special Order Service (**S.O.S.**) help you find your parts.*

Euclid's position as the market leader provides you access to a comprehensive array of truck parts products from the industry's leading manufacturers. Through Euclid, these entire product lines are available to you just by placing a phone call to Euclid's S.O.S. Department at 866-238-2543 (option 2) in the U.S. or 800-387-3889 in Canada.

KENWORTH
K100 (Continued)
Tie Rod Ends

Axle Rating Lbs.	Axle Code/Year	Part Number/ Location	Stud Center to Rod End	OEM Reference	Notes	
12000	(FE900)	E-4611 Curbside	4.875"	A3144R226		
		E-4610 Roadside		A3144Q225		
		E-4617 Curbside	5.75"	A3144J296		
		E-4616 Roadside		A3144K297		
	(FE970)	E-4611 Curbside	4.875"	A3144R226		
		E-4610 Roadside		A3144Q225		
		E-4617 Curbside	5.75"	A3144J296		
		E-4616 Roadside		A3144K297		
		E-6848 Curbside	10.50"	A3144N534		Will retrofit older axles.
		E-6847 Roadside		A3144M533		
	(FF901)	E-4611 Curbside	4.875"	A3144R226		
		E-4610 Roadside		A3144Q225		
	(FF921)	E-4611 Curbside	5.75"	A3144R226		
		E-4610 Roadside		A3144Q225		
		E-4618 Curbside		A3144D238		Anti-tilt seal type.
		E-4619 Roadside		A3144C237		
		E-4617 Curbside		A3144J296		
	E-4616 Roadside	A3144K297				
	(FF921), (FF931)	E-4615 Curbside	5.44"	A3144D524		Greaseable type.
		E-4614 Roadside		A3144E525		
(FF971)	E-6848 Curbside	10.50"	A3144N534	Center point steering.		
	E-6847 Roadside		A3144M533			
16000	(FH901)	E-4617 Curbside	5.75"	A3144J296		
		E-4616 Roadside		A3144K297		
16000, 18000, 20000	(FL931)	E-4617 Curbside	5.75"	A3144J296		
		E-4616 Roadside		A3144K297		
		E-4629 Curbside	7.37"	A3144F448		
		E-4628 Roadside		A3144G449		
		E-6856 Curbside	12.688"	A3144D550		
		E-6857 Roadside		A3144C549		
18000	(FL901)	E-4617 Curbside	5.75"	A3144J296		
		E-4616 Roadside		A3144K297		

Drag Links

Axle Rating Lbs.	Axle Code/Year	Part Number	Stud Center to Stud Center	OEM Reference	Notes
All	All	E-4628	7.37" Stud center to rod end	L28SV5203A1	Drag link end. Has LH thread.
		E-4629		L28SV5202A1	Drag link end. Has RH thread.

K300

Tie Rod Ends

Axle Rating Lbs.	Axle Code/Year	Part Number/ Location	Stud Center to Rod End	OEM Reference	Notes	
12000	E12001	E-10137 Curbside	6.00"	817019		
		E-10138 Roadside		817018		
	EFA-12F4	E-4615 Curbside	5.44"	1006149		Greaseable type.
		E-4614 Roadside		1006148		
		E-8758 Curbside	8.125"	1009010		
		E-8757 Roadside		1009009		

KENWORTH

L700

King Pin Kits

Axle Rating Lbs.	Axle Code/Year	Part Number/ Bushing Type	King Pin Size	Type	OEM Reference	Notes
12000	(FE900)	E-4434B Bronze	9.750"	D	KIT 144	Tapered pin.
		E-4434N Bronze, Nylon			KIT 123	
	(FE970)	E-4449B Bronze	1.607" x 8.740"	B	KIT 157	
	(FF901)	E-4442B Bronze	1.794" x 9.120"		KIT 172	
	(FF921)	E-4450B Bronze	1.794" x 10.410"		KIT 193	
	(FF931)	E-4468B Bronze	1.794" x 10.392"		KIT 195	
		E-4694C Composite			KIT 1307	
	(FF971)	E-4595B Bronze	1.607" x 9.375"		KIT 1300	
16000	(FH901)	E-4454B Bronze	1.999" x 11.040"	B	KIT 170	
		E-4454N Nylon			KIT 168	
16000, 18000, 20000	(FL931)	E-4458B Bronze	1.999" x 11.212"	B	KIT 198	
		E-4458C Composite			KIT 1312	
18000	(FL901)	E-4454B Bronze	1.999" x 11.040"	B	KIT 170	
		E-4454N Nylon			KIT 168	

Tie Rod Ends

Axle Rating Lbs.	Axle Code/Year	Part Number/ Location	Stud Center to Rod End	OEM Reference	Notes	
12000	(FE900)	E-4611 Curbside	4.875"	A3144R226		
		E-4610 Roadside		A3144Q225		
		E-4617 Curbside	5.75"	A3144J296		
		E-4616 Roadside		A3144K297		
	(FE970)	E-4611 Curbside	4.875"	A3144R226		
		E-4610 Roadside		A3144Q225		
		E-4617 Curbside	5.75"	A3144J296		
		E-4616 Roadside		A3144K297		
		E-6848 Curbside	10.50"	A3144N534		Will retrofit older axles.
		E-6847 Roadside		A3144M533		
	(FF901)	E-4611 Curbside	4.875"	A3144R226		
		E-4610 Roadside		A3144Q225		
		E-4618 Curbside	5.75"	A3144D238		Anti-tilt seal type.
		E-4619 Roadside		A3144C237		
		E-4617 Curbside		A3144J296		
	(FF921), (FF931)	E-4615 Curbside	5.44"	A3144D524	Greaseable type.	
		E-4614 Roadside		A3144E525		
	(FF971)	E-6848 Curbside	10.50"	A3144N534	Center point steering.	
E-6847 Roadside		A3144M533				
16000	(FH901)	E-4617 Curbside	5.75"	A3144J296		
		E-4616 Roadside		A3144K297		
16000, 18000, 20000	(FL931)	E-4617 Curbside	5.75"	A3144J296		
		E-4616 Roadside		A3144K297		
		E-4629 Curbside	7.37"	A3144F448		
		E-4628 Roadside		A3144G449		
18000	(FL901)	E-4617 Curbside	5.75"	A3144J296		
		E-4616 Roadside		A3144K297		

King Pin Kits

Axle Rating Lbs.	Axle Code/Year	Part Number/ Bushings Type	King Pin Size	Type	OEM Reference	Notes
10000	(FD961)	E-6199B Bronze	1.794" x 10.392"	B	KIT 1315	Uses 1 drawkey 3.68" long and 1 drawkey 3.25" long.
		E-6199C Composite				
12000	(FF941)	E-4468B Bronze	1.794" x 10.392"	B	KIT 195	Uses 1 drawkey 3.68" long and 1 drawkey 3.25" long.
		E-4694C Composite			KIT 1307	
	(FF961)	E-6199B Bronze			KIT 1315	
	E-6199C Composite					
12000, 13000	EFA-12F4, EFA-13F5	E-4696B Bronze	1.625" x 9.195"	A	806355	
		E-4696C Composite				
14600	(FG941)	E-4695C Composite	1.794" x 10.392"	B	KIT 1309	
		E-6868B Bronze			KIT 1310	

Tie Rod Ends

Axle Rating Lbs.	Axle Code/Year	Part Number/ Location	Stud Center to Rod End	OEM Reference	Notes
10000	(FD961)	E-4615 Curbside	5.44"	A3144D524	Greaseable type.
		E-4614 Roadside		A3144E525	
12000	(FF941), (FF961)	E-4615 Curbside	5.44"	A3144D524	Greaseable type.
		E-4614 Roadside		A3144E525	
	E1200I	E-10137 Curbside	6.00"	817019	
		E-10138 Roadside		817018	
12000, 13000	EFA-12F3, EFA-13F3, EFA-12F4, EFA-13F5	E-4615 Curbside	5.44"	1006149	Greaseable type.
		E-4614 Roadside		1006148	
		E-8758 Curbside	8.125"	1009010	
				E-8757 Roadside	
14600	(FG941)	E-4615 Curbside	5.44"	A3144D524	Greaseable type.
		E-4614 Roadside		A3144E525	

Drag Links

Axle Rating Lbs.	Axle Code/Year	Part Number	Stud Center to Stud Center	OEM Reference	Notes
All	All	E-6825	28.28"	L24VU8008A11	Non-replaceable ends.

King Pin Kits

Axle Rating Lbs.	Axle Code/Year	Part Number/ Bushings Type	King Pin Size	Type	OEM Reference	Notes
10000	(FD961)	E-6199B Bronze	1.794" x 10.392"	B	KIT 1315	Uses 1 drawkey 3.68" long and 1 drawkey 3.25" long.
		E-6199C Composite				
12000	(FF941)	E-4468B Bronze	1.794" x 10.392"	B	KIT 195	Uses 1 drawkey 3.68" long and 1 drawkey 3.25" long.
		E-4694C Composite			KIT 1307	
	(FF961)	E-6199B Bronze			KIT 1315	
	E-6199C Composite					
12000, 13000	EFA-12F4, EFA-13F5	E-4696B Bronze	1.625" x 9.195"	A	806355	
		E-4696C Composite				
14600	(FG941)	E-4695C Composite	1.794" x 10.392"	B	KIT 1309	
		E-6868B Bronze			KIT 1310	
16000, 18000, 20000	(FL941), (FL943)	E-4458B Bronze	1.999" x 11.212"	B	KIT 198	
		E-4458C Composite			KIT 1312	

KENWORTH

T450 (Continued)

Tie Rod Ends

Axle Rating Lbs.	Axle Code/Year	Part Number/ Location	Stud Center to Rod End	OEM Reference	Notes
10000	(FD961)	E-4615 Curbside	5.44"	A3144D524	Greaseable type.
		E-4614 Roadside		A3144E525	
12000	(FF941), (FF943), (FF961)	E-4615 Curbside	5.44"	A3144D524	Greaseable type.
		E-4614 Roadside		A3144E525	
	E1200I	E-10137 Curbside	6.00"	817019	
		E-10138 Roadside		817018	
12000, 13000	EFA-12F3, EFA-13F3, EFA-12F4, EFA-13F5	E-4615 Curbside	5.44"	1006149	Greaseable type.
		E-4614 Roadside		1006148	
		E-8758 Curbside	8.125"	1009010	
				E-8757 Roadside	
14600	(FG941)	E-4615 Curbside	5.44"	A3144D524	Greaseable type.
		E-4614 Roadside		A3144E525	
16000, 18000, 20000	(FL941), (FL943)	E-4617 Curbside	5.75"	A3144J296	
		E-4616 Roadside		A3144K297	
		E-4629 Curbside	7.37"	A3144F448	
		E-4628 Roadside		A3144G449	
		E-6856 Curbside	12.688"	A3144D550	
				E-6857 Roadside	

Drag Links

Axle Rating Lbs.	Axle Code/Year	Part Number	Stud Center to Stud Center	OEM Reference	Notes
All	All	E-6825	28.28"	L24VU8008A11	Non-replaceable ends.

T600

King Pin Kits

Axle Rating Lbs.	Axle Code/Year	Part Number/ Bushing Type	King Pin Size	Type	OEM Reference	Notes
12000	(FF941), (FF943)	E-4468B Bronze	1.794" x 10.392"	B	KIT 195	Uses 1 drawkey 3.68" long and 1 drawkey 3.25" long.
		E-4694C Composite			KIT 1307	
	(FF961)	E-6199B Bronze			KIT 1315	
		E-6199C Composite				
12000, 13000	EFA-12F4, EFA-13F5	E-4696B Bronze	1.625" x 9.195"	A	806355	
		E-4696C Composite				
14600	(FG941)	E-4695C Composite	1.794" x 10.392"	B	KIT 1309	
		E-6868B Bronze			KIT 1310	

Tie Rod Ends

Axle Rating Lbs.	Axle Code/Year	Part Number/ Location	Stud Center to Rod End	OEM Reference	Notes
12000	(FF941), (FF943), (FF961)	E-4615 Curbside	5.44"	A3144D524	Greaseable type.
		E-4614 Roadside		A3144E525	
	E1200I	E-10137 Curbside	6.00"	817019	
		E-10138 Roadside		817018	
12000, 13000	EFA-12F3, EFA-13F3, EFA-12F4, EFA-13F5	E-4615 Curbside	5.44"	1006149	Greaseable type.
		E-4614 Roadside		1006148	
		E-8758 Curbside	8.125"	1009010	
				E-8757 Roadside	
14600	(FG941)	E-4615 Curbside	5.44"	A3144D524	Greaseable type.
		E-4614 Roadside		A3144E525	

Drag Links

Axle Rating Lbs.	Axle Code/Year	Part Number	Stud Center to Stud Center	OEM Reference	Notes
All	All	E-6825	28.28"	L24VU8008A11	Non-replaceable ends.

T800

King Pin Kits

Axle Rating Lbs.	Axle Code/Year	Part Number/ Bushings Type	King Pin Size	Type	OEM Reference	Notes
12000	(FF941)	E-4468B Bronze	1.794" x 10.392"	B	KIT 195	Uses 1 drawkey 3.68" long and 1 drawkey 3.25" long.
		E-4694C Composite			KIT 1307	
	(FF961)	E-6199B Bronze			KIT 1315	
		E-6199C Composite				
12000, 13000	EFA-12F4, EFA-13F5	E-4696B Bronze E-4696C Composite	1.625" x 9.195"	A	806355	
14600	(FG941)	E-4695C Composite	1.794" x 10.392"	B	KIT 1309	
		E-6868B Bronze			KIT 1310	
16000, 18000, 20000	(FL941), (FL943)	E-4458B Bronze	1.999" x 11.212"	B	KIT 198	
		E-4458C Composite			KIT 1312	

Tie Rod Ends

Axle Rating Lbs.	Axle Code/Year	Part Number/ Location	Stud Center to Rod End	OEM Reference	Notes
12000	(FF941), (FF943), (FF961)	E-4615 Curbside	5.44"	A3144D524	Greaseable type.
		E-4614 Roadside		A3144E525	
	E1200I	E-10137 Curbside	6.00"	817019	
		E-10138 Roadside		817018	
12000, 13000	EFA-12F3, EFA-13F3, EFA-12F4, EFA-13F5	E-4615 Curbside	5.44"	1006149	Greaseable type.
		E-4614 Roadside		1006148	
		E-8758 Curbside	8.125"	1009010	
				E-8757 Roadside	
14600	(FG941)	E-4615 Curbside	5.44"	A3144D524	Greaseable type.
		E-4614 Roadside		A3144E525	
16000, 18000, 20000	(FL941), (FL943)	E-4617 Curbside	5.75"	A3144J296	
		E-4616 Roadside		A3144K297	
		E-4629 Curbside	7.37"	A3144F448	
		E-4628 Roadside		A3144G449	
		E-6856 Curbside	12.688"	A3144D550	
		E-6857 Roadside		A3144C549	

Drag Links

Axle Rating Lbs.	Axle Code/Year	Part Number	Stud Center to Stud Center	OEM Reference	Notes
All	All	E-6825	28.28"	L24VU8008A11	Non-replaceable ends.
		E-4629	7.37" Stud center to rod end	A3144V438	End only. Use with E-8732.
		E-8732	28.25"	K162-536	Uses E-4629 replaceable end.



an **ArvinMeritor**™ brand

KENWORTH

W900

King Pin Kits

Axle Rating Lbs.	Axle Code/Year	Part Number/ Bushing Type	King Pin Size	Type	OEM Reference	Notes
12000	(FE900)	E-4434B Bronze	9.750"	D		Tapered pin.
		E-4434N Bronze, Nylon				
	(FE970)	E-4449B Bronze	1.607" x 8.740"	B	KIT 157	
	(FF901)	E-4442B Bronze	1.794" x 9.120"		KIT 172	
	(FF921)	E-4450B Bronze	1.794" x 10.410"		KIT 193	
	(FF931), (FF941)	E-4468B Bronze	1.794" x 10.392"		KIT 195	
		E-4694C Composite			KIT 1307	
(FF971)	E-4595B Bronze	1.607" x 9.375"	KIT 1300			
12000, 13000	EFA-12F4, EFA-13F5	E-4696B Bronze	1.625" x 9.195"	A		
		E-4696C Composite			806355	
14600	(FG941)	E-4695C Composite	1.794" x 10.392"	B	KIT 1309	
		E-6868B Bronze			KIT 1310	
16000	(FH901)	E-4454B Bronze	1.999" x 11.040"	B	KIT 170	
		E-4454N Nylon			KIT 168	
16000, 18000, 20000	(FL931), (FL941)	E-4458B Bronze	1.999" x 11.212"	B	KIT 198	
		E-4458C Composite			KIT 1312	
18000	(FL901)	E-4454B Bronze	1.999" x 11.040"	B	KIT 170	
		E-4454N Nylon			KIT 168	
18000, 20000, 22000	EFA-18F3, EFA-20F4	E-6194B Bronze	1.873" x 9.965"	A	1008500	
		E-6194C Composite				

Tie Rod Ends

Axle Rating Lbs.	Axle Code/Year	Part Number/ Location	Stud Center to Rod End	OEM Reference	Notes	
12000	(FE900)	E-4611 Curbside	4.875"	A3144R226		
		E-4610 Roadside		A3144Q225		
		E-4617 Curbside	5.75"	A3144J296		
		E-4616 Roadside		A3144K297		
	(FE970)			4.875"	A3144R226	
		E-4610 Roadside			A3144Q225	
		E-4617 Curbside	5.75"		A3144J296	
		E-4616 Roadside			A3144K297	
		E-6848 Curbside	10.50"	A3144N534	Will retrofit older axles.	
		E-6847 Roadside		A3144M533		
	(FF901)			4.875"	A3144R226	
		E-4610 Roadside			L28SV5052A1	
		E-4618 Curbside	5.75"	A3144D238	Anti-tilt seal type.	
		E-4619 Roadside		A3144C237		
		E-4617 Curbside		A3144J296		
		E-4616 Roadside		A3144K297		
(FF921), (FF931), (FF941)	E-4615 Curbside	5.44"	A3144D524	Greaseable type.		
	E-4614 Roadside		A3144E525			
(FF971)	E-6848 Curbside	10.50"	A3144N534	Center point steering.		
	E-6847 Roadside		A3144M533			
12000, 13200	EFA-12F4, EFA-13F5	E-4615 Curbside	5.44"	1006149		
		E-4614 Roadside		1006148		
		E-8758 Curbside	8.125"	1009010		
		E-8757 Roadside		1009009		
16000	(FH901)	E-4617 Curbside	5.75"	A3144J296		
		E-4616 Roadside		A3144K297		
16000, 18000, 20000	(FL931)	E-4617 Curbside	5.75"	A3144J296		
		E-4616 Roadside		A3144K297		

Axle Rating Lbs.	Axle Code/Year	Part Number/ Location	Stud Center to Rod End	OEM Reference	Notes
18000	(FL901)	E-4617 Curbside	5.75"	A3144J296	
		E-4616 Roadside		A3144K297	
	(FL931)	E-4629 Curbside	7.37"	A3144F448	
		E-4628 Roadside		A3144G449	
18000, 20000, 22000	EFA-18F3, EFA-20F4	E-4629 Curbside	7.37"	820627, 820695	
		E-4628 Roadside		820626, 820694	

Drag Links

Axle Rating Lbs.	Axle Code/Year	Part Number	Stud Center to Stud Center	OEM Reference	Notes
All	(All)	E-9877	5.75" Stud center to rod end		Drag link end used on E-5379.
		E-4629	7.37" Stud center to rod end	L28SV5202A1	Drag link end used on E-5378 and E-5380.
12000, 16000, 18000	(All)	E-5378	29.56"	K162-280	
		E-5379		K162-311	
		E-5380	30.56"	K162-363	

FLEET VEHICLE MAINTENANCE COMPONENTS

The Euclid Brand offers "All-Makes" Aftermarket Maintenance Components for these Vehicle Systems:

BRAKE PRODUCTS

- Euclid New Lined Brake Shoes
- Euclid Relined Brake Shoes
- Euclid Friction Materials
- Camshafts
- Air Drum Brake Components & Kits
- Air Disc Pads & Components
- Hydraulic Disc Pads
- Hydraulic Drum & Disc Brake Components
- Automatic & Manual Slack Adjusters
- Brake & Camshaft Repair Kits

WHEEL END PRODUCTS

- Cast Brake Drums
- X-30 Steellite Brake Drums
- Hubs & Spoke Wheels
- Rotors - Hydraulic Disc
- Wheel Attaching Components
- Seals & Bearings

DRIVELINE PRODUCTS

- Universal Joints - US only
- Center Bearings - US only
- Miscellaneous Hardware - US only

AIR SYSTEM PRODUCTS

- Air Dryers & Cartridges
- Air Valves - New & Reman
- Reman Air Compressors
- Air Brake Hose & Fittings

TRAILER PRODUCTS

- Axle Tubes
- "Dressed" Axles

FRONT AXLE PRODUCTS

- King Pin Kits
- Tie Rod & Drag Link Ends
- Drag Links

SUSPENSION PRODUCTS

- Air Springs
- Equalizers, Hangers, Beams
- Bushings & Hardware
- Speciality Polyurethane Components
- Torque Rods
- U-Bolts
- Gabriel® Shock Absorbers

AIR CONDITIONING & HEATING PRODUCTS

- Compressors
- Clutches
- Blower Motors
- Receiver Driers
- Valves, Switches
- Condensor, Evaporator, Heater Cores
- Tools
- Chemicals, Lubricants
- Refrigerants

ELECTRICAL & WATER PUMPS

- Alternators
- Starters
- Electrical Parts & Accessories
- Water Pumps
- Fan Clutches Rebuilt Kits

OTHER PRODUCTS

- Ankra Cargo Restraint Systems

INDEX

Model	Page No.	Model	Page No.
B53, B57	11-115	R600, R685R, R685ST, R686ST	11-122
DM400, MB400, MB600	11-115	R600L, R600LS, R700L, R700LS, RWL700S,	
DM600, DM606S, DM607S, DM685S, DM685T	11-116	RWS700S, WL700L, W700LS, WS700L,	
DM800	11-117	WS700LS	11-123
DMM600, RD700	11-118	RD400	11-124
MC400, MR400, MC600, MR600	11-119	RD600, R700	11-125
R400	11-121	U600, U68ST, F700, F786ST, R767ST	11-127

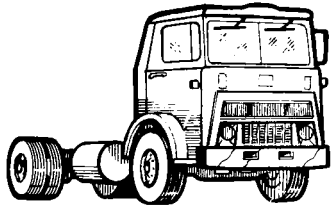

MB SERIES

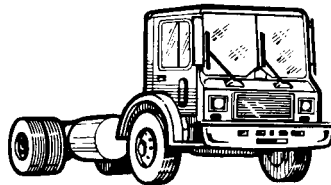

MC & MR SERIES

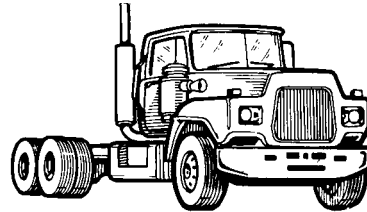

R SERIES

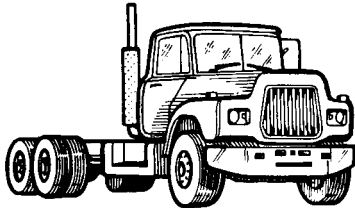

U SERIES

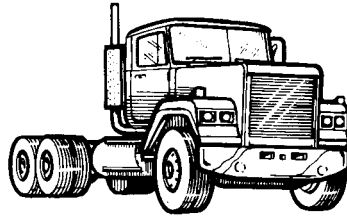

**VALUE-LINER &
SUPER LINER**

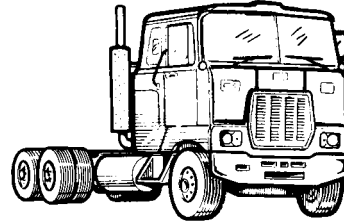

**CRUISE-LINER &
F SERIES**

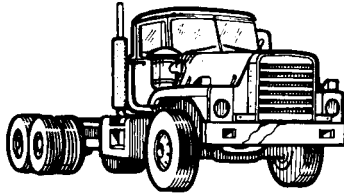

DM SERIES

King Pin Kits

Axle Rating Lbs.	Axle Code/Year	Part Number/ Bushing Type	King Pin Size	Type	OEM Reference	Notes
18000	FA604 (FL901)	E-4454B Bronze	1.999" x 11.040"	B	301SQ44	
		E-4454N Nylon				

Tie Rod Ends

Axle Rating Lbs.	Axle Code/Year	Part Number/ Location	Stud Center to Rod End	OEM Reference	Notes
18000	FA604 (FL901)	E-9878 Curbside	5.75"		Side zerk.
		E-9877 Roadside			
		E-4617 Curbside		10QH39P1	
		E-4616 Roadside		10QH310P1	

DM400, MB400, MB600

King Pin Kits

Axle Rating Lbs.	Axle Code/Year	Part Number/ Bushing Type	King Pin Size	Type	OEM Reference	Notes
10500	FA532, FA(W)536	E-4467B Bronze	7.470"	E	301SQ47CP1	Tapered pin.
12000	FA(W)537	E-4467B Bronze	7.470"	E	301SQ47CP1	Tapered pin.
18000	FA(W)616	E-4599B Bronze	8.750"	E	301SQ52	Tapered pin.
20000	FA(W)617	E-4599B Bronze	8.750"	E	301SQ52	Tapered pin.

Tie Rod Ends

Axle Rating Lbs.	Axle Code/Year	Part Number/ Location	Stud Center to Rod End	OEM Reference	Notes		
10500	FA(W)536	E-4611 Curbside	4.875"	10QH242P1	Coarse thread.		
		E-4610 Roadside		10QH243P2			
		E-4640 Curbside		10QH243P1	Fine thread.		
				E-9878 Curbside	5.75"		Side zerk.
				E-9877 Roadside			
				E-4617 Curbside		10QH39P1	
				E-4616 Roadside		10QH310P1	
12000	FA(W)537	E-4607 Curbside	4.875"	10QH38			
		E-9878 Curbside	5.75"		Side zerk.		
E-9877 Roadside							
E-4617 Curbside	10QH39P1						
E-4616 Roadside	10QH310P1						
18000	FA(W)616	E-9878 Curbside	5.75"		Side zerk.		
		E-9877 Roadside					
		E-4617 Curbside		10QH39P1	Use with tube 7QH253P1, 7QH253P2.		
		E-4616 Roadside	10QH310P1				
		E-4629 Curbside	7.37"	10QH311P1	Use with tube 7QH253P3, 7QH253P4.		
		E-4628 Roadside		10QH312P1	Bottom zerk.		
		E-9879 Curbside		10QH311P1	Use with tube 7QH253P3, 7QH253P4.		
E-9880 Roadside	10QH312P1	Side zerk.					
20000	FA(W)617	E-9878 Curbside	5.75"		Side zerk.		
		E-9877 Roadside					
		E-4617 Curbside		10QH39P1	Use with tube 7QH253P1, 7QH253P2.		
		E-4616 Roadside	10QH310P1				
		E-4629 Curbside	7.37"	10QH311P1	Use with tube 7QH253P3, 7QH253P4.		
		E-4628 Roadside		10QH312P1	Bottom zerk.		
		E-9879 Curbside		10QH311P1	Use with tube 7QH253P3, 7QH253P4.		
E-9880 Roadside	10QH312P1	Side zerk.					

MACK

DM400, MB400, MB600 (Continued)

Drag Links

Axle Rating Lbs.	Axle Code/Year	Part Number	Stud Center to Stud Center	OEM Reference	Notes
All	All	E-10114	2.75" Stud center to rod end	37QC34A	Power steering cylinder end.
		E-9881	5.75" Stud center to rod end	18QK201	Pinch bolt socket used on drag links with tight clearance.
12000	FA(W)537	E-9877	5.75" Stud center to rod end	18QK23A	Drag link end socket - RH thread.
		E-9877		18QK29301	Drag link end socket - RH thread. Use w/tube stamped 39305.
		E-9878		18QK28A	Drag link end socket - LH thread.
18000	FA(W)616	E-9877	5.75" Stud center to rod end	18QK23A	Drag link end socket - RH thread.
		E-9877		18QK29301	Drag link end socket - RH thread. Use w/tube stamped 39305.
		E-9878		18QK28A	Drag link end socket - LH thread.
20000	FA(W)617	E-9877	5.75" Stud center to rod end	18QK23A	Drag link end socket - RH thread.
		E-9877		18QK29301	Drag link end socket - RH thread. Use w/tube stamped 39305.
		E-9878		18QK28A	Drag link end socket - LH thread.

DM600, DM606S, DM607S, DM685S, DM685T

King Pin Kits

Axle Rating Lbs.	Axle Code/Year	Part Number/ Bushing Type	King Pin Size	Type	OEM Reference	Notes
10500	FA532, FA(W)536	E-4467B Bronze	7.470"	E	301SQ47CP1	Tapered pin.
12000	FA(W)537, FA(W)537C	E-4467B Bronze	7.470"	E	301SQ47CP1	Tapered pin.
18000	FA(W)616	E-4599B Bronze	8.750"	E	301SQ52	Tapered pin.
20000	FA(W)617	E-4599B Bronze	8.750"	E	301SQ52	Tapered pin.

Tie Rod Ends

Axle Rating Lbs.	Axle Code/Year	Part Number/ Location	Stud Center to Rod End	OEM Reference	Notes		
10500	FA(W)536	E-4611 Curbside	4.875"	10QH242P1	Coarse thread.		
		E-4610 Roadside		10QH243P2			
		E-4640 Curbside		10QH243P1	Fine thread.		
				E-9878 Curbside	5.75"		Side zerk.
				E-9877 Roadside			
				E-4617 Curbside		10QH39P1	
				E-4616 Roadside		10QH310P1	
12000	FA(W)537, FA(W)537C	E-4607 Curbside	5.75"	10QH38	Side zerk.		
		E-9878 Curbside					
		E-9877 Roadside					
		E-4617 Curbside		10QH39P1			
18000	FA(W)616	E-4616 Roadside	7.37"	10QH310P1	Side zerk.		
		E-9878 Curbside					
		E-9877 Roadside					
		E-4617 Curbside		10QH39P1	Use with tube 7QH253P1, 7QH253P2.		
		E-4616 Roadside		10QH310P1	For units built before 2/20/84.		
		E-4629 Curbside		10QH311P1	Use with tube 7QH253P3, 7QH253P4.		
		E-4628 Roadside		10QH312P1	For units built after 2/20/84.		
		E-9879 Curbside		10QH311P1	Use with tube 7QH253P3, 7QH253P4.		
E-9880 Roadside	10QH312P1	For units built after 2/20/84. Side zerk.					

DM600, DM606S, DM607S, DM685S, DM685T (Continued)

Tie Rod Ends (Continued)

Axle Rating Lbs.	Axle Code/Year	Part Number/ Location	Stud Center to Rod End	OEM Reference	Notes
20000	FA(W)617	E-4629 Curbside	7.37"	10QH311P1	Use with tube 7QH253P3, 7QH253P4.
		E-4628 Roadside		10QH312P1	
		E-9879 Curbside		10QH311P1	Use with tube 7QH253P3, 7QH253P4. Side zerk.
		E-9880 Roadside		10QH312P1	
	FA(W)617, FA(W)617D	E-9878 Curbside	5.75"		Side zerk.
		E-9877 Roadside			
		E-4617 Curbside		10QH39P1	Use with tube 7QH253P1, 7QH253P2.
		E-4616 Roadside		10QH310P1	

Drag Links

Axle Rating Lbs.	Axle Code/Year	Part Number	Stud Center to Stud Center	OEM Reference	Notes
All	All	E-10114	2.75" Stud center to rod end	37QC34A	Power steering cylinder end.
		E-9881	5.75" Stud center to rod end	18QK201	Pinch bolt socket used on drag links with tight clearance.
10500	FA(W)536	E-9877	5.75" Stud center to rod end	18QK29301	Drag link end socket - RH thread. Use w/tube stamped 39305.
		E-9877		18QK23A	Drag link end socket - RH thread.
		E-9878		18QK28A	Drag link end socket - LH thread.
12000	FA(W)537	E-9877	5.75" Stud center to rod end	18QK29301	Drag link end socket - RH thread. Use w/tube stamped 39305.
		E-9877		18QK23A	Drag link end socket - RH thread.
		E-9878		18QK28A	Drag link end socket - LH thread.
18000	FA(W)616	E-9877	5.75" Stud center to rod end	18QK29301	Drag link end socket - RH thread. Use w/tube stamped 39305.
		E-9877		18QK23A	Drag link end socket - RH thread.
		E-9878		18QK28A	Drag link end socket - LH thread.
20000	FA(W)617	E-9877	5.75" Stud center to rod end	18QK23A	Drag link end socket - RH thread.
		E-9877		18QK29301	Drag link end socket - RH thread. Use w/tube stamped 39305.
		E-9878		18QK28A	Drag link end socket - LH thread.

DM800

King Pin Kits

Axle Rating Lbs.	Axle Code/Year	Part Number/ Bushing Type	King Pin Size	Type	OEM Reference	Notes
18000	FA(W)616	E-4599B Bronze	8.750"	E	301SQ52	Tapered pin.
20000	FA(W)617	E-4599B Bronze	8.750"	E	301SQ52	Tapered pin.

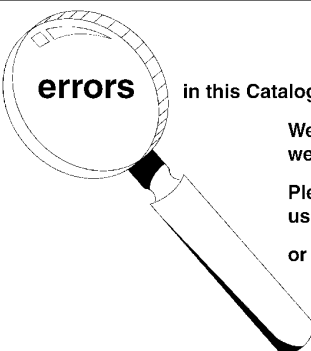

If you detect any **errors** in this Catalog, please let us know.

We want the information to be as accurate as possible; we appreciate your help in making it so.

Please e-mail any comments/suggestions/corrections to us at: catalogfeedback@arvinmeritor.com

or mail to: **Euclid Industries, LLC**
Attn: Catalog Dept.
7975 Dixie Highway
Florence, KY 41042-2754

MACK

DM800 (Continued)

Tie Rod Ends

Axle Rating Lbs.	Axle Code/Year	Part Number/ Location	Stud Center to Rod End	OEM Reference	Notes	
18000	FA(W)616	E-9878 Curbside	5.75"		Side zerk.	
		E-9877 Roadside				
		E-4617 Curbside			10QH39P1	Use with tube 7QH2531P1, 7QH253P2.
		E-4616 Roadside			10QH310P1	
		E-4629 Curbside	7.37"	10QH311P1	Use with tube 7QH253P3, 7QH253P4.	
		E-4628 Roadside		10QH312P1		
		E-9879 Curbside		10QH311P1	Use with tube 7QH253P3, 7QH253P4.	
		E-9880 Roadside		10QH312P1		Side zerk.
20000	FA(W)617	E-9878 Curbside	5.75"		Side zerk.	
		E-9877 Roadside				
		E-4617 Curbside			10QH39P1	Use with tube 7QH2531P1, 7QH253P2. For units built before 2/20/84.
		E-4616 Roadside			10QH310P1	
		E-4629 Curbside	7.37"	10QH311P1	Use with tube 7QH253P3, 7QH253P4. For units built after 2/20/84.	
		E-4628 Roadside		10QH312P1		
		E-9879 Curbside		10QH311P1	Use with tube 7QH253P3, 7QH253P4.	
		E-9880 Roadside		10QH312P1		For units built after 2/20/84. Side zerk.

Drag Links

Axle Rating Lbs.	Axle Code/Year	Part Number	Stud Center to Stud Center	OEM Reference	Notes
All	All	E-10114	2.75" Stud center to rod end	37QC34A	Power steering cylinder end.
		E-9881	5.75" Stud center to rod end	18QK201	Pinch bolt socket used on drag links with tight clearance.
18000	FA616	E-9877	5.75" Stud center to rod end	18QK23A	Drag link end socket - RH thread.
		E-9877		18QK29301	Drag link end socket - RH thread. Use w/tube stamped 39305.
		E-9878		18QK28A	Drag link end socket - LH thread.
20000	FA617	E-9877	5.75" Stud center to rod end	18QK23A	Drag link end socket - RH thread.
		E-9877		18QK29301	Drag link end socket - RH thread. Use w/tube stamped 39305.
		E-9878		18QK28A	Drag link end socket - LH thread.

DMM600, RD700

King Pin Kits

Axle Rating Lbs.	Axle Code/Year	Part Number/ Bushing Type	King Pin Size	Type	OEM Reference	Notes
10500	FA532, FA(W)536	E-4467B Bronze	7.470"	E	301SQ47CP1	Tapered pin.
12000	FA(W)537	E-4467B Bronze	7.470"	E	301SQ47CP1	Tapered pin.
18000	FA(W)616	E-4599B Bronze	8.750"	E	301SQ52	Tapered pin.
20000	FA(W)617	E-4599B Bronze	8.750"	E	301SQ52	Tapered pin.



an **ArvinMeritor**™ brand

DMM600, RD700 (Continued)

Tie Rod Ends

Axle Rating Lbs.	Axle Code/Year	Part Number/ Location	Stud Center to Rod End	OEM Reference	Notes		
10500	FA(W)536	E-4611 Curbside	4.875"	10QH242P1	Coarse thread.		
		E-4610 Roadside		10QH243P2			
		E-4640 Curbside		10QH243P1	Fine thread.		
				E-9878 Curbside	5.75"		Side zerk.
				E-9877 Roadside			
				E-4617 Curbside		10QH39P1	
				E-4616 Roadside		10QH310P1	
FA532	E-4607 Curbside			4.875"		10QH38	
12000	FA(W)537	E-9878 Curbside	5.75"		Side zerk.		
		E-9877 Roadside					
		E-4617 Curbside		10QH39P1			
		E-4616 Roadside		10QH310P1			
18000	FA(W)616	E-9878 Curbside	5.75"		Side zerk.		
		E-9877 Roadside					
		E-4617 Curbside		10QH39P1	Use with tube 7QH253P1, 7QH253P2.		
		E-4616 Roadside		10QH310P1			
				E-4629 Curbside	7.37"	10QH311P1	Use with tube 7QH253P3, 7QH253P4.
				E-4628 Roadside		10QH312P1	
				E-9879 Curbside		10QH311P1	Use with tube 7QH253P3, 7QH253P4.
				E-9880 Roadside		10QH312P1	Side zerk.
20000	FA(W)617	E-9878 Curbside	5.75"		Side zerk.		
		E-9877 Roadside					
				E-4629 Curbside	7.37"	10QH311P1	Use with tube 7QH253P3, 7QH253P4.
				E-4628 Roadside		10QH312P1	
				E-9879 Curbside		10QH311P1	Use with tube 7QH253P3, 7QH253P4.
				E-9880 Roadside		10QH312P1	Side zerk.
		FA(W)617, FA(W)617D		E-4617 Curbside	5.75"	10QH39P1	Use with tube 7QH253P1, 7QH253P2.
				E-4616 Roadside		10QH310P1	

Drag Links

Axle Rating Lbs.	Axle Code/Year	Part Number	Stud Center to Stud Center	OEM Reference	Notes
All	All	E-10114	2.75" Stud center to rod end	37QC34A	Power steering cylinder end.
		E-9881	5.75" Stud center to rod end	18QK201	Pinch bolt socket used on drag links with tight clearance.
10500	FA(W)536	E-9877	5.75" Stud center to rod end	18QK29301	Drag link end socket - RH thread. Use w/tube stamped 39305.
		E-9877		18QK23A	Drag link end socket - RH thread.
		E-9878		18QK28A	Drag link end socket - LH thread.
12000	FA(W)537	E-9877	5.75" Stud center to rod end	18QK29301	Drag link end socket - RH thread. Use w/tube stamped 39305.
		E-9877		18QK23A	Drag link end socket - RH thread.
		E-9878		18QK28A	Drag link end socket - LH thread.
18000	FA(W)616	E-9877	5.75" Stud center to rod end	18QK29301	Drag link end socket - RH thread. Use w/tube stamped 39305.
		E-9877		18QK23A	Drag link end socket - RH thread.
		E-9878		18QK28A	Drag link end socket - LH thread.
20000	FA(W)617	E-9877	5.75" Stud center to rod end	18QK23A	Drag link end socket - RH thread.
		E-9877		18QK29301	Drag link end socket - RH thread. Use w/tube stamped 39305.
		E-9878		18QK28A	Drag link end socket - LH thread.

MACK

MC400, MR400, MC600, MR600

King Pin Kits

Axle Rating Lbs.	Axle Code/Year	Part Number/ Bushing Type	King Pin Size	Type	OEM Reference	Notes
10500	FA(W)536	E-4467B Bronze	7.470"	E	301SQ47CP1	Tapered pin.
12000	FA(W)537	E-4467B Bronze	7.470"	E	301SQ47CP1	Tapered pin.
18000	FA(W)616	E-4599B Bronze	8.750"	E	301SQ52	Tapered pin.
20000	FA(W)617	E-4599B Bronze	8.750"	E	301SQ52	Tapered pin.

Tie Rod Ends

Axle Rating Lbs.	Axle Code/Year	Part Number/ Location	Stud Center to Rod End	OEM Reference	Notes
10500	FA(W)536	E-4611 Curbside	4.875"	10QH242P1	Coarse thread.
		E-4610 Roadside		10QH243P2	
		E-4640 Curbside		10QH243P1	Fine thread.
		E-9878 Curbside	5.75"		Side zerk.
		E-9877 Roadside			
		E-4617 Curbside		10QH39P1	
12000	FA(W)537	E-4616 Roadside		10QH310P1	
		E-9878 Curbside	5.75"		Side zerk.
		E-9877 Roadside			
		E-4617 Curbside		10QH39P1	
E-4616 Roadside	10QH310P1				
18000	FA(W)616	E-9878 Curbside	5.75"		Side zerk.
		E-9877 Roadside			
		E-4617 Curbside		10QH39P1	Use with tube 7QH253P1, 7QH253P2
		E-4616 Roadside	10QH310P1		
		E-4629 Curbside	7.37"	10QH311P1	Use with tube 7QH253P3, 7QH253P4
		E-4628 Roadside		10QH312P1	
		E-9879 Curbside		10QH311P1	Use with tube 7QH253P3, 7QH253P4.
		E-9880 Roadside	10QH312P1	Side zerk.	
20000	FA(W)617	E-9878 Curbside	5.75"		Side zerk.
		E-9877 Roadside			
		E-4617 Curbside		10QH39P1	Use with tube 7QH253P1, 7QH253P2
		E-4616 Roadside	10QH310P1		
		E-4629 Curbside	7.37"	10QH311P1	Use with tube 7QH253P3, 7QH253P4
		E-4628 Roadside		10QH312P1	
		E-9879 Curbside		10QH311P1	Use with tube 7QH253P3, 7QH253P4.
		E-9880 Roadside	10QH312P1	Side zerk.	

S.O.S.

Special Order Service

Can't find it?

Trouble sourcing products?

Need assistance?

Let Euclid's Special Order Service (**S.O.S.**) help you find your parts.

Euclid's position as the market leader provides you access to a comprehensive array of truck parts products from the industry's leading manufacturers. Through Euclid, these entire product lines are available to you just by placing a phone call to Euclid's S.O.S. Department at 866-238-2543 (option 2) in the U.S. or 800-387-3889 in Canada.

MC400, MR400, MC600, MR600 (Continued)

Drag Links

Axle Rating Lbs.	Axle Code/Year	Part Number	Stud Center to Stud Center	OEM Reference	Notes
All	All	E-10114	2.75" Stud center to rod end	37QC34A	Power steering cylinder end.
		E-9881	5.75" Stud center to rod end	18QK201	Pinch bolt socket used on drag links with tight clearance.
10500	FA(W)536	E-9877	5.75" Stud center to rod end	18QK29301	Drag link end socket - RH thread. Use w/tube stamped 39305.
		E-9877		18QK23A	Drag link end socket - RH thread.
		E-9878		18QK28A	Drag link end socket - LH thread.
12000	FA(W)537	E-9877	5.75" Stud center to rod end	18QK29301	Drag link end socket - RH thread. Use w/tube stamped 39305.
		E-9877		18QK23A	Drag link end socket - RH thread.
		E-9878		18QK28A	Drag link end socket - LH thread.
18000	FA(W)616	E-9877	5.75" Stud center to rod end	18QK29301	Drag link end socket - RH thread. Use w/tube stamped 39305.
		E-9877		18QK23A	Drag link end socket - RH thread.
		E-9878		18QK28A	Drag link end socket - LH thread.
20000	FA(W)617	E-9877	5.75" Stud center to rod end	18QK23A	Drag link end socket - RH thread.
		E-9877		18QK29301	Drag link end socket - RH thread. Use w/tube stamped 39305.
		E-9878		18QK28A	Drag link end socket - LH thread.

R400

King Pin Kits

Axle Rating Lbs.	Axle Code/Year	Part Number/ Bushings Type	King Pin Size	Type	OEM Reference	Notes
10500	FA532, FA(W)536	E-4467B Bronze	7.470"	E	301SQ47CP1	Tapered pin.
12000	FA(W)537	E-4467B Bronze	7.470"	E	301SQ47CP1	Tapered pin.
18000	FA(W)616	E-4599B Bronze	8.750"	E	301SQ52	Tapered pin.

Tie Rod Ends

Axle Rating Lbs.	Axle Code/Year	Part Number/ Location	Stud Center to Rod End	OEM Reference	Notes	
10500	FA(W)536	E-4611 Curbside	4.875"	10QH242P1	Coarse thread.	
		E-4610 Roadside		10QH243P2		
		E-4640 Curbside		10QH243P1	Fine thread.	
		E-9878 Curbside	5.75"		Side zerk.	
		E-9877 Roadside				
		E-4617 Curbside		10QH39P1		
	FA532	E-4616 Roadside		10QH310P1		
			E-4607 Curbside	4.875"	10QH38	
12000	FA(W)537	E-9878 Curbside	5.75"		Side zerk.	
		E-9877 Roadside				
		E-4617 Curbside		10QH39P1		
		E-4616 Roadside		10QH310P1		
18000	FA(W)616	E-9878 Curbside	5.75"		Side zerk.	
		E-9877 Roadside				
		E-4617 Curbside		10QH39P1		Use with tube 7QH253P1, 7QH253P2.
		E-4616 Roadside		10QH310P1		
		E-4629 Curbside	7.37"		10QH311P1	Use with tube 7QH253P3, 7QH253P4.
		E-4628 Roadside			10QH312P1	
		E-9879 Curbside			10QH311P1	Use with tube 7QH253P3, 7QH253P4.
		E-9880 Roadside		10QH312P1	Side zerk.	

MACK

R400 (Continued)

Drag Links

Axle Rating Lbs.	Axle Code/Year	Part Number	Stud Center to Stud Center	OEM Reference	Notes
All	All	E-10114	2.75" Stud center to rod end	37QC34A	Power steering cylinder end.
		E-9881	5.75" Stud center to rod end	18QK201	Pinch bolt socket used on drag links with tight clearance.
10500	FA(W)536	E-9877	5.75" Stud center to rod end	18QK23A	Drag link end socket - RH thread.
		E-9877		18QK29301	Drag link end socket - RH thread. Use w/tube stamped 39305.
		E-9878		18QK28A	Drag link end socket - LH thread.
12000	FA(W)537	E-9877	5.75" Stud center to rod end	18QK29301	Drag link end socket - RH thread. Use w/tube stamped 39305.
		E-9877		18QK23A	Drag link end socket - RH thread.
		E-9878		18QK28A	Drag link end socket - LH thread.
18000	FA(W)616	E-9877	5.75" Stud center to rod end	18QK29301	Drag link end socket - RH thread. Use w/tube stamped 39305.
		E-9877		18QK23A	Drag link end socket - RH thread.
		E-9878		18QK28A	Drag link end socket - LH thread.

R600, R685R, R685ST, R686ST

King Pin Kits

Axle Rating Lbs.	Axle Code/Year	Part Number/ Bushings Type	King Pin Size	Type	OEM Reference	Notes
10500	FA532, FA(W)536	E-4467B Bronze	7.470"	E	301SQ47CP1	Tapered pin.
12000	FA(W)537, FA(W)537C	E-4467B Bronze	7.470"	E	301SQ47CP1	Tapered pin.
18000	FA(W)616	E-4599B Bronze	8.750"	E	301SQ52	Tapered pin.
20000	FA(W)617	E-4599B Bronze	8.750"	E	301SQ52	Tapered pin.

Tie Rod Ends

Axle Rating Lbs.	Axle Code/Year	Part Number/ Location	Stud Center to Rod End	OEM Reference	Notes		
10500	FA(W)536, FA(W)536C	E-4611 Curbside	4.875"	10QH242P1	Coarse thread.		
		E-4610 Roadside		10QH243P2			
		E-4640 Curbside		10QH243P1	Fine thread.		
				E-9878 Curbside	5.75"		Side zerk.
				E-9877 Roadside			
				E-4617 Curbside		10QH39P1	
				E-4616 Roadside		10QH310P1	
12000	FA(W)537, FA(W)537C	E-4607 Curbside	5.75"	10QH38	Side zerk.		
		E-9878 Curbside					
		E-9877 Roadside					
		E-4617 Curbside		10QH39P1			
18000	FA(W)616	E-4616 Roadside	7.37"	10QH310P1	Side zerk.		
		E-9878 Curbside					
		E-9877 Roadside					
		E-4617 Curbside		10QH39P1		Use with tube 7QH2531P1, 7QH253P2	
		E-4616 Roadside		10QH310P1			
		E-4629 Curbside		10QH311P1		Use with tube 7QH253P3, 7QH253P4	
		E-4628 Roadside		10QH312P1			
		E-9879 Curbside		10QH311P1		Use with tube 7QH253P3, 7QH253P4.	
E-9880 Roadside	10QH312P1	Side zerk.					

R600, R685R, R685ST, R686ST (Continued)

Tie Rod Ends (Continued)

Axle Rating Lbs.	Axle Code/Year	Part Number/ Location	Stud Center to Rod End	OEM Reference	Notes	
20000	FA(W)617	E-9878 Curbside	5.75"		Side zerk.	
		E-9877 Roadside				
		E-4617 Curbside			10QH39P1	Use with tube 7QH2531P1, 7QH253P2
		E-4616 Roadside			10QH310P1	
		E-4629 Curbside	7.37"	10QH311P1	Use with tube 7QH253P3, 7QH253P4	
		E-4628 Roadside		10QH312P1		
		E-9879 Curbside		10QH311P1	Use with tube 7QH253P3, 7QH253P4.	
		E-9880 Roadside		10QH312P1		Side zerk.

Drag Links

Axle Rating Lbs.	Axle Code/Year	Part Number	Stud Center to Stud Center	OEM Reference	Notes
All	All	E-10114	2.75" Stud center to rod end	37QC34A	Power steering cylinder end.
		E-9881	5.75" Stud center to rod end	18QK201	Pinch bolt socket used on drag links with tight clearance.
10500	FA(W)536	E-9877	5.75" Stud center to rod end	18QK29301	Drag link end socket - RH thread. Use w/tube stamped 39305.
		E-9877		18QK23A	Drag link end socket - RH thread.
		E-9878		18QK28A	Drag link end socket - LH thread.
12000	FA(W)537	E-9877	5.75" Stud center to rod end	18QK23A	Drag link end socket - RH thread.
		E-9877		18QK29301	Drag link end socket - RH thread. Use w/tube stamped 39305.
		E-9878		18QK28A	Drag link end socket - LH thread.
18000	FA(W)616	E-9877	5.75" Stud center to rod end	18QK29301	Drag link end socket - RH thread. Use w/tube stamped 39305.
		E-9877		18QK23A	Drag link end socket - RH thread.
		E-9878		18QK28A	Drag link end socket - LH thread.

R600L, R600LS, R700L, R700LS, RWL700S, RWS700S, WL700L, W700LS, WS700L, WS700LS

King Pin Kits

Axle Rating Lbs.	Axle Code/Year	Part Number/ Bushing Type	King Pin Size	Type	OEM Reference	Notes
10500	FA(W)536	E-4467B Bronze	7.470"	E	301SQ47CP1	Tapered pin.
12000	FA(W)537	E-4467B Bronze	7.470"	E	301SQ47CP1	Tapered pin.
	FF931	E-4468B Bronze	1.794" x 10.392"	B	KIT 195	
	E-4694C Composite	KIT 1307				
18000	FL931	E-4458B Bronze	1.999" x 11.212"	B	KIT 198	
		E-4458C Composite			KIT 1312	



an **ArvinMeritor**™ brand

MACK

R600L, R600LS, R700L, R700LS, RWL700S, RWS700S, WL700L, W700LS, WS700L, WS700LS (Continued)

Tie Rod Ends

Axle Rating Lbs.	Axle Code/Year	Part Number/ Location	Stud Center to Rod End	OEM Reference	Notes
10500	FA(W)536	E-4611 Curbside	4.875"	10QH242P1	Coarse thread.
		E-4610 Roadside		10QH243P2	
		E-4640 Curbside		10QH243P1	
		E-9878 Curbside	5.75"		Fine thread. Side zerk.
		E-9877 Roadside			
		E-4617 Curbside		10QH39P1	
12000	FA(W)537	E-4616 Roadside		10QH310P1	
		E-9878 Curbside	5.75"		Side zerk.
		E-9877 Roadside			
		E-4617 Curbside		10QH39P1	
	E-4616 Roadside	10QH310P1			
	FF931	E-4615 Curbside	5.44"	A3144E524	Greaseable type.
E-4614 Roadside		A3144E525			
18000	FL931	E-4629 Curbside	7.37"	A3144V437	
		E-4628 Roadside		A3144U438	

Drag Links

Axle Rating Lbs.	Axle Code/Year	Part Number	Stud Center to Stud Center	OEM Reference	Notes
All	All	E-10114	2.75" Stud center to rod end	37QC34A	Power steering cylinder end.
		E-9881	5.75" Stud center to rod end	18QK201	Pinch bolt socket used on drag links with tight clearance.
10500	FA(W)536	E-9877	5.75" Stud center to rod end	18QK29301	Drag link end socket - RH thread. Use w/tube stamped 39305.
		E-9877		18QK23A	Drag link end socket - RH thread.
		E-9878		18QK28A	Drag link end socket - LH thread.
12000	FA(W)537	E-9877	5.75" Stud center to rod end	18QK29301	Drag link end socket - RH thread. Use w/tube stamped 39305.
		E-9877		18QK23A	Drag link end socket - RH thread.
		E-9878		18QK28A	Drag link end socket - LH thread.
18000	FA616	E-9877	5.75" Stud center to rod end	18QK29301	Drag link end socket - RH thread. Use w/tube stamped 39305.
		E-9877		18QK23A	Drag link end socket - RH thread.
		E-9878		18QK28A	Drag link end socket - LH thread.

RD400

King Pin Kits

Axle Rating Lbs.	Axle Code/Year	Part Number/ Bushing Type	King Pin Size	Type	OEM Reference	Notes
10500	FA532, FA(W)536	E-4467B Bronze	7.470"	E	301SQ47CP1	Tapered pin.
12000	FA(W)537	E-4467B Bronze	7.470"	E	301SQ47CP1	Tapered pin.
18000	FA(W)616	E-4599B Bronze	8.750"	E	301SQ52	Tapered pin.



RD400 (Continued)

Tie Rod Ends

Axle Rating Lbs.	Axle Code/Year	Part Number/ Location	Stud Center to Rod End	OEM Reference	Notes		
10500	FA(W)536	E-4611 Curbside	4.875"	10QH242P1	Coarse thread.		
		E-4610 Roadside		10QH243P2			
		E-4640 Curbside		10QH243P1	Fine thread.		
		12000	FA(W)537	E-9878 Curbside	5.75"		Side zerk.
				E-9877 Roadside			
				E-4617 Curbside		10QH39P1	
				E-4616 Roadside		10QH310P1	
18000	FA(W)616	E-9878 Curbside	5.75"		Side zerk.		
		E-9877 Roadside					
		E-4617 Curbside		10QH39P1	Use with tube 7QH2531P1, 7QH253P2		
		E-4616 Roadside		10QH310P1			
		E-4629 Curbside	7.37"	10QH311P1	Use with tube 7QH253P3, 7QH253P4		
		E-4628 Roadside		10QH312P1			
		E-9879 Curbside		10QH311P1	Use with tube 7QH253P3, 7QH253P4.		
		E-9880 Roadside		10QH312P1		Side zerk.	

Drag Links

Axle Rating Lbs.	Axle Code/Year	Part Number	Stud Center to Stud Center	OEM Reference	Notes
All	All	E-10114	2.75" Stud center to rod end	37QC34A	Power steering cylinder end.
		E-9881	5.75" Stud center to rod end	18QK201	Pinch bolt socket used on drag links with tight clearance.
10500	FA(W)536	E-9877	5.75" Stud center to rod end	18QK29301	Drag link end socket - RH thread. Use w/tube stamped 39305.
		E-9877		18QK23A	Drag link end socket - RH thread.
		E-9878		18QK28A	Drag link end socket - LH thread.
12000	FA(W)537	E-9877	5.75" Stud center to rod end	18QK23A	Drag link end socket - RH thread.
		E-9877		18QK29301	Drag link end socket - RH thread. Use w/tube stamped 39305.
		E-9878		18QK28A	Drag link end socket - LH thread.
18000	FA(W)616	E-9877	5.75" Stud center to rod end	18QK23A	Drag link end socket - RH thread.
		E-9877		18QK29301	Drag link end socket - RH thread. Use w/tube stamped 39305.
		E-9878		18QK28A	Drag link end socket - LH thread.

RD600, R700

King Pin Kits

Axle Rating Lbs.	Axle Code/Year	Part Number/ Bushing Type	King Pin Size	Type	OEM Reference	Notes
10500	FA532, FA(W)536	E-4467B Bronze	7.470"	E	301SQ47CP1	Tapered pin.
12000	FA(W)537	E-4467B Bronze	7.470"	E	301SQ47CP1	Tapered pin.
18000	FA(W)616	E-4599B Bronze	8.750"	E	301SQ52	Tapered pin.
20000	FA(W)617	E-4599B Bronze	8.750"	E	301SQ52	Tapered pin.

MACK

RD600, R700 (Continued)

Tie Rod Ends

Axle Rating Lbs.	Axle Code/Year	Part Number/Location	Stud Center to Rod End	OEM Reference	Notes		
10500	FA(W)536	E-4611 Curbside	4.875"	10QH242P1	Coarse thread.		
		E-4610 Roadside		10QH243P2			
		E-4640 Curbside		10QH243P1			
		E-9878 Curbside	5.75"			Side zerk.	
		E-9877 Roadside					
		E-4617 Curbside					10QH39P1
		E-4616 Roadside					10QH310P1
		E-4607 Curbside					10QH38
12000	FA(W)537	E-9878 Curbside	5.75"		Side zerk.		
E-9877 Roadside							
E-4617 Curbside	10QH39P1						
E-4616 Roadside	10QH310P1						
18000	FA(W)616	E-9878 Curbside	5.75"		Side zerk.		
		E-9877 Roadside					
		E-4617 Curbside				10QH39P1	
		E-4616 Roadside				10QH310P1	
		E-4629 Curbside	7.37"		10QH311P1	Use with tube 7QH253P3, 7QH253P4.	
		E-4628 Roadside			10QH312P1	For units built after 2/20/84.	
		E-9879 Curbside			10QH311P1	Use with tube 7QH253P3, 7QH253P4.	
		E-9880 Roadside			10QH312P1	For units built after 2/20/84. Side zerk.	
20000	FA(W)617	E-9878 Curbside	5.75"		Side zerk.		
		E-9877 Roadside					
		E-4617 Curbside				10QH39P1	
		E-4616 Roadside				10QH310P1	
		E-4629 Curbside	7.37"		10QH311P1	Use with tube 7QH253P3, 7QH253P4.	
		E-4628 Roadside			10QH312P1	For units built after 2/20/84.	
		E-9879 Curbside			10QH311P1	Use with tube 7QH253P3, 7QH253P4.	
		E-9880 Roadside			10QH312P1	For units built after 2/20/84. Side zerk.	

Drag Links

Axle Rating Lbs.	Axle Code/Year	Part Number	Stud Center to Stud Center	OEM Reference	Notes
All	All	E-10114	2.75" Stud center to rod end	37QC34A	Power steering cylinder end.
		E-9881	5.75" Stud center to rod end	18QK201	Pinch bolt socket used on drag links with tight clearance.
10500	FA(W)536	E-9877	5.75" Stud center to rod end	18QK23A	Drag link end socket - RH thread.
		E-9877		18QK29301	Drag link end socket - RH thread. Use w/tube stamped 39305.
		E-9878		18QK28A	Drag link end socket - LH thread.
12000	FA(W)537	E-9877	5.75" Stud center to rod end	18QK29301	Drag link end socket - RH thread. Use w/tube stamped 39305.
		E-9877		18QK23A	Drag link end socket - RH thread.
		E-9878		18QK28A	Drag link end socket - LH thread.
18000	FA(W)616	E-9877	5.75" Stud center to rod end	18QK23A	Drag link end socket - RH thread.
		E-9877		18QK29301	Drag link end socket - RH thread. Use w/tube stamped 39305.
		E-9878		18QK28A	Drag link end socket - LH thread.

U600, U68ST, F700, F786ST, R767ST

King Pin Kits

Axle Rating Lbs.	Axle Code/Year	Part Number/ Bushing Type	King Pin Size	Type	OEM Reference	Notes
10500	FA532, FA(W)536	E-4467B Bronze	7.470"	E	301SQ47CP1	Tapered pin.
12000	FA(W)537	E-4467B Bronze	7.470"	E	301SQ47CP1	Tapered pin.

Tie Rod Ends

Axle Rating Lbs.	Axle Code/Year	Part Number/ Location	Stud Center to Rod End	OEM Reference	Notes
10500	FA(W)536	E-4611 Curbside	4.875"	10QH242P1	Coarse thread.
		E-4610 Roadside		10QH243P2	
		E-4640 Curbside		10QH243P1	Fine thread.
		E-9878 Curbside	5.75"		Side zerk.
		E-9877 Roadside			
		E-4617 Curbside		10QH39P1	
		E-4616 Roadside		10QH310P1	
	FA532	E-4607 Curbside	4.875"	10QH38	
12000	FA(W)537	E-9878 Curbside	5.75"		Side zerk.
		E-9877 Roadside			
		E-4617 Curbside		10QH39P1	
		E-4616 Roadside		10QH310P1	

Drag Links

Axle Rating Lbs.	Axle Code/Year	Part Number	Stud Center to Stud Center	OEM Reference	Notes
All	All	E-10114	2.75" Stud center to rod end	37QC34A	Power steering cylinder end.
		E-9881	5.75" Stud center to rod end	18QK201	Pinch bolt socket used on drag links with tight clearance.
10500	FA(W)536	E-9877	5.75" Stud center to rod end	18QK23A	Drag link end socket - RH thread.
		E-9877		18QK29301	Drag link end socket - RH thread. Use w/tube stamped 39305.
		E-9878		18QK28A	Drag link end socket - LH thread.
12000	FA(W)537	E-9877	5.75" Stud center to rod end	18QK29301	Drag link end socket - RH thread. Use w/tube stamped 39305.
		E-9877		18QK23A	Drag link end socket - RH thread.
		E-9878		18QK28A	Drag link end socket - LH thread.

S.O.S.

Special Order Service

Can't find it?

Trouble sourcing products?

Need assistance?

Let Euclid's Special Order Service (S.O.S.) help you find your parts.

Euclid's position as the market leader provides you access to a comprehensive array of truck parts products from the industry's leading manufacturers. Through Euclid, these entire product lines are available to you just by placing a phone call to Euclid's S.O.S. Department at 866-238-2543 (option 2) in the U.S. or 800-387-3889 in Canada.

INDEX

Model	Page No.	Model	Page No.
16612, 16613, 16616	11-132	FF-931, FF-932, FF-933, FF-934, FF-941, FF-942, FF-943, FF-944	11-135
16930, 16931	11-132	FF-931A, FF-941A - Aluminum Axles	11-135
17100, 17101, 17111	11-132	FF-971	11-135
27460-A, 27465-A	11-132	FF-981, FF-982, FF-986	11-135
FC-901, FC-902, FC-903	11-132	FG-900, FG-903	11-136
FC-921	11-132	FG-931, FG-933, FG-941, FG943	11-136
FC-931	11-133	FG-943	11-136
FD-900	11-133	FH-901	11-136
FD-901, FD-902, FD-203	11-133	FL-901	11-136
FD-931, FD-933	11-133	FL-931, FL-933	11-137
FD-961, FF-961	11-133	FL-941, FL-943	11-137
FDS1805FWD, FDS1807FWD	11-133	FL-951	11-137
FE-900, FE-903, FE-910	11-134	FU-910	11-138
FE-970	11-134	MFS	11-138
FF-901, FF-903	11-134	Meritor Easy Steer™ Front Axle Specifications	11-131
FF-921, FF-923	11-134	Meritor Model Nomenclature	11-129
FF-930	11-135		

For additional: Parts Information
 Cross Reference
 Production Bills of Material

visit our online catalog at: www.XpresswayPlus.com

MERITOR NON-DRIVING FRONT AXLE MODEL NOMENCLATURE

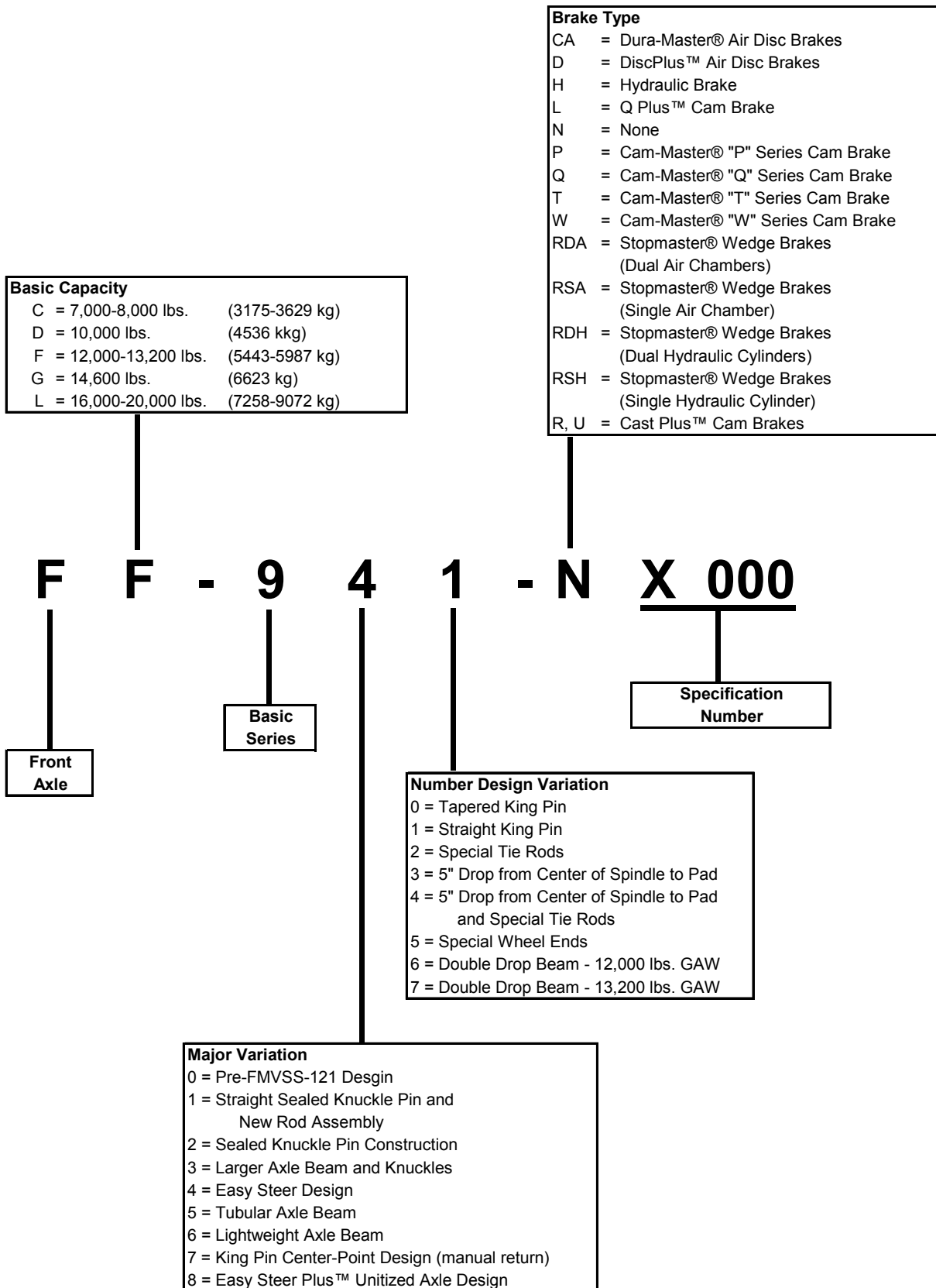

MERITOR NON-DRIVING FRONT AXLE MODEL NOMENCLATURE

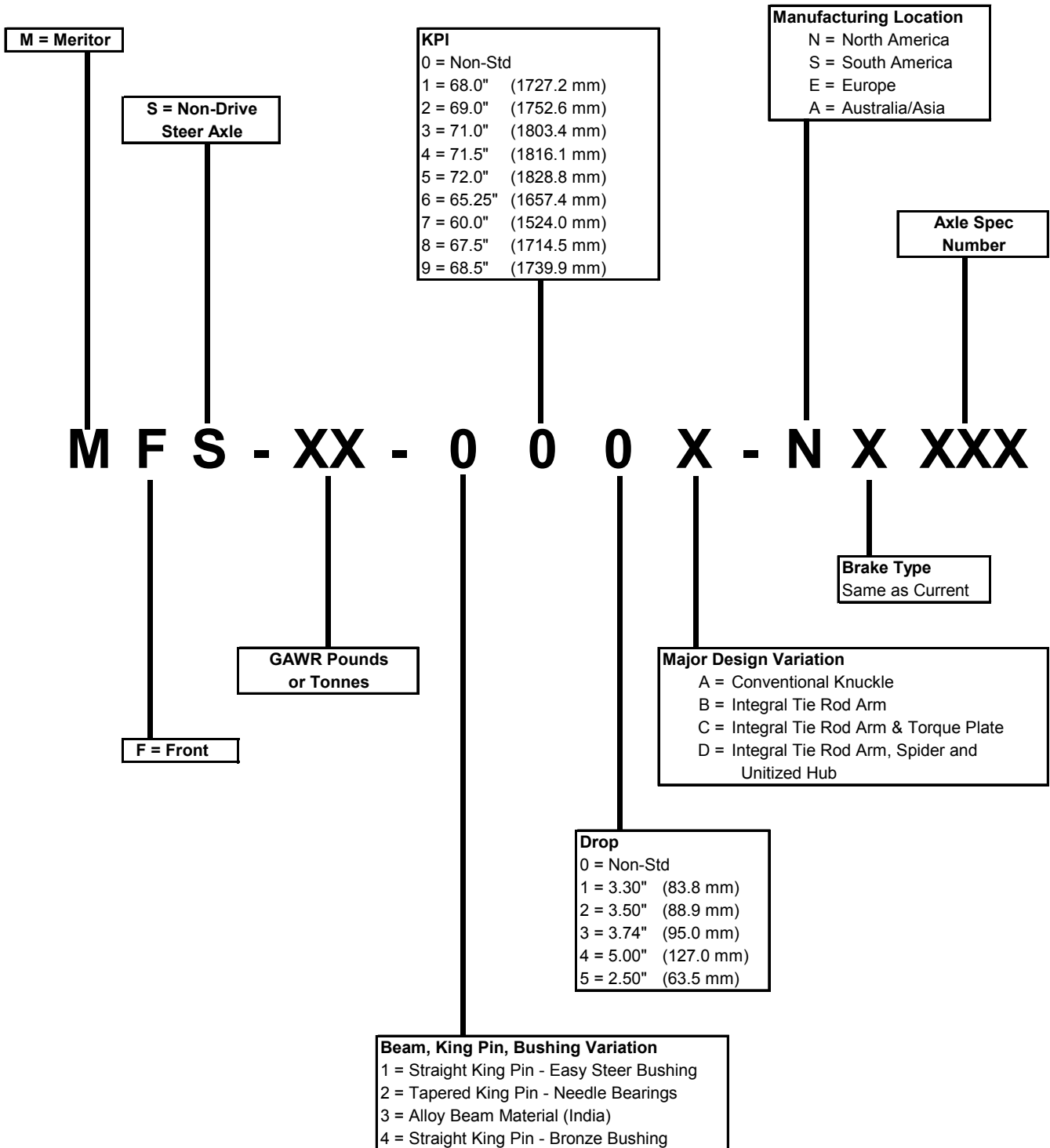

Meritor Easy Steer™ Non-Drive Front Axle Specifications

Axle Model Part Numbers	Rating Lbs.	Wheel End Options	KPI Inches	Drop Inches	Nominal Track Inches	Weight Lbs. *
MFS-6-151A-N	6,000	D	72	3.30	84	268
MFS-7-113C-N	7,000	D	68	3.74	80	289
MFS-7-153C-N	7,000	D	72	3.74	84	308
MFS-7-163C-N	7,000	D	65.25	3.74	77.25	275
MFS-8-113B-N	8,000	B	68	3.74	78.05	270
MFS-8-153B-N	8,000	B	72	3.74	82.05	289
MFS-8-163B-N	8,000	B	65.25	3.74	75.3	266
FC-941	8,000	A	68	3.60	78.05	280
FC-965	8,000	A	69	3.50	78.99	330
FD-965	10,000	A	69	3.50	78.99	330
MFS-10-143A-N	10,000	A	71.5	3.74	82	330
MFS-10-143D-N	10,000	C	71.5	3.74	80.4	523*
MFS-10-144A-N	10,000	A	71.5	5.00	82	368
MFS-10-144D-N	10,000	C	71.5	5.00	82	561*
MFS-12-143A-N	12,000	A	71.5	3.74	82	330
MFS-12-143D-N	12,000	C	71.5	3.74	80.4	523*
MFS-12-144A-N	12,000	A	71.5	5.00	82	368
MFS-12-144D-N	12,000	C	71.5	5.00	82	561*
FF-941	12,000	A	69	3.50	78.99	355
FF-943	12,000	A	69	5.00	78.99	363
FF-961	12,000	A	69	3.50	78.99	330
FF-966	12,000	A	69	3.5/2	78.96	342
FF-981	12,000	C	69	3.50	79.55	523*
FF-983	12,000	C	69	5.00	79.55	538*
FF-986	12,000	C	69	3.5/2	79.55	535*
FF-982	13,200	C	69	3.50	79.55	538*
FF-984	13,200	C	69	5.00	79.55	560*
FF-987	13,200	C	69	3.5/2	79.55	540*
FF-967	13,200	A	69	3.5/2	79.54	347
FF-942	13,200	A	69	3.50	78.99	363
FF-944	13,200	A	69	5.00	78.99	385
MFS-13-143A-N	13,200	A	71.5	3.74	81	388
MFS-13-144A-N	13,200	A	71.5	5.00	81	368
MFS-13-144D-N	13,200	C	71.5	5.00	81	561*
FG-941	14,600	A	69	3.50	78.32	370
FG-943	14,600	A	69	5.00	78.32	380
MFS-14-143A-N	14,700	A	71.5	3.74	81	388
MFS-14-144A-N	14,700	A	71.5	5.00	81	368
MFS-16-143A-N	16,000	A	71.5	3.74	84.75	425
MFS-16-122A-N	16,000	A	69	3.50	82.25	456
FL-941	16,000	A	68.5	3.50	81.74	470
FL-943	16,000	A	68.83	5.00	81.74	480
FL-941	18,000	A	68.5	3.50	81.74	470
MFS-18-133A-N	18,000	A	71	3.74	84.25	460
FL-943	18,000	A	68.83	5.00	81.74	480
FL-941	20,000	A	68.5	3.50	81.74	470
FL-943	20,000	A	68.83	5.00	81.74	480
MFS-20-133A-N	20,000	A	71	3.74	84.25	460

Wheel End Options:

- A - Conventional Hub with Standard Knuckle
- B - Conventional Hub with Integral Tie Rod Knuckle
- C - Unitized Wheel End with Integral Tie Rod and Spider Knuckle
- D - Conventional Hub with Integral Tie Rod and Torque Plate

* Weights shown for axles with unitized wheel ends include: standard track axles with one steering arm and both hubs (includes bearings and seals) but no brakes.

MERITOR

16612, 16613, 16616

King Pin Kits

Axle Rating Lbs.	Axle Code/Year	Part Number/ Bushing Type	King Pin Size	Type	OEM Reference	Notes
12000		E-4434B Bronze	9.750"	D	KIT 144	Tapered pin. Contains cotter pins and nuts.
		E-4434N Bronze, Nylon			KIT 123	Tapered pin.

16930, 16931

Tie Rod Ends

Axle Rating Lbs.	Axle Code/Year	Part Number/ Location	Stud Center to Rod End	OEM Reference	Notes
12000		E-4615 Curbside	5.44"	A3144D524	Greaseable type.
		E-4614 Roadside		A3144E525	
		E-4617 Curbside	5.75"	A3144J296	
		E-4616 Roadside		A3144K297	

17100, 17101, 17111

King Pin Kits

Axle Rating Lbs.	Axle Code/Year	Part Number/ Bushing Type	King Pin Size	Type	OEM Reference	Notes
14600		E-4695C Composite	1.794" x 10.392"	B	KIT 1309	
		E-6868B Bronze			KIT 1310	

Tie Rod Ends

Axle Rating Lbs.	Axle Code/Year	Part Number/ Location	Stud Center to Rod End	OEM Reference	Notes
14600		E-4617 Curbside	5.75"	A3144J296	Greaseable type.
		E-4616 Roadside		A3144K297	

27460-A, 27465-A

Tie Rod Ends

Axle Rating Lbs.	Axle Code/Year	Part Number/ Location	Stud Center to Rod End	OEM Reference	Notes
		E-4611 Curbside	4.875"	A3144R226	
		E-4610 Roadside		A3144Q225	

FC-901, FC-902, FC-903

King Pin Kits

Axle Rating Lbs.	Axle Code/Year	Part Number/ Bushing Type	King Pin Size	Type	OEM Reference	Notes
7000		E-4438B Bronze	1.234" x 7.438"	B	KIT 143	
		E-4438N Nylon			KIT 155	

Tie Rod Ends

Axle Rating Lbs.	Axle Code/Year	Part Number/ Location	Stud Center to Rod End	OEM Reference	Notes
7000		E-4603 Curbside	3.875"	A3144V386	
		E-4602 Roadside		A3144U385	

MERITOR

FC-921

Tie Rod Ends

Axle Rating Lbs.	Axle Code/Year	Part Number/ Location	Stud Center to Rod End	OEM Reference	Notes
7000		E-4603 Curbside	3.875"	A3144V386	
		E-4602 Roadside		A3144U385	

FC-931

Tie Rod Ends

Axle Rating Lbs.	Axle Code/Year	Part Number/ Location	Stud Center to Rod End	OEM Reference	Notes
7000		E-4611 Curbside	4.875"	A2-3144J192	
		E-4610 Roadside		A2-3144K193	

FD-900

King Pin Kits

Axle Rating Lbs.	Axle Code/Year	Part Number/ Bushing Type	King Pin Size	Type	OEM Reference	Notes
9000		E-4435B Bronze	8.750"	D	KIT 141	Tapered pin.

FD-901, FD-902, FD-203

King Pin Kits

Axle Rating Lbs.	Axle Code/Year	Part Number/ Bushing Type	King Pin Size	Type	OEM Reference	Notes
9000		E-4441B Bronze	1.434" x 8.500"	B	KIT 142	

Tie Rod Ends

Axle Rating Lbs.	Axle Code/Year	Part Number/ Location	Stud Center to Rod End	OEM Reference	Notes
9000		E-4611 Curbside	4.875"	A3144R226	
		E-4610 Roadside		A3144Q225	

FD-931, FD-933

Tie Rod Ends

Axle Rating Lbs.	Axle Code/Year	Part Number/ Location	Stud Center to Rod End	OEM Reference	Notes
9000		E-4615 Curbside	5.44"	A3144D524	Greaseable type.
		E-4614 Roadside		A3144E525	

FD-961, FF-961

King Pin Kits

Axle Rating Lbs.	Axle Code/Year	Part Number/ Bushing Type	King Pin Size	Type	OEM Reference	Notes
10000, 12000		E-6199B Bronze	1.794" x 10.392"	B	KIT 1315	
		E-6199C Composite				

Tie Rod Ends

Axle Rating Lbs.	Axle Code/Year	Part Number/ Location	Stud Center to Rod End	OEM Reference	Notes
10000, 12000		E-4615 Curbside	5.44"	A3144D524	Greaseable type.
		E-4614 Roadside		A3144E525	

MERITOR

FDS1805FWD, FDS1807FWD

Tie Rod Ends

Axle Rating Lbs.	Axle Code/Year	Part Number/ Location	Stud Center to Rod End	OEM Reference	Notes
18000		E-4642 Curbside	5.75"	R230077	After 2/2/83. 1.25"-16 RH thread.
		E-6858 Roadside		R230095	After 2/2/83. 1.25"-18 RH thread.
		E-4619 Roadside		R230066	Before 2/2/83. 1.25"-12 RH thread.

FE-900, FE-903, FE-910

King Pin Kits

Axle Rating Lbs.	Axle Code/Year	Part Number/ Bushing Type	King Pin Size	Type	OEM Reference	Notes
11000		E-4434B Bronze	9.750"	D	KIT 144	Tapered pin.
		E-4434N Bronze, Nylon			KIT 123	

Tie Rod Ends

Axle Rating Lbs.	Axle Code/Year	Part Number/ Location	Stud Center to Rod End	OEM Reference	Notes
11000		E-4611 Curbside	4.875"	A3144R226	
		E-4610 Roadside		A3144Q225	
		E-4617 Curbside	5.75"	A3144J296	
		E-4616 Roadside		A3144K297	

FE-970

King Pin Kits

Axle Rating Lbs.	Axle Code/Year	Part Number/ Bushing Type	King Pin Size	Type	OEM Reference	Notes
11000		E-4449B Bronze	1.607" x 8.740"	B	KIT 157	Center point steering. Contains dust cap and screws.

Tie Rod Ends

Axle Rating Lbs.	Axle Code/Year	Part Number/ Location	Stud Center to Rod End	OEM Reference	Notes
11000		E-4611 Curbside	4.875"	A2-3144J192	
		E-4610 Roadside		A2-3144K193	
		E-6848 Curbside	10.50"	A3144N534	
		E-6847 Roadside		A3144M533	

FF-901, FF-903

King Pin Kits

Axle Rating Lbs.	Axle Code/Year	Part Number/ Bushing Type	King Pin Size	Type	OEM Reference	Notes
12000		E-4442B Bronze	1.794" x 9.120"	B	KIT 172	

Tie Rod Ends

Axle Rating Lbs.	Axle Code/Year	Part Number/ Location	Stud Center to Rod End	OEM Reference	Notes	
12000		E-4611 Curbside	4.875"	A3144R226		
		E-4610 Roadside		A3144Q225		
		E-4618 Curbside	5.75"	A3144D238		Lube fitting, bottom.
		E-4619 Roadside		A3144C237		
		E-4617 Curbside	A3144J296	Lube fitting, side.		
		E-4616 Roadside	A3144K297			

MERITOR

FF-921, FF-923

King Pin Kits

Axle Rating Lbs.	Axle Code/Year	Part Number/ Bushings Type	King Pin Size	Type	OEM Reference	Notes
12000		E-4450B Bronze	1.794" x 10.410"	B	KIT 193	

Tie Rod Ends

Axle Rating Lbs.	Axle Code/Year	Part Number/ Location	Stud Center to Rod End	OEM Reference	Notes
12000		E-4615 Curbside	5.44"	A3144D524	Greaseable type.
		E-4614 Roadside		A3144E525	

FF-930

Tie Rod Ends

Axle Rating Lbs.	Axle Code/Year	Part Number/ Location	Stud Center to Rod End	OEM Reference	Notes
12000		E-4615 Curbside	5.44"	A3144D524	Greaseable type.
		E-4614 Roadside		A3144E525	
		E-4617 Curbside	5.75"	A3144J296	
		E-4616 Roadside		A3144K297	

FF-931, FF-932, FF-933, FF-934, FF-941, FF-942, FF-943, FF-944

King Pin Kits

Axle Rating Lbs.	Axle Code/Year	Part Number/ Bushings Type	King Pin Size	Type	OEM Reference	Notes
12000		E-4468B Bronze	1.794" x 10.392"	B	KIT 195	
		E-4694C Composite			KIT 1307	
		E-6199B Bronze				
		E-6199C Composite			KIT 1315	

Tie Rod Ends

Axle Rating Lbs.	Axle Code/Year	Part Number/ Location	Stud Center to Rod End	OEM Reference	Notes
12000		E-4615 Curbside	5.44"	A3144D524	Greaseable type.
		E-4614 Roadside		A3144E525	

FF-931A, FF-941A - Aluminum Axles

Tie Rod Ends

Axle Rating Lbs.	Axle Code/Year	Part Number/ Location	Stud Center to Rod End	OEM Reference	Notes
12000		E-4615 Curbside	5.44"	A3144D524	Greaseable type.
		E-4614 Roadside		A3144E525	

FF-971

King Pin Kits

Axle Rating Lbs.	Axle Code/Year	Part Number/ Bushings Type	King Pin Size	Type	OEM Reference	Notes
12000		E-4595B Bronze	1.607" x 9.375"	B	KIT 1300	Center point steering.

Tie Rod Ends

Axle Rating Lbs.	Axle Code/Year	Part Number/ Location	Stud Center to Rod End	OEM Reference	Notes
12000		E-6848 Curbside	10.50"	A3144N534	Will retrofit older axles.
		E-6847 Roadside		A3144M533	

MERITOR

FF-981, FF-982, FF-986

Tie Rod Ends

Axle Rating Lbs.	Axle Code/Year	Part Number/ Location	Stud Center to Rod End	OEM Reference	Notes
12000		E-4615 Curbside	5.44"	A3144E525	
		E-4614 Roadside		A3144D524	

FG-900, FG-903

Tie Rod Ends

Axle Rating Lbs.	Axle Code/Year	Part Number/ Location	Stud Center to Rod End	OEM Reference	Notes
14600		E-4611 Curbside	4.875"	A3144R226	
		E-4610 Roadside		A3144Q225	

FG-931, FG-933, FG-941, FG943

King Pin Kits

Axle Rating Lbs.	Axle Code/Year	Part Number/ Bushing Type	King Pin Size	Type	OEM Reference	Notes
14600		E-4695C Composite	1.794" x 10.392"	B	KIT 1309	
		E-6868B Bronze			KIT 1310	

Tie Rod Ends

Axle Rating Lbs.	Axle Code/Year	Part Number/ Location	Stud Center to Rod End	OEM Reference	Notes
14600		E-4615 Curbside	5.44"	A3144D524	Greaseable type.
		E-4614 Roadside		A3144E525	

FG-943

King Pin Kits

Axle Rating Lbs.	Axle Code/Year	Part Number/ Bushing Type	King Pin Size	Type	OEM Reference	Notes
14600		E-4695C Composite	1.794" x 10.392"	B	KIT 1309	
		E-6868B Bronze			KIT 1310	

Tie Rod Ends

Axle Rating Lbs.	Axle Code/Year	Part Number/ Location	Stud Center to Rod End	OEM Reference	Notes
14600		E-4615 Curbside	5.44"	A3144D524	Greaseable type.
		E-4614 Roadside		A3144E525	

FH-901

King Pin Kits

Axle Rating Lbs.	Axle Code/Year	Part Number/ Bushing Type	King Pin Size	Type	OEM Reference	Notes
16000		E-4454B Bronze	1.999" x 11.040"	B	KIT 170	
		E-4454N Nylon			KIT 168	

Tie Rod Ends

Axle Rating Lbs.	Axle Code/Year	Part Number/ Location	Stud Center to Rod End	OEM Reference	Notes
16000		E-4617 Curbside	5.75"	A3144J296	Greaseable type.
		E-4616 Roadside		A3144K297	

MERITOR

FL-901

King Pin Kits

Axle Rating Lbs.	Axle Code/Year	Part Number/ Bushings Type	King Pin Size	Type	OEM Reference	Notes
18000		E-4454B Bronze	1.999" x 11.040"	B	KIT 170	
		E-4454N Nylon			KIT 168	

Tie Rod Ends

Axle Rating Lbs.	Axle Code/Year	Part Number/ Location	Stud Center to Rod End	OEM Reference	Notes
18000		E-4617 Curbside	5.75"	A3144J296	Greaseable type.
		E-4616 Roadside		A3144K297	

FL-931, FL-933

King Pin Kits

Axle Rating Lbs.	Axle Code/Year	Part Number/ Bushings Type	King Pin Size	Type	OEM Reference	Notes
16000, 18000, 20000		E-4458B Bronze	1.999" x 11.212"	B	KIT 198	
		E-4458C Composite			KIT 1312	

Tie Rod Ends

Axle Rating Lbs.	Axle Code/Year	Part Number/ Location	Stud Center to Rod End	OEM Reference	Notes
16000, 18000, 20000		E-4617 Curbside	5.75"	A3144J296	
		E-4616 Roadside		A3144K297	
		E-4629 Curbside	7.37"	A3144F448	
		E-4628 Roadside		A3144G449	
		E-6856 Curbside	12.688"	A3144D550	
		E-6857 Roadside		A3144C549	

FL-941, FL-943

King Pin Kits

Axle Rating Lbs.	Axle Code/Year	Part Number/ Bushings Type	King Pin Size	Type	OEM Reference	Notes
16000, 18000, 20000		E-4458B Bronze	1.999" x 11.212"	B	KIT 198	
		E-4458C Composite			KIT 1312	

Tie Rod Ends

Axle Rating Lbs.	Axle Code/Year	Part Number/ Location	Stud Center to Rod End	OEM Reference	Notes
16000, 18000, 20000		E-4617 Curbside	5.75"	A3144J296	
		E-4616 Roadside		A3144K297	
		E-4629 Curbside	7.37"	A3144F448	
		E-4628 Roadside		A3144G449	
		E-6856 Curbside	12.688"	A3144D550	
		E-6857 Roadside		A3144C549	

FL-951

King Pin Kits

Axle Rating Lbs.	Axle Code/Year	Part Number/ Bushings Type	King Pin Size	Type	OEM Reference	Notes
22000		E-4458B Bronze	1.999" x 11.212"	B	KIT 198	
		E-4458C Composite			KIT 1312	

MERITOR

FL-951 (Continued)

Tie Rod Ends

Axle Rating Lbs.	Axle Code/Year	Part Number/ Location	Stud Center to Rod End	OEM Reference	Notes
22000		E-4629 Curbside	7.37"	A3144F448	
		E-4628 Roadside		A3144G449	

FU-910

Tie Rod Ends

Axle Rating Lbs.	Axle Code/Year	Part Number/ Location	Stud Center to Rod End	OEM Reference	Notes
28000		E-4611 Curbside	4.875"	A3144R226	
		E-4610 Roadside		A3144Q225	

MFS

King Pin Kits

Axle Rating Lbs.	Axle Code/Year	Part Number/ Bushing Type	King Pin Size	Type	OEM Reference	Notes
6000	MFS06	E-11815C Composite	1.234" x 6.781"	A	R201478	
7000	MFS07	E-11816C Composite	1.498" x 7.153"	B	R201479	
8000	MFS08	E-11812C Composite	1.499" x 7.511"	B	R201474	
10000	MFS10	E-11809C Composite	1.794" x 10.392"	B	R201470	
12000	MFS12	E-11808C Composite	1.794" x 8.844"	B	R201419	
		E-11809C Composite			R201470	Uses 1 drawkey 3.68" long and 1 drawkey 3.25" long.
		E-11811C Composite			R201473	Uses 1 drawkey 3.88" long and 1 drawkey 3.25" long.
13000	MFS13	E-11808C Composite	1.794" x 8.844"	B	R201419	
		E-11810C Composite	1.794" x 10.392"		R201471	
14000	MFS14	E-11810C Composite	1.794" x 10.392"	B	R201471	
16000	MFS16	E-11814C Composite	1.999" x 11.212"	B	R201476	
18000	MFS18	E-11813C Composite	1.999" x 11.212"	B	R201475	Uses 1 drawkey 3.88" long and 1 drawkey 3.25" long.
		E-11814C Composite			R201476	Uses 1 drawkey 4.69" long and 1 drawkey 3.25" long.
20000	MFS20	E-11814C Composite	1.999" x 11.212"	B	R201476	

If you detect any **errors** in this Catalog, please let us know.

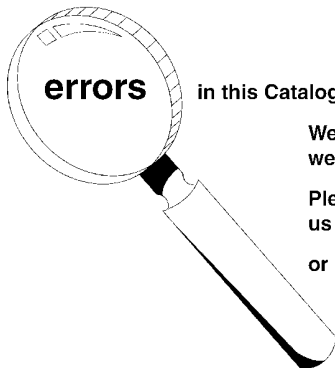

We want the information to be as accurate as possible; we appreciate your help in making it so.

Please e-mail any comments/suggestions/corrections to us at: catalogfeedback@arvinmeritor.com

or mail to: **Euclid Industries, LLC**
Attn: Catalog Dept.
7975 Dixie Highway
Florence, KY 41042-2754

Axle Rating Lbs.	Axle Code/Year	Part Number/ Location	Stud Center to Rod End	OEM Reference	Notes
8000	MFS08	E-4615 Curbside	5.44"	A3144D524	
		E-4614 Roadside		A3144E525	
10000	MFS10	E-4615 Curbside	5.44"	A3144D524	
		E-4614 Roadside		A3144E525	
12000	MFS12	E-4615 Curbside	5.44"	A3144D524	
		E-4614 Roadside		A3144E525	
13000	MFS13	E-4615 Curbside	5.44"	A3144D524	
		E-4614 Roadside		A3144E525	
14000	MFS14	E-4615 Curbside	5.44"	A3144D524	
		E-4614 Roadside		A3144E525	
		E-4629 Curbside	7.37"	A3144F448	
		E-4628 Roadside		A3144G449	
16000	MFS16	E-4615 Curbside	5.44"	A3144D524	
		E-4614 Roadside		A3144E525	
		E-4629 Curbside	7.37"	A3144F448	
		E-4628 Roadside		A3144G449	
		E-6856 Curbside	12.688"	A3144D550	
		E-6857 Roadside		A3144C549	
18000	MFS18	E-4615 Curbside	5.44"	A3144D524	
		E-4614 Roadside		A3144E525	
		E-4629 Curbside	7.37"	A3144F448	
		E-4628 Roadside		A3144G449	
		E-6856 Curbside	12.688"	A3144D550	
		E-6857 Roadside		A3144C549	
20000	MFS20	E-4615 Curbside	5.44"	A3144D524	
		E-4614 Roadside		A3144E525	
		E-4629 Curbside	7.37"	A3144F448	
		E-4628 Roadside		A3144G449	
		E-6856 Curbside	12.688"	A3144D550	
		E-6857 Roadside		A3144C549	

S.O.S.

Special Order Service

Can't find it?

Trouble sourcing products?

Need assistance?

Let Euclid's Special Order Service (S.O.S.) help you find your parts.

Euclid's position as the market leader provides you access to a comprehensive array of truck parts products from the industry's leading manufacturers. Through Euclid, these entire product lines are available to you just by placing a phone call to Euclid's S.O.S.

Department at 866-238-2543 (option 2) in the U.S. or 800-387-3889 in Canada.

INDEX

Model	Page No.
1300A, 1300B, 1300C 4WD	11-141
1300D 4WD	11-141
1310 4WD	11-141
3700, 3800, 3900	11-141
4600, 4700, 4800, 4900	11-141
7100	11-142
8100, 8200, 8300 (Built 1989 and Later)	11-144
9200	11-145
9300, 9400	11-146
9600, 9700	11-148
Additional Navistar Axles	11-150
C1200 4WD	11-153
CO/COF9670, Eagle	11-153
CO4000, COF4000, COT4000	11-154
COF5870	11-155
Cargostar Models CO1610, CO1630, CO1710, CO1730, CO1750, CO1810, COF1810, CO1830, CO1850, CO1910, COF1910, CO1950, COF1950	11-156
D400, DC400, DCF400, DCF400M, DF400, D405, DC405, DCF405, DCT405, DF405, DT405	11-156
Fleetstar Models 1900, F1900, T1900, F1900A, 1910A, 1950, F1950, T1950, 2000, F2000, T2000, 2010A, F2010A, 2050A, F2050A, 2070A, F2070A, 2110A	11-158

Model	Page No.
Loadstar and School Bus Models 1600, CO1600, F1600, 1700, CO1700, F1700, 1750, CO1750, 1800, CO1800, F1800, 1850, CO1850, F1850, 1890	11-160
M1400, 1452, 1652, M1600	11-161
Paystar Models 5010, F5010, 5050, F5050, F5050SF, F5050SF-LW, 5070, F5070, F5070SF, F5070SF-LW, CO5370, COF5370	11-162
S-Series Heavy Duty Models 2275, F2275, 2276, F2276, 2375, F2375, 2524, F2524, 2554, F2554, 2574, F2574, 2575, F2575, 2624, F2624, 2654, F2654, 2674, F2674, 2675, F2675	11-163
S-Series Heavy Duty Models 2554, 2574, 2654, 2674 (Built 1989 and Later)	11-165
S-Series Medium Duty Models 1624, 1654, 1658, 1723, 1724, 1753, 1754, 1758, 1823, 1824, 1853, 1854, 1858, 1924, F1924, 1925, 1954, F1954, 1955, 1958, 2125, F2125, 2155	11-166
Transtar 4070B, CO4070B, F4070B, COF4070B, 4170, F4170	11-169
Transtar CO4070A, COF4070A	11-170
Transtar Models 4200, F4200, 4300, F4300	11-171



"S" SERIES SCHOOL BUS



TILT CAB-CARGOSTAR

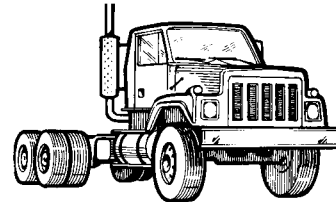

"S" SERIES (2100-2600)

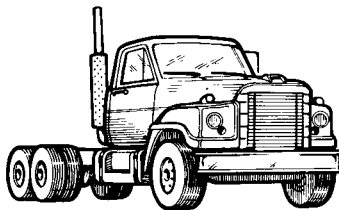

FLEETSTAR

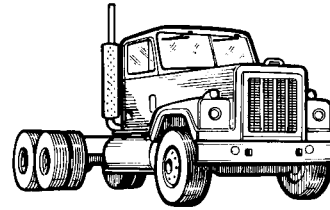

TRANSTAR CONVENTIONAL (4200, 4300)

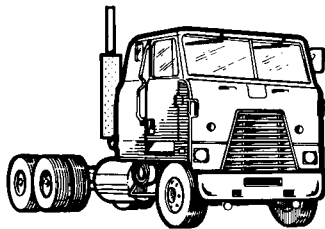

TRANSTAR COE (4700)

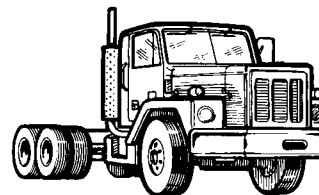

PAYSTAR (5000)

NAVISTAR

1300A, 1300B, 1300C 4WD

Tie Rod Ends

Axle Rating Lbs.	Axle Code/Year	Part Number/ Location	Stud Center to Rod End	OEM Reference	Notes
	1965-68	E-4636 Roadside	3.875"	219403R91	w/FA52 axle.

1300D 4WD

Tie Rod Ends

Axle Rating Lbs.	Axle Code/Year	Part Number/ Location	Stud Center to Rod End	OEM Reference	Notes
	1967-69	E-4636 Roadside	3.875"	219403R91	w/FA52 axle.

1310 4WD

Tie Rod Ends

Axle Rating Lbs.	Axle Code/Year	Part Number/ Location	Stud Center to Rod End	OEM Reference	Notes
	1972-73	E-4636 Roadside	3.875"	219403R91	w/FA52 axle.

3700, 3800, 3900

King Pin Kits

Axle Rating Lbs.	Axle Code/Year	Part Number/ Bushing Type	King Pin Size	Type	OEM Reference	Notes
6000	I60S (02ADA), I80S (02ADB)	E-6198B Bronze	1.359" x 7.970"	B	1660271C92	
8000	I60S (02ADA), I80S (02ADB)	E-6198B Bronze	1.359" x 7.970"	B	1660271C92	
10000, 12000	I100S, I120S	E-9941B Bronze	1.921" x 9.87"	B	1668411C91	
10000	I140S	E-9942B Bronze	2.046" x 10.120"	B	1668412C91	
16000	FA231 (02231)	E-4458B Bronze	1.999" x 11.212"	B	474520C91	Meritor axle FL941.
		E-4458C Composite			597258C91	

Tie Rod Ends

Axle Rating Lbs.	Axle Code/Year	Part Number/ Location	Stud Center to Rod End	OEM Reference	Notes
10000	I100S (02ADC)	E-4615 Curbside	5.44"	507838C91	w/126"-225" WB.
		E-4614 Roadside		507837C91	
		E-4631 Curbside	9.188"	1649638C91	w/226"-280" WB.
		E-4630 Roadside		1649637C91	
12000	FA082 (02EY8)	E-4611 Curbside	4.875"	110363R92	Fabco SDA12.
		E-4610 Roadside		110362R92	
	FA083 (02083)	E-4611 Curbside		110363R92	
		E-4610 Roadside		110362R92	
	I120S (02ADD)	E-4615 Curbside	5.44"	507838C91	w/126"-225" WB.
		E-4614 Roadside		507837C91	
		E-4631 Curbside	9.188"	1649638C91	w/226"-280" WB.
		E-4630 Roadside		1649637C91	
16000	FA231 (02231)	E-9879 Curbside	7.37"	590583C91	FL941 w/disc wheels.
		E-9880 Roadside		590584C91	

Drag Links

Axle Rating Lbs.	Axle Code/Year	Part Number	Stud Center to Stud Center	OEM Reference	Notes
		E-9911	17.68"	1661437C91	

NAVISTAR

4600, 4700, 4800, 4900

King Pin Kits

Axle Rating Lbs.	Axle Code/Year	Part Number/ Bushing Type	King Pin Size	Type	OEM Reference	Notes
6000	I60S (02ADA), I80S (02ADB)	E-6198B Bronze	1.359" x 7.970"	B	1660271C92	
8000	I60S (02ADA), I80S (02ADB)	E-6198B Bronze	1.359" x 7.970"	B	1660271C92	
10000	I100S (02ADC)	E-9941B Bronze	1.921" x 9.87"	B	1668411C91	
12000	I120S (02ADD)	E-9941B Bronze	1.921" x 9.87"	B	1668411C91	
14000	I140S (02ADE)	E-9942B Bronze	2.046" x 10.120"	B	1668412C91	
16000	FA231 (02231)	E-4458B Bronze E-4458C Composite	1.999" x 11.212"	B	474520C91 597258C91	Meritor FL941
16000, 18000, 20000	I160S (02ADH), I200S (02ADK)	E-11785B Bronze	2.046" x 11.00"	B	1685405C91	

Tie Rod Ends

Axle Rating Lbs.	Axle Code/Year	Part Number/ Location	Stud Center to Rod End	OEM Reference	Notes	
10000	I100S (02ADC)	E-4615 Curbside	5.44"	507838C91	w/126"-225" WB.	
		E-4614 Roadside		507837C91		
		E-4631 Curbside	9.188"	1649638C91	w/226"-280" WB.	
		E-4630 Roadside		1649637C91		
12000	FA082 (02EYB), FA083 (02083)	E-4611 Curbside	4.875"	110363R92	Fabco SDA12.	
		E-4610 Roadside		11036R92		
	I120S (02ADD)	E-4615 Curbside	5.44"	507838C91	w/126"-225" WB.	
		E-4614 Roadside		507837C91		
		E-4631 Curbside	9.188"	1649638C91	w/226"-280" WB.	
		E-4630 Roadside		1649637C91		
14000	I140S (02ADE)	E-4615 Curbside	5.44"	507838C91		
		E-4614 Roadside		507837C91		
	SDA14	E-4611 Curbside	4.875"	110363R92		
		E-4610 Roadside		110362R92		
16000	FA231 (02231)	E-4629 Curbside	7.37"	590583C91	w/Disc wheels.	
		E-4628 Roadside		590584C91		
	FA231 (02231), FL941	E-4617 Curbside	5.75"	969056R91		
		E-4616 Roadside		969055R91		
		E-4629 Curbside	7.37"	590583C91		
		E-4628 Roadside		590584C91		
	I160S (02ADH)	E-6856 Curbside	12.688"		w/ABS brakes.	
		E-6857 Roadside				
		E-6856 Curbside			179" and up WB.	
		E-6857 Roadside				
18000	I180S (02ADJ)	E-6856 Curbside	12.688"		179" and up WB.	
		E-6857 Roadside				
20000	I200S (02ADK)	E-4617 Curbside	5.75"	969056R91		
		E-4616 Roadside		969055R91		
		E-6856 Curbside	12.688"			179" and up WB.
		E-6857 Roadside				

Drag Links

Axle Rating Lbs.	Axle Code/Year	Part Number	Stud Center to Stud Center	OEM Reference	Notes
		E-11463	17.47"	1661867C91	4600LP/UH code 05PRG only.
		E-9911	17.68"	1661437C91	Codes 05PRH, 05PRJ, 05PSA.

King Pin Kits

Axle Rating Lbs.	Axle Code/Year	Part Number/ Bushings Type	King Pin Size	Type	OEM Reference	Notes
6000, 8000	I60S (02ADA), I80S (02ADB)	E-6198B Bronze	1.359" x 7.970"	B	1660271C92	
9000	I100S, I120S, 02A, 02ADC, 02ADN	E-9941B Bronze	1.921" x 9.87"	B	FAK5455	
10000	I100S, I120S, 02A, 02ADC, 02ADN	E-9941B Bronze	1.921" x 9.87"	B	FAK5455	
11000	I100S, I120S, 02A, 02ADC, 02ADN	E-9941B Bronze	1.921" x 9.87"	B	FAK5455	
12000	E1200I (02AED)	E-11394B Bronze	1.794" x 9.02"	B	823078	
	I120S (02ADD)	E-9941B Bronze	1.921" x 9.87"		FAK5455	
14000	I140S (02ADE)	E-9942B Bronze	2.046" x 10.120"	B	FAK5456	
16000	FA231 (02231)	E-4458B Bronze	1.999" x 11.212"	B	474520C91	Double Drawkey.
		E-4458C Composite			597258C91	

Tie Rod Ends

Axle Rating Lbs.	Axle Code/Year	Part Number/ Location	Stud Center to Rod End	OEM Reference	Notes
10000	I100S (02ADC)	E-4615 Curbside	5.44"	507838C91	w/126"-225" WB.
		E-4614 Roadside		507837C91	
		E-4631 Curbside	9.188"	1649638C91	w/226"-280" WB.
		E-4630 Roadside		1649637C91	
12000	E1200I (02AED)	E-10137 Curbside	6.00"	817019	
		E-10138 Roadside		817018	
	FA082 (02EYB), FA083 (02083)	E-4611 Curbside	4.875"	110363R92	Fabco SDA12.
		E-4610 Roadside		110362R92	
	I120S (02ADD)	E-4615 Curbside	5.44"	507838C91	w/126"-225" WB.
		E-4614 Roadside		507837C91	
E-4631 Curbside		9.188"	1649638C91	w/226"-280" WB.	
E-4630 Roadside			1649637C91		
16000	FA231 (02231)	E-9879 Curbside	7.37"	590583C91	w/Disc wheels.
		E-9880 Roadside		590584C91	
		E-6856 Curbside	12.688"	1668480C91	w/Cast wheels.
		E-6857 Roadside		1668479C91	

Drag Links

Axle Rating Lbs.	Axle Code/Year	Part Number	Stud Center to Stud Center	OEM Reference	Notes
		E-11463	17.47"	1661867C91	7100 w/05PRG.
		E-9911	17.68"	1661437C91	w/05PRH, 05PRJ, 05PSH, w/Power or manual steering.



an **ArvinMeritor**™ brand

NAVISTAR

8100, 8200, 8300 (Built 1989 and Later)

King Pin Kits

Axle Rating Lbs.	Axle Code/Year	Part Number/ Bushing Type	King Pin Size	Type	OEM Reference	Notes
10000	I100S (02ADC)	E-9941B Bronze	1.921" x 9.87"	B	FAK5455	
12000	E1200I (02AED)	E-11394B Bronze	1.794" x 9.02"	B	823078	
	EFA12 (02250)	E-4696B Bronze	1.625" x 9.195"	A	FAK4572	
		E-4696C Composite				
	FA226, FF941, FF942, 02226, 02227	E-4468B Bronze	1.794" x 10.392"	B	FAK4564	
		E-4694C Composite				
	FA337, I120, 02337	E-4693B Bronze	1.609" x 9.660"			1658934C93
		E-6875C Composite				
FF961 (02ARA)	E-6199B Bronze	1.794" x 10.392"				
	E-6199C Composite					
I120S, 02ADD, 02ADG	E-9941B Bronze	1.921" x 9.87"			FAK5453	
13200	EFA12 (02AEA)	E-4696B Bronze	1.625" x 9.195"	A	FAK4572	
		E-4696C Composite				
	FA227 (02227)	E-4468B Bronze	1.794" x 10.392"	B		549800C91
		E-4694C Composite				597556C91
		E-6199C Composite				1665531C91
	FA343, I132, 02343	E-4693B Bronze	1.609" x 9.660"			1658934C93
		E-6875C Composite				
	FF942 (02227)	E-4694C Composite	1.794" x 10.392"			597556C91
		E-6199B Bronze				
		E-6199C Composite				1665531C91
14000	I140S (02ADE)	E-9942B Bronze	2.046" x 10.120"	B	FAK5456	
16000	FA231 (02231), FA232 (02232), FA233 (02233), FL941 (02231)	E-4458B Bronze	1.999" x 11.212"	B	474520C91	
		E-4458C Composite			597258C91	
18000	FA231 (02231), FA232 (02232), FA233 (02233), FL941 (02232)	E-4458B Bronze	1.999" x 11.212"	B	474520C91	
		E-4458C Composite			597258C91	
20000	FA231 (02231), FA232 (02232), FA233 (02233), FL941 (02233)	E-4458B Bronze	1.999" x 11.212"	B	474520C91	
		E-4458C Composite			597258C91	

If you detect any **errors** in this Catalog, please let us know.

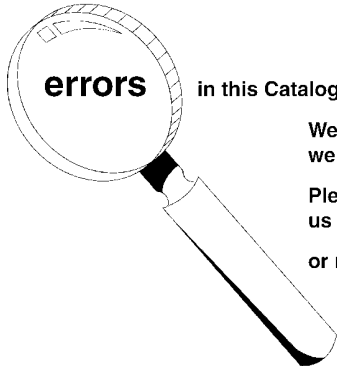

We want the information to be as accurate as possible; we appreciate your help in making it so.

Please e-mail any comments/suggestions/corrections to us at: catalogfeedback@arvinmeritor.com

or mail to: **Euclid Industries, LLC**
Attn: Catalog Dept.
7975 Dixie Highway
Florence, KY 41042-2754

8100, 8200, 8300 (Built 1989 and Later) (Continued)

Tie Rod Ends

Axle Rating Lbs.	Axle Code/Year	Part Number/ Location	Stud Center to Rod End	OEM Reference	Notes
10000	I100S (02ADC)	E-4615 Curbside	5.44"	507838C91	w/126" -225" WB.
		E-4614 Roadside		507837C91	
		E-4631 Curbside	9.188"	1649638C91	w/226" -280" WB.
		E-4630 Roadside		1649637C91	
12000	FF961 (02ARA)	E-4615 Curbside	5.44"	507838C91	
		E-4614 Roadside		507837C91	
	I120S (02ADD)	E-4615 Curbside	5.44"	507838C91	w/126" -225" WB.
		E-4614 Roadside		507837C91	
		E-4631 Curbside	9.188"	1649638C91	w/226" -280" WB.
		E-4630 Roadside		1649637C91	
	I120S (02ADG)	E-9952 Curbside	9.438"	1668410C91	
		E-9951 Roadside		1668409C91	
13200	FA227 (02227), FF942 (02227)	E-4615 Curbside	5.44"	507838C91	
		E-4614 Roadside		507837C91	
14000	I140S (02ADE)	E-4615 Curbside	5.44"	1668408C91	
		E-4614 Roadside		1668407C91	
16000	FA231 (02231), FA233 (02233), FL941 (02231)	E-4629 Curbside	7.37"	590583C91	
		E-4628 Roadside		590584C91	
18000	FA231 (02231), FA232 (02232), FA233 (02233), FL941 (02232)	E-4629 Curbside	7.37"	590583C91	
		E-4628 Roadside		590584C91	
20000	FA231 (02231), FA232 (02232), FA233 (02233), FL941 (02233)	E-4629 Curbside	7.37"	590583C91	
		E-4628 Roadside		590584C91	

Drag Links

Axle Rating Lbs.	Axle Code/Year	Part Number	Stud Center to Stud Center	OEM Reference	Notes
		E-9911	17.68"	1661437C91	

9200

King Pin Kits

Axle Rating Lbs.	Axle Code/Year	Part Number/ Bushing Type	King Pin Size	Type	OEM Reference	Notes
10000	I100S	E-9941B Bronze	1.921" x 9.87"	B	1668411C91	
12000	EFA12 (02250)	E-4696B Bronze	1.625" x 9.195"	A	FAK4572	
	FF961 (02ARA)	E-6199B Bronze	1.794" x 10.392"	B	1665531C91	
E-6199C Composite						
13200	FF942 (02227)	E-6199B Bronze	1.794" x 10.392"	B	1665531C91	
		E-6199C Composite				
14000	I140S	E-9942B Bronze	2.046" x 10.120"	B	1668412C91	
16000, 18000	FL941 (02231), (02232)	E-4458C Composite	1.999" x 11.212"	B	597258C91	
		I160S (02ADH), I180S (02ADJ), I200S (02ADK)	E-11785B Bronze		2.046" x 11.00"	

NAVISTAR

9200 (Continued)

Tie Rod Ends

Axle Rating Lbs.	Axle Code/Year	Part Number/Location	Stud Center to Rod End	OEM Reference	Notes
12000	EFA12 (02250), FF961 (02ARA)	E-4615 Curbside	5.44"	507838C91	w/o 04AZA ABS brakes, 154"-188" WB. 189" WB and up.
		E-4614 Roadside		507837C91	
	I120S (02ADD)	E-4615 Curbside	9.188"	507838C91	
		E-4614 Roadside		507837C91	
		E-4631 Curbside		1649638C91	
		E-4630 Roadside		1649637C91	
13200	FF942 (02227)	E-4615 Curbside	5.44"	507838C91	
		E-4614 Roadside		507837C91	
14000	I140S (02ADE)	E-4615 Curbside	5.44"	1668408C91	
		E-4614 Roadside		1668407C91	
		E-9952 Curbside	9.438"	1668410C91	
		E-9951 Roadside		1668409C91	
16000, 18000	E1200I (02AED), E1320I (02AEG)	E-10137 Curbside	6.00"	817019	
		E-10138 Roadside		817018	
	FL941 (02231), (02232)	E-4629 Curbside	7.37"	486355C91	
		E-4628 Roadside		486354C91	

9300, 9400

King Pin Kits

Axle Rating Lbs.	Axle Code/Year	Part Number/ Bushings Type	King Pin Size	Type	OEM Reference	Notes
12000	EFA12 (02250)	E-4696B Bronze	1.625" x 9.195"	A	ETN0806355	
		E-4696C Composite				
	FA223 (02223)	E-6199C Composite	1.794" x 10.392"	B	1665531C91	
	FA234 (02234)	E-4595B Bronze	1.607" x 9.375"		577684C91	
	FA337 (02337), FA339 (02339)	E-6875C Composite	1.609" x 9.660"		1658934C92	
		FF961 (02ARA)	E-6199C Composite		1.794" x 10.392"	
I100S, I120S	E-9941B Bronze	1.921" x 9.87"	1668411C91			
13200	FA227 (02227)	E-4694C Composite	1.794" x 10.392"	B	597556C91	
		E-6199B Bronze				
		E-6199C Composite			1665531C91	
	FA343 (02343)	E-6875C Composite	1.609" x 9.660"	1658934C92		
14000	I140S (02ADE)	E-9942B Bronze	2.046" x 10.120"	B	1668412C91	
14600	FG940 (02ARG)	E-4695C Composite	1.794" x 10.392"	B		
		E-6868B Bronze				
16000	FA231 (02231), FA232 (02232)	E-4458B Bronze	1.999" x 11.212"	B	474520C91	
		E-4458C Composite			597258C91	
16000, 18000	I160S (02ADH), I180S (02ADJ), I200S (02ADK)	E-11785B Bronze	2.046" x 11.00"	B	1685405C91	
18000	FA231 (02231), FA232 (02232)	E-4458B Bronze	1.999" x 11.212"	B	474520C91	
		E-4458C Composite			597258C91	



an **ArvinMeritor**™ brand

Tie Rod Ends

Axle Rating Lbs.	Axle Code/Year	Part Number/ Location	Stud Center to Rod End	OEM Reference	Notes	
12000	EFA12 (02250), FA226 (02226), FF931 (02226), FF961 (02ARA)	E-4615 Curbside	5.44"	507838C91		
		E-4614 Roadside		507837C91		
	FA234 (02234)	E-6848 Curbside	10.50"	577683C91		Meritor axle FF971.
		E-6847 Roadside		577682C91		
	FA337 (02337), FA339 (02339)	E-4631 Curbside	9.188"	1649638C91		
		E-4630 Roadside		1649637C91		
	I120S (02ADD)	E-4615 Curbside	5.44"	507838C91		w/1659687C91 axle.
				E-4614 Roadside		
		E-4631 Curbside	9.188"	1649638C91		w/1659688C91 axle.
				E-4630 Roadside		
13200	FA227 (02227)	E-4615 Curbside	5.44"	507838C91	Meritor axle FF942.	
				E-4614 Roadside		507837C91
	I132 (02343)	E-6136 Curbside	10.84"	1658947C91		
				E-6135 Roadside		1658946C91
14000	I140S (02ADE)	E-4615 Curbside	5.44"	1668408C91	140" through 188" WB.	
				E-4614 Roadside	1668407C91	154" through 188" WB.
		E-9952 Curbside	9.438"	1668410C91	189" WB and up.	
				E-9951 Roadside		1668409C91
14600	FG941 (02ARG)	E-4615 Curbside	5.44"	507838C91		
		E-4614 Roadside		507837C91		
16000, 18000	E1200I (02AED), E1320I (02AEG)	E-10137 Curbside	6.00"	817019		
		E-10138 Roadside		817018		
16000	FA231 (02231)	E-4629 Curbside	7.37"	590583C91	Meritor axle FL931.	
				E-4628 Roadside		590584C91
	FA232 (02232)	E-4629 Curbside		590583C91	Meritor axle FL941.	
				E-4628 Roadside		590584C91
18000	FA231 (02231), FA232 (02232)	E-4628 Roadside	7.37"	590584C91	Meritor axle FL931.	
		E-4629 Curbside		590583C91		

Drag Links

Axle Rating Lbs.	Axle Code/Year	Part Number	Stud Center to Stud Center	OEM Reference	Notes
		E-9948	12.375" Stud center to rod end	1658897C91	Drag link end for codes 05PRJ, 3600, 05PRK.3601.
		E-5386	16.27"	503523C94	Includes 506684C91 (E-4629) end, and 1658897C91 (E-9948) long end.

S.O.S.

Special Order Service

Can't find it?

Trouble sourcing products?

Need assistance?

Let Euclid's Special Order Service (**S.O.S.**) help you find your parts.

Euclid's position as the market leader provides you access to a comprehensive array of truck parts products from the industry's leading manufacturers. Through Euclid, these entire product lines are available to you just by placing a phone call to Euclid's S.O.S. Department at 866-238-2543 (option 2) in the U.S. or 800-387-3889 in Canada.

NAVISTAR

9600, 9700

King Pin Kits

Axle Rating Lbs.	Axle Code/Year	Part Number/ Bushing Type	King Pin Size	Type	OEM Reference	Notes
10800	FA341 (02341)	E-6875C Composite	1.609" x 9.660"	B	1658934C92	
12000	EFA12 (02250)	E-4696B Bronze	1.625" x 9.195"	A	ETN0806355	
		E-4696C Composite				
	FA223 (02223), FA226 (02226)	E-4468B Bronze	1.794" x 10.392"	B	549800C91	
		E-4694C Composite			597556C91	
		E-6199B Bronze				
		E-6199C Composite			1665531C91	
	FA234 (02234)	E-4595B Bronze	1.607" x 9.375"		577684C91	
	FA339 (02339)	E-6875C Composite	1.609" x 9.660"		1658934C92	
	FF931 (02223)	E-4468B Bronze	1.794" x 10.392"		549800C91	
	FF941 (02226)	E-4694C Composite			597556C91	
		E-6199B Bronze				
		E-6199B Bronze				
		E-6199C Composite			1665531C91	
	FF961 (02ARA)	E-6199B Bronze				
E-6199B Bronze						
E-6199C Composite		1665531C91				
I120 (02337)	E-6875C Composite	1.609" x 9.660"		1658934C92		
13200	FA227 (02227)	E-4468B Bronze	1.794" x 10.392"	B	549800C91	Meritor axle FF931.
		E-4694C Composite			597556C91	
		E-6199B Bronze				
		E-6199C Composite			1665531C91	Meritor axle FF931.
I132 (02343)	E-6875C Composite	1.609" x 9.660"		1658934C92		
16000	FA231 (02231), FA232 (02232)	E-4458B Bronze	1.999" x 11.212"	B	474520C91	
		E-4458C Composite			597258C91	
18000	FA231 (02231), FA232 (02232)	E-4458B Bronze	1.999" x 11.212"	B	474520C91	
		E-4458C Composite			597258C91	
24000	FA248 (02248)	E-6875C Composite	1.609" x 9.660"	B	1658934C92	

If you detect any **errors** in this Catalog, please let us know.

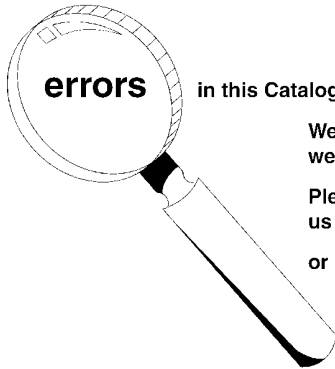

We want the information to be as accurate as possible;
we appreciate your help in making it so.

Please e-mail any comments/suggestions/corrections to
us at: catalogfeedback@arvinmeritor.com

or mail to: **Euclid Industries, LLC**
Attn: Catalog Dept.
7975 Dixie Highway
Florence, KY 41042-2754

Axle Rating Lbs.	Axle Code/Year	Part Number/ Location	Stud Center to Rod End	OEM Reference	Notes
10800	FA341 (02341)	E-4631 Curbside	9.188"	1649638C91 1649637C91	
12000	EFA12 (02250), FF931 (02223), FF941 (02226), FF961 (02ARA), FA223 (02223), FA226 (02226)	E-4615 Curbside E-4614 Roadside	5.44"	507838C91 507837C91	
	FA234 (02234)	E-6848 Curbside E-6847 Roadside	10.50"	577683C91 577682C91	Meritor FF971.
	FA339 (02339)	E-5469 Roadside E-4631 Curbside E-4630 Roadside	5.44" 9.188"	506662C91 506661C91 1649638C91 1649637C91	Drop end. Straight end, greaseable type.
	FA340 (02340)	E-4631 Curbside E-4630 Roadside		1649638C91 1649637C91	
	I120 (02337)	E-5470 Curbside E-5469 Roadside E-4631 Curbside E-4630 Roadside	5.44" 9.188"	506662C91 506661C91 1649638C91 1649637C91	Drop end. Straight end, greaseable type.
	I120S (02ADD, 02ADG)	E-4615 Curbside E-4614 Roadside E-9952 Curbside E-9951 Roadside	5.44" 9.438"	507838C91 507837C91 1668410C91 1668409C91	w/04AZA ABS brakes /9700.
13200	FA227 (02227)	E-4614 Roadside	5.44"	507838C91 507837C91	
	I132 (02343)	E-5470 Curbside E-5469 Roadside E-4631 Curbside	9.188"	506662C91 506661C91 1649638C91 1649637C91	Dropped I-beam. Straight end, greaseable type.
		E-6136 Curbside E-6135 Roadside	10.84"	1658947C91 1658946C91	Drop end, greaseable type.
14000	I140S	E-4615 Curbside E-4614 Roadside E-9952 Curbside E-9951 Roadside	5.44" 9.438"	507838C91 507837C91 1668410C91 1668409C91	110" WB and up/9600 w/04AZA ABS brakes /9700.
16000	FA231 (02231), FA232 (02232)	E-4629 Curbside E-4628 Roadside	7.37"	590583C91 590584C91	
18000	FA231 (02231), FA232 (02232)	E-4628 Roadside	7.37"	590583C91 590584C91	
24000	FA248 (02248)	E-4631 Curbside E-4630 Roadside	9.188"	1649638C91 1649637C91	

Drag Links

Axle Rating Lbs.	Axle Code/Year	Part Number	Stud Center to Stud Center	OEM Reference	Notes
		E-9948	12.375" Stud center to rod end	1658897C91	Drag link end for codes 05PRJ.4510, 05PSA.4518.

NAVISTAR

Additional Navistar Axles

King Pin Kits

Axle Rating Lbs.	Axle Code/Year	Part Number/ Bushing Type	King Pin Size	Type	OEM Reference	Notes	
5000	FA71 (02071)	E-4460B Bronze	1.359" x 7.968"	A	473695C91	2WD	
	I50	E-4460B Bronze					
5500	FA89 (02089)	E-4431B Bronze	1.234" x 7.656"	A	61556R91	2WD	
6000	FA73 (02073), FA74 (02074), I60	E-4460B Bronze	1.359" x 7.968"	A	473695C91	2WD	
7000	FA95 (02095)	E-4438B Bronze	1.234" x 7.438"	B		2WD, Meritor axle FC901.	
		E-4438N Nylon					
	FA97 (02097)	E-4431B Bronze	1.234" x 7.656"	A	61556R91	2WD	
7500	FA101 (02101), FA103 (02103)	E-4460B Bronze	1.359" x 7.968"	A	473695C91	2WD	
	FA65 (02065)	E-4431B Bronze					
	FA80 (02080), FA91 (02091), FA98 (02098), FA99 (02099)	E-4431B Bronze					
	I75	E-4460B Bronze					
9000	FA100 (02100), FA102 (02102), FA105 (02105)	E-4441B Bronze	1.434" x 8.500"	B	303136C92	2WD Meritor axle FD900.	
	FA201 (02201)	E-4442B Bronze					
	FA208 (02208)	E-4441B Bronze					
	FA209 (02209)	E-4441B Bronze					
	I90	E-4697B Bronze					
		E-4693B Bronze					
10800	I108	E-4697B Bronze	1.609" x 9.160"	B	586809C91	For steering code 02309.	
		E-4693B Bronze				1.609" x 9.660"	588808C91
11000	FA112 (02112), FA113 (02113)	E-4449B Bronze	1.607" x 8.740"	B	229265R91	2WD Meritor axle FE970.	
12000	FA110 (02110), FA111 (02111)	E-4434B Bronze	9.750"	D	69576R92	Tapered pin. 2WD Meritor axle FE900.	
		E-4434N Bronze, Nylon					
	FA115 (02115)	E-4434B Bronze					
			E-4434N Bronze, Nylon				Tapered pin. 2WD exc. model DC0200 w/diesel eng.
	FA211 (02211)	E-4442B Bronze	1.794" x 9.120"	B	303139C92	2WD	
	FA212 (02212), FA213 (02213)	E-4442B Bronze					
	FA215 (02215)	E-4442B Bronze					
	FA218 (02218)	E-4442B Bronze					
	FA219 (02219)	E-4442B Bronze					
	FA225 (02225)	E-4450B Bronze					
	FA226 (02226)	E-4468B Bronze	1.794" x 10.410"		452344C91	2WD Meritor axle FF921.	
		E-4694C Composite			549800C91	2WD Meritor axle FF931.	
	FA228 (02228), FA229 (02229)	E-4450B Bronze	1.794" x 10.410"		597556C91	Meritor axle FF921.	
FA234 (02234)	E-4595B Bronze	1.607" x 9.375"		452344C91	Meritor axle FF921.		
I120	E-4697B Bronze	1.609" x 9.160"		577684C91	Meritor axle FF971.		
	E-4693B Bronze	1.609" x 9.660"		586809C91	For steering code 02309.		
13000	FA401 (02401)	E-4693B Bronze	1.609" x 9.660"	B	588808C91	Exc. steering code 02309.	
		E-4693B Bronze	1.609" x 9.660"	B	588808C91	Paystar series.	
16000	FA136 (02136), FA137 (02137)	E-4454B Bronze	1.999" x 11.040"	B	303140C92	2WD Meritor axle FH901.	
		E-4454N Nylon					
	FA231 (02231), FA237 (02237)	E-4458B Bronze					
		E-4458C Composite	1.999" x 11.212"		474520C91	2WD Meritor axle FL931.	
					597258C91		

Additional Navistar Axles (Continued)

King Pin Kits (Continued)

Axle Rating Lbs.	Axle Code/Year	Part Number/ Bushing Type	King Pin Size	Type	OEM Reference	Notes
18000	FA182 (02182)	E-4454B Bronze	1.999" x 11.040"	B	303140C92	2WD Meritor axle FL901.
		E-4454N Nylon				
	FA232 (02232), FA238 (02238)	E-4458B Bronze	1.999" x 11.212"		474520C91	2WD Meritor axle FL931.
		E-4458C Composite				
20000	FA183 (02183)	E-4454B Bronze	1.999" x 11.040"	B	303140C92	2WD Meritor axle FL901.
		E-4454N Nylon				
	FA233 (02233), FA239 (02239)	E-4458B Bronze	1.999" x 11.212"		474520C91	2WD Meritor axle FL931.
		E-4458C Composite				

Tie Rod Ends

Axle Rating Lbs.	Axle Code/Year	Part Number/ Location	Stud Center to Rod End	OEM Reference	Notes
3500	FA18 (02018)	E-4635 Curbside	3.50"	894145R91	4WD To 1968 Dana axle model 44.
		E-4634 Roadside		894144R91	
4700	FA18 (02018)	E-4635 Curbside	3.50"	894145R91	4WD To 1968 Dana axle model 44.
		E-4634 Roadside		894144R91	
5000	FA71 (02071)	E-4605 Curbside	4.438"	450062C91	2WD
		E-4604 Roadside		450063C91	
	I50	E-4605 Curbside		450062C91	
		E-4604 Roadside		450063C91	
5500	FA60 (02060)	E-4601 Curbside	3.875"	263499C91	2WD w/Manual steering.
		E-4600 Roadside		263498C91	
	FA68 (02068), FA70 (02070), FA72 (02072), FA89 (02089)	E-4601 Curbside		263499C91	
		E-4600 Roadside		263498C91	
6000	FA51 (02051)	E-4636 Roadside	3.875"	219403R91	4WD Dana axle.
	FA52 (02052)	E-4636 Roadside			4WD Dana axle model 70F.
	FA69 (02069)	E-4601 Curbside	4.438"	263499C91	2WD
		E-4600 Roadside		263498C91	
	FA73 (02073), FA74 (02074)	E-4605 Curbside	4.438"	450062C91	
		E-4604 Roadside		450063C91	
I60	E-4605 Curbside	4.438"	450062C91		
	E-4604 Roadside		450063C91		
7000	FA97 (02097)	E-4601 Curbside	3.875"	263499C91	2WD
		E-4600 Roadside		263498C91	
7500	FA101 (02101), FA103 (02103)	E-4605 Curbside	4.438"	450062C91	2WD
		E-4604 Roadside		450063C91	
	FA65 (02065)	E-4601 Curbside	3.875"	263499C91	2WD w/Manual steering.
		E-4600 Roadside		263498C91	
	FA80 (02080), FA98 (02098), FA99 (02099)	E-4601 Curbside	3.875"	263499C91	2WD
		E-4600 Roadside		263498C91	
	FA90 (02090)	E-4637 Curbside	3.875"	219404R91	2WD After chassis no. FA48391.
		E-4636 Roadside		219403R91	
FA91 (02091)	E-4601 Curbside	3.875"	263499C91	2WD Exc. CO1950 w/power steering.	
	E-4600 Roadside		263498C91		
I75	E-4605 Curbside	4.438"	450062C91		
	E-4604 Roadside		450063C91		

NAVISTAR

Additional Navistar Axles (Continued)

Tie Rod Ends (Continued)

Axle Rating Lbs.	Axle Code/Year	Part Number/ Location	Stud Center to Rod End	OEM Reference	Notes	
9000	FA100 (02100), FA102 (02102), FA105 (02105)	E-4611 Curbside	4.875"	110363R92	2WD Meritor axle FD900.	
		E-4610 Roadside		110362R92		
	FA201 (02201)	E-4611 Curbside		110363R92	2WD	
		E-4610 Roadside		110362R92		
	FA208 (02208), FA209 (02209)	E-4611 Curbside		110363R92		
		E-4610 Roadside		110362R92		
11000	FA112 (02112), FA113 (02113)	E-6848 Curbside	10.50"	577683C91	2WD Meritor axle FE970.	
		E-6847 Roadside		577682C91		
12000	FA110 (02110), FA111 (02111)	E-4611 Curbside	4.875"	110363R92	2WD Meritor axle FE900.	
		E-4610 Roadside		110362R92	Meritor axle FE900.	
	FA115 (02115)	E-4611 Curbside		110363R92	2WD Exc. model DC0200 w/diesel engine.	
		E-4610 Roadside		110362R92		
	FA211 (02211)	E-4611 Curbside		110363R92	2WD	
		E-4610 Roadside		110362R92		
	FA212 (02212), FA213 (02213)	E-4611 Curbside		110363R92		
		E-4610 Roadside		110362R92		
	FA215 (02215)	E-4611 Curbside		110363R92		
		E-4610 Roadside		110362R92		
	FA218 (02218)	E-4611 Curbside		110363R92		
		E-4610 Roadside		110362R92		
	FA219 (02219)	E-4611 Curbside		110363R92		
		E-4610 Roadside		110362R92		
	FA225 (02225), FA228 (02228), FA229 (02229)	E-4615 Curbside		5.44"	507838C91	2WD Meritor axle FF221.
		E-4614 Roadside			507837C91	
E-4615 Curbside		507838C91	2WD Meritor axle FF931.			
E-4614 Roadside	507837C91					
FA234 (02234)	E-6848 Curbside	10.50"	577683C91	2WD Meritor axle FF971.		
	E-6847 Roadside		577682C91			
13000	FA401 (02401)	E-4617 Curbside	5.75"	969056R91	2WD Paystar series.	
		E-4616 Roadside		969055R91		
15000	FA132 (02132), FA133 (02133)	E-4611 Curbside	4.875"	110363R92	2WD Meritor axle FG900.	
		E-4610 Roadside		110362R92		
16000	FA136 (02136), FA137 (02137)	E-4617 Curbside	5.75"	969056R91	2WD Meritor axle FH901.	
		E-4616 Roadside		969055R91		
	FA231 (02231), FA237 (02237)	E-4628 Roadside	7.37"	486354C91	2WD Meritor Axle FL931.	
		E-4629 Curbside		486355C91	2WD Meritor axle FL931.	
18000	FA182 (02182)	E-4617 Curbside	5.75"	969056R91	2WD Meritor axle FL901.	
		E-4616 Roadside		969055R91		
	FA194 (02194)	E-4619 Roadside		491665C91	4WD Meritor drive FDS1807. 1.25"-12 RH thread.	
		E-4642 Curbside		491666C91	4WD Meritor drive FDS1807. 1.25"-16 RH thread.	
		E-6858 Roadside		592872C91	4WD Meritor drive FDS1807. 1.25"-18 RH thread.	
	FA232 (02232), FA238 (02238)	E-4629 Curbside		7.37"	486355C91	2WD Meritor axle FL931.
		E-4628 Roadside			486354C91	
20000	FA183 (02183)	E-4617 Curbside	5.75"	969056R91	2WD Meritor axle FL901.	
		E-4616 Roadside		969055R91		
	FA233 (02233), FA239 (02239)	E-4629 Curbside	7.37"	486355C91	2WD Meritor axle FL931.	
		E-4628 Roadside		486354C91		

Additional Navistar Axles (Continued)

Tie Rod Ends (Continued)

Axle Rating Lbs.	Axle Code/Year	Part Number/ Location	Stud Center to Rod End	OEM Reference	Notes
21000	FA195 (02195)	E-4619 Roadside	5.75"	491665C91	4WD Meritor drive FDS1807. 1.25"-12 RH thread.
		E-4642 Curbside		491666C91	4WD Meritor drive FDS1807. 1.25"-16 RH thread.
		E-6858 Roadside		592872C91	4WD Meritor drive FDS1807. 1.25"-18 RH thread.

C1200 4WD

Tie Rod Ends

Axle Rating Lbs.	Axle Code/Year	Part Number/ Location	Stud Center to Rod End	OEM Reference	Notes
	1967-69	E-4635 Curbside	3.50"	894145R91	w/FA18 axle.
		E-4634 Roadside		894144R91	

CO/COF9670, Eagle

King Pin Kits

Axle Rating Lbs.	Axle Code/Year	Part Number/ Bushing Type	King Pin Size	Type	OEM Reference	Notes
10800	FA341 (02341)	E-4462B Bronze	1.609" x 9.660"	A	493094C92	
12000	FA223 (02223)	E-4468B Bronze	1.794" x 10.392"	B	549800C91	Meritor axle FF941.
		E-4694C Composite			597556C91	
	FA226 (02226)	E-4468B Bronze	1.607" x 9.375"		549800C91	Meritor axle FF931.
		E-4694C Composite			597556C91	
	FA234 (02234)	E-4595B Bronze	1.609" x 9.660"		577684C91	Meritor axle FF971. Center point steering.
	FA337 (02337), FA339 (02339)	E-4693B Bronze			588808C91	
16000	FA231 (02231)	E-4458B Bronze	1.999" x 11.212"	B	474520C91	Meritor axle FL931.
		E-4458C Composite			597258C91	
18000	FA232 (02232)	E-4458B Bronze	1.999" x 11.212"	B	474520C91	Meritor axle FL931.
		E-4458C Composite			597258C91	
24000	FA340 (02340)	E-4462B Bronze	1.609" x 9.660"	A	493094C92	Dual 12,000 lb. Navistar axles.

S.O.S.

Special Order Service

Can't find it?

Trouble sourcing products?

Need assistance?

*Let Euclid's Special Order Service (**S.O.S.**) help you find your parts.*

Euclid's position as the market leader provides you access to a comprehensive array of truck parts products from the industry's leading manufacturers. Through Euclid, these entire product lines are available to you just by placing a phone call to Euclid's S.O.S. Department at 866-238-2543 (option 2) in the U.S. or 800-387-3889 in Canada.

NAVISTAR

CO/COF9670, Eagle (Continued)

Tie Rod Ends

Axle Rating Lbs.	Axle Code/Year	Part Number/Location	Stud Center to Rod End	OEM Reference	Notes
10800	FA341 (02341)	E-4631 Curbside	9.188"	507835C91	Greaseable type.
		E-4630 Roadside		507836C91	
12000	FA223 (02223)	E-4615 Curbside	5.44"	507838C91	Meritor axle FF941.
		E-4614 Roadside		507837C91	
	FA226 (02226)	E-4615 Curbside	5.44"	507838C91	Meritor axle FF931.
		E-4614 Roadside		507837C91	
	FA234 (02234)	E-6848 Curbside	10.50"	577683C91	Meritor axle FF971. Center point steering.
		E-6847 Roadside		577682C91	
	FA337 (02337), FA339 (02339), FA340 (02340)	E-5470 Curbside	5.44"	506662C91	Drop end.
		E-5469 Roadside		506661C91	
E-4631 Curbside		9.188"	507836C91	Straight end, greaseable type.	
			E-4630 Roadside		507835C91
16000	FA231 (02231)	E-4629 Curbside	7.37"	486355C91	Meritor axle FL931.
		E-4628 Roadside		486354C91	
18000	FA232 (02232)	E-4629 Curbside	7.37"	486355C91	Meritor axle FL931.
		E-4628 Roadside		486354C91	
24000	FA340 (02340)	E-4631 Curbside	9.188"	507836C91	Greaseable type. Dual 12,000 lb. Navistar axles.
		E-4630 Roadside		507835C91	
24500	FA344 (02340)	E-4631 Curbside	9.188"	507836C91	
		E-4630 Roadside		507835C91	

Drag Links

Axle Rating Lbs.	Axle Code/Year	Part Number	Stud Center to Stud Center	OEM Reference	Notes
		E-4629	7.37" Stud center to rod end	581063C91	End only. Use with 503523C91 (E-5386).
		E-5386	16.27"	503523C91	Includes 581063C91 (E-4629) end.

CO4000, COF4000, COT4000

King Pin Kits

Axle Rating Lbs.	Axle Code/Year	Part Number/ Bushing Type	King Pin Size	Type	OEM Reference	Notes
12000	FA112 (02112)	E-4449B Bronze	1.607" x 8.740"	B	303138C92	Meritor axle FE970. Center point steering.
16000	FA136 (02136)	E-4454B Bronze	1.999" x 11.040"	B	303140C92	Meritor axle FH901.
		E-4454N Nylon				
18000	FA182 (02182)	E-4454B Bronze	1.999" x 11.040"	B	303140C92	Meritor axle FL901.
		E-4454N Nylon				

If you detect any **errors** in this Catalog, please let us know.

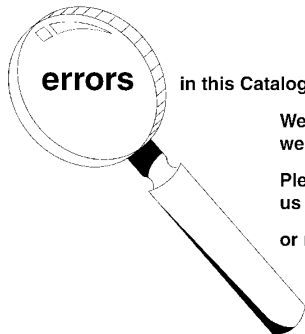

We want the information to be as accurate as possible; we appreciate your help in making it so.

Please e-mail any comments/suggestions/corrections to us at: catalogfeedback@arvinmeritor.com

or mail to: **Euclid Industries, LLC**
Attn: Catalog Dept.
7975 Dixie Highway
Florence, KY 41042-2754

CO4000, COF4000, COT4000 (Continued)

Tie Rod Ends

Axle Rating Lbs.	Axle Code/Year	Part Number/ Location	Stud Center to Rod End	OEM Reference	Notes
9000	FA109 (02109)	E-4631 Curbside	9.188"	377636C91	Greaseable type from 1970.
		E-4630 Roadside		377635C91	
12000	FA112 (02112)	E-6848 Curbside	10.50"	894050R93	Center point steering.
		E-6847 Roadside		894049R93	
	FA119 (02119)	E-4631 Curbside	9.188"	377636C91	Greaseable type from 1970.
		E-4630 Roadside		377635C91	
	FA215 (02215)	E-4611 Curbside	4.875"	110363R92	
		E-4610 Roadside		110362R92	
16000	FA136 (02136)	E-4617 Curbside	5.75"	969056R91	Meritor axle FH901.
		E-4616 Roadside		969055R91	
18000	FA182 (02182)	E-4617 Curbside	5.75"	969056R91	Meritor axle FL901.
		E-4616 Roadside		969055R91	

COF5870

King Pin Kits

Axle Rating Lbs.	Axle Code/Year	Part Number/ Bushing Type	King Pin Size	Type	OEM Reference	Notes
16000	FA231 (02231)	E-4458B Bronze	1.999" x 11.212"	B	474520C91	Meritor axle FH901.
		E-4458C Composite			597258C91	
	FL941 (02231)	E-4458C Composite				
18000, 20000	FA232 (02231), FA233 (02233)	E-4458B Bronze	1.999" x 11.212"	B	474520C91	Meritor axle FL931.
		E-4458C Composite			597258C91	
		E-4458C Composite				
24000	FA242 (02242)	E-4451B Bronze	1.609" x 9.660"	B	399942C93	Dual 12,000 lb. Navistar axles.
		E-6875C Composite			1658934C93	
32000	FA241 (02241)	E-4458B Bronze	1.999" x 11.212"	B	474520C91	Dual Meritor 16,000 lb. FL931 axles.
		E-4458C Composite			597258C91	
		E-4458C Composite				
	FL941 (02241)	E-4458C Composite				

Tie Rod Ends

Axle Rating Lbs.	Axle Code/Year	Part Number/ Location	Stud Center to Rod End	OEM Reference	Notes
16000, 18000, 20000, 32000	FL941	E-4629 Curbside	7.37"	486355C91	Meritor axle codes 02231, 02232, 02233, 02241.
		E-4628 Roadside		486354C91	
21000	FDS1805 (02195)	E-4642 Curbside	5.75"	491666C91	After 2/2/83. 1.25"-16 RH thread.
		E-6858 Roadside		592872C91	After 2/2/83. 1.25"-18 RH thread.
		E-4619 Roadside		491665C91	Before 2/2/83. 1.25"-12 RH thread.
24000	I120 (02242)	E-4631 Curbside	9.188"	1649638C91	Spicer axle code 02242.
		E-4630 Roadside		1649637C91	



an **ArvinMeritor™** brand

NAVISTAR

Cargostar Models CO1610, CO1630, CO1710, CO1730, CO1750, CO1810, COF1810, CO1830, CO1850, CO1910, COF1910, CO1950, COF1950

King Pin Kits

Axle Rating Lbs.	Axle Code/Year	Part Number/ Bushing Type	King Pin Size	Type	OEM Reference	Notes
6000	FA74 (02074)	E-4460B Bronze	1.359" x 7.968"	A	473695C91	
7000	FA99 (02099)	E-4431B Bronze	1.234" x 7.656"	A	61556R91	
7500	FA103 (02103)	E-4460B Bronze	1.359" x 7.968"	A	473695C91	
	FA99 (02099)	E-4431B Bronze	1.234" x 7.656"		61556R91	
9000	FA109 (02109)	E-4448B Bronze	1.480" x 8.866"	B	408547C93	
		E-4461B Bronze	1.484" x 8.866"	A	493092C91	
	FA209 (02209)	E-4441B Bronze	1.434" x 8.500"	B	303136C92	
	FA309 (02309)	E-4463B Bronze	1.609" x 9.160"	A	493095C91	
		E-4697B Bronze		B	586809C91	
10800	FA329 (02329)	E-4451B Bronze	1.609" x 9.660"	B	399942C93	
		E-4462B Bronze		A	493094C92	
12000	FA139 (02139)	E-4462B Bronze	1.609" x 9.660"	A	493094C92	
	FA219 (02219)	E-4442B Bronze	1.794" x 9.120"	B	303139C92	
	FA339 (02339)	E-4451B Bronze	1.609" x 9.660"		399942C93	
		E-4462B Bronze		A	493094C92	
16000	FA136 (02136)	E-4454B Bronze	1.999" x 11.040"	B	303140C92	Meritor axle FH901.
		E-4454N Nylon				
	FA231 (02231)	E-4458B Bronze	1.999" x 11.212"		474520C91	Meritor axle FL931.
		E-4458C Composite			597258C91	
18000	FA232 (02232)	E-4458B Bronze	1.999" x 11.212"	B	474520C91	Meritor axle FL931.
		E-4458C Composite				597258C91

Tie Rod Ends

Axle Rating Lbs.	Axle Code/Year	Part Number/ Location	Stud Center to Rod End	OEM Reference	Notes
6000	FA69 (02069)	E-4601 Curbside	3.875"	263499C91	
		E-4600 Roadside		263498C91	
	FA74 (02074)	E-4605 Curbside	4.438"	450062C91	
		E-4604 Roadside		450063C91	
7000	FA99 (02099)	E-4601 Curbside	3.875"	263499C91	
		E-4600 Roadside		263498C91	
7500	FA103 (02103)	E-4605 Curbside	4.438"	450062C91	
		E-4604 Roadside		450063C91	
	FA99 (02099)	E-4601 Curbside	3.875"	263499C91	
		E-4600 Roadside		263498C91	
9000	FA109 (02109), FA309 (02309)	E-4615 Curbside	5.44"	507838C91	
		E-4614 Roadside		507837C91	
	FA209 (02209)	E-4611 Curbside	4.875"	110363R92	
		E-4610 Roadside		110362R92	
10800	FA329	E-4615 Curbside	5.44"	507838C91	
		E-4614 Roadside		507837C91	
12000	FA139 (02139), FA339 (02139)	E-4615 Curbside	5.44"	507838C91	
		E-4614 Roadside		507837C91	
	FA219 (02219)	E-4611 Curbside	4.875"	110363R92	
		E-4610 Roadside		110362R92	
16000	FA136 (02136)	E-4617 Curbside	5.75"	969056R91	Meritor axle FH901.
		E-4616 Roadside		969055R91	
	FA231 (02231)	E-4629 Curbside	7.37"	486355C91	Meritor axle FL931.
		E-4628 Roadside		486354C91	
18000	FA232 (02232)	E-4629 Curbside	7.37"	486355C91	Meritor axle FL931.
		E-4628 Roadside		486354C91	

D400, DC400, DCF400, DCF400M, DF400, D405, DC405, DCF405, DCT405, DF405, DT405

King Pin Kits

Axle Rating Lbs.	Axle Code/Year	Part Number/ Bushing Type	King Pin Size	Type	OEM Reference	Notes
11000	FA112 (02112)	E-4449B Bronze	1.607" x 8.740"	B	303138C92	Meritor axle FE970.
12000	FA139 (02139)	E-4451B Bronze	1.609" x 9.660"	B	399942C93	
	FA215 (02215), FA218 (02218)	E-4442B Bronze	1.794" x 9.120"		303139C92	
	FA228 (02228)	E-4450B Bronze	1.794" x 10.410"		452344C91	
16000	FA136 (02136)	E-4454B Bronze	1.999" x 11.040"	B	303140C92	Meritor axle FH901.
		E-4454N Nylon				
18000	FA182 (02182)	E-4454B Bronze	1.999" x 11.040"	B	303140C92	Meritor axle FL901.
		E-4454N Nylon				

Tie Rod Ends

Axle Rating Lbs.	Axle Code/Year	Part Number/ Location	Stud Center to Rod End	OEM Reference	Notes
12000	FA119 (02119)	E-4631 Curbside	9.188"	447095C91	From chassis numbers G297629, Y17500. Greaseable type.
		E-4630 Roadside		447094C91	
	FA139 (02139)	E-4631 Curbside	4.875"	447095C91	Greaseable type.
		E-4630 Roadside		447094C91	
	FA215 (02215), FA218 (02218)	E-4611 Curbside	5.44"	110363R92	
	FA228 (02228)	E-4610 Roadside		110362R92	
16000	FA136 (02136)	E-4615 Curbside	5.75"	438369C91	Meritor axle FF921.
		E-4614 Roadside		438368C91	
		E-4617 Curbside		969056R91	
E-4616 Roadside	969055R91				
18000	FA182 (02182)	E-4617 Curbside	5.75"	969056R91	Meritor axle FL901.
		E-4616 Roadside		969055R91	

S.O.S.

Special Order Service

Can't find it?

Trouble sourcing products?

Need assistance?

Let Euclid's Special Order Service (S.O.S.) help you find your parts.

Euclid's position as the market leader provides you access to a comprehensive array of truck parts products from the industry's leading manufacturers. Through Euclid, these entire product lines are available to you just by placing a phone call to Euclid's S.O.S. Department at 866-238-2543 (option 2) in the U.S. or 800-387-3889 in Canada.

NAVISTAR

Fleetstar Models 1900, F1900, T1900, F1900A, 1910A, 1950, F1950, T1950, 2000, F2000, T2000, 2010A, F2010A, 2050A, F2050A, 2070A, F2070A, 2110A

King Pin Kits

Axle Rating Lbs.	Axle Code/Year	Part Number/ Bushings Type	King Pin Size	Type	OEM Reference	Notes
7000	FA91 (02091), FA98 (02098)	E-4431B Bronze	1.234" x 7.656"	A	61556R91	
7500	FA101(02101)	E-4460B Bronze	1.359" x 7.968"	A	473695C91	
	FA91 (02091), FA98 (02098)	E-4431B Bronze	1.234" x 7.656"		61556R91	
9000	FA105 (02105)	E-4441B Bronze	1.434" x 8.500"	B	363136C92	Meritor axle FD900.
	FA109 (02109)	E-4448B Bronze	1.480" x 8.866"		408547C93	
	FA309 (02309)	E-4461B Bronze	1.484" x 8.866"	A	493092C91	
		E-4463B Bronze	1.609" x 9.160"	B	493095C91	
		E-4451B Bronze	1.609" x 9.660"		399942C93	
	E-6875C Composite			1658934C91		
10800	FA329 (02329)	E-4451B Bronze	1.609" x 9.660"	B	399942C93	Contains lubrication fittings.
		E-4462B Bronze		A	493094C92	
		E-4693B Bronze		B	588808C91	
		E-6875C Composite			1658934C91	
12000	FA112 (02112)	E-4449B Bronze	1.607" x 8.740"	B	303138C92	Meritor axle FE970. Center point steering.
	FA139 (02139)	E-4451B Bronze	1.609" x 9.660"	B	399942C93	Meritor axle FF921.
		E-4462B Bronze	1.609" x 9.660"	A	493094C92	
		E-6875C Composite	1.609" x 9.660"	B	1658934C91	
	FA211 (02211), FA215 (02215)	E-4442B Bronze	1.794" x 9.120"		303139C92	
	FA228 (02228)	E-4450B Bronze	1.794" x 10.410"		452344C91	
	FA339 (02339)	E-4451B Bronze	1.609" x 9.660"		399942C93	
		E-4462B Bronze	1.609" x 9.660"	A	493094C92	
E-6875C Composite		1.609" x 9.660"	B	1658934C91		
16000	FA136 (02136)	E-4454B Bronze	1.999" x 11.040"	B	303140C92	Meritor axle FH901.
		E-4454N Nylon				
	FA231 (02231)	E-4458B Bronze	1.999" x 11.212"		474520C91	
	E-4458C Composite		597258C91			
18000	FA182 (02182)	E-4454B Bronze	1.999" x 11.040"	B	303140C92	Meritor axle FL901.
		E-4454N Nylon				
	FA232 (02232)	E-4458B Bronze	1.999" x 11.212"		474520C91	Meritor axle FL931.
	E-4458C Composite		597258C91			



an **ArvinMeritor**™ brand

Fleetstar Models 1900, F1900, T1900, F1900A, 1910A, 1950, F1950, T1950, 2000, F2000, T2000, 2010A, F2010A, 2050A, F2050A, 2070A, F2070A, 2110A (Continued)

Tie Rod Ends

Axle Rating Lbs.	Axle Code/Year	Part Number/ Location	Stud Center to Rod End	OEM Reference	Notes	
7000	FA91 (02091), FA98 (02098)	E-4601 Curbside	3.875"	263499C91		
		E-4600 Roadside		263498C91		
7500	FA101 (02101)	E-4605 Curbside	4.438"	450062C91		
		E-4604 Roadside		450063C91		
	FA91 (02091), FA98 (02098)	E-4601 Curbside	3.875"	263499C91		
		E-4600 Roadside		263498C91		
9000	FA105 (02105)	E-4611 Curbside	4.875"	110363R92		
		E-4610 Roadside		110362R92		
	FA109 (02109), FA309 (02309)	E-4631 Curbside	9.188"	447095C91		Greaseable type.
		E-4630 Roadside		447094C91		
10800	FA329 (02329)	E-4631 Curbside	9.188"	447095C91	Greaseable type.	
		E-4630 Roadside		447094C91		
12000	FA112 (02112)	E-6848 Curbside	10.50"	894050R93	Meritor axle FE970 with center point steering.	
		E-6847 Roadside		894049R93		
	FA119 (02119), FA139 (02139), FA339 (02339)	E-4631 Curbside	9.188"	447095C91	Greaseable type.	
		E-4630 Roadside		447094C91		
	FA211 (02211), FA215 (02215)	E-4611 Curbside	4.875"	110363R92		
		E-4610 Roadside		110362R92		
	FA228 (02228)	E-4615 Curbside	5.44"	438369C91		Meritor axle FF921.
		E-4614 Roadside		438368C91		
16000	FA136 (02136)	E-4617 Curbside	5.75"	969056R91	Meritor axle FH901.	
		E-4616 Roadside		969055R91		
	FA231 (02231)	E-4629 Curbside	7.37"	486355C91		
		E-4628 Roadside		486354C91		
18000	FA182 (02182)	E-4617 Curbside	5.75"	969056R91	Meritor axle FL901.	
		E-4616 Roadside		969055R91		
	FA232 (02232)	E-4629 Curbside	7.37"	486355C91	Meritor axle FL931.	
		E-4628 Roadside		486354C91		

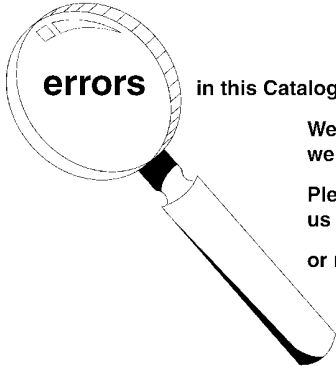

If you detect any **errors** in this Catalog, please let us know.

We want the information to be as accurate as possible; we appreciate your help in making it so.

Please e-mail any comments/suggestions/corrections to us at: catalogfeedback@arvinmeritor.com

or mail to: **Euclid Industries, LLC**
Attn: Catalog Dept.
7975 Dixie Highway
Florence, KY 41042-2754

NAVISTAR

Loadstar and School Bus Models 1600, CO1600, F1600, 1700, CO1700, F1700, 1750, CO1750, 1800, CO1800, F1800, 1850, CO1850, F1850, 1890

King Pin Kits

Axle Rating Lbs.	Axle Code/Year	Part Number/ Bushing Type	King Pin Size	Type	OEM Reference	Notes
5000	FA71 (02071)	E-4460B Bronze	1.359" x 7.968"	A	473695C91	
		E-6198B Bronze	1.359" x 7.970"	B	1660271C92	
5500	FA89 (02089)	E-4431B Bronze	1.234" x 7.656"	A	61556R91	
6000	FA73 (02073)	E-4460B Bronze	1.359" x 7.968"	A	473695C91	
		E-6198B Bronze	1.359" x 7.970"	B	1660271C92	
7000	FA91 (02091), FA98 (02098)	E-4431B Bronze	1.234" x 7.656"	A	61556R91	
7500	FA101 (02101)	E-4460B Bronze	1.359" x 7.968"	A	473695C91	
		E-6198B Bronze	1.359" x 7.970"	B	1660271C92	
9000	FA105 (02105)	E-4441B Bronze	1.434" x 8.500"	B	303136C92	Meritor axle FD900.
	FA109 (02109)	E-4448B Bronze	1.480" x 8.866"		408547C91	
		E-4461B Bronze	1.484" x 8.866"	A	493092C91	
	FA208 (02208)	E-4441B Bronze	1.434" x 8.500"	B	303136C92	
	FA309 (02309)	E-4463B Bronze	1.609" x 9.160"	A	493095C91	
		E-4451B Bronze	1.609" x 9.660"	B	399942C93	
10500, 10800	FA329 (02329)	E-4451B Bronze	1.609" x 9.660"	B	399942C93	
		E-4462B Bronze		A	493094C92	
12000	FA139 (02139), FA339 (02339)	E-4451B Bronze	1.609" x 9.660"	B	399942C93	
		E-4462B Bronze		A	493094C92	
	FA215 (02215), FA218 (02218)	E-4442B Bronze	1.794" x 9.120"	B	303139C92	
	FA228 (02228)	E-4450B Bronze	1.794" x 10.410"		452344C91	
16000	FA136 (02136)	E-4454B Bronze	1.999" x 11.040"	B	303140C92	Meritor axle FF921.
		E-4454N Nylon				

Tie Rod Ends

Axle Rating Lbs.	Axle Code/Year	Part Number/ Location	Stud Center to Rod End	OEM Reference	Notes	
5000	FA68 (02068)	E-4601 Curbside	3.875"	463499C91		
		E-4600 Roadside		263498C91		
	FA71 (02071)	E-4605 Curbside	4.438"	450062C91		
		E-4604 Roadside		450063C91		
5500	FA72 (02072), FA89 (02089)	E-4601 Curbside	3.875"	463499C91		
		E-4600 Roadside		263498C91		
6000	FA73 (02073)	E-4605 Curbside	4.438"	450062C91		
		E-4604 Roadside		450063C91		
7000	FA91 (02091), FA98 (02098)	E-4601 Curbside	3.875"	463499C91		
		E-4600 Roadside		263498C91		
7500	FA101 (02101)	E-4605 Curbside	4.438"	450062C91		
		E-4604 Roadside		450063C91		
	FA91 (02091), FA98 (02098)	E-4601 Curbside	3.875"	463499C91		
		E-4600 Roadside		263498C91		
9000	FA105 (02105)	E-4611 Curbside	4.875"	110363R92	Meritor axle FD900.	
		E-4610 Roadside		110362R92		
	FA109 (02109), FA309 (02309)	E-4631 Curbside	9.188"	447095C91		Greaseable type.
		E-4630 Roadside		447094C91		
	FA208 (02208)	E-4611 Curbside	4.875"	110363R92		
		E-4610 Roadside		110362R92		
10500, 10800	FA329 (02329)	E-4631 Curbside	9.188"	447095C91	Greaseable type.	
		E-4630 Roadside		447094C91		

Loadstar and School Bus Models 1600, CO1600, F1600, 1700, CO1700, F1700, 1750, CO1750, 1800, CO1800, F1800, 1850, CO1850, F1850, 1890 (Continued)

Tie Rod Ends (Continued)

Axle Rating Lbs.	Axle Code/Year	Part Number/ Location	Stud Center to Rod End	OEM Reference	Notes
12000	FA139 (02139), FA339 (02339)	E-4631 Curbside	9.188"	447095C91	Greaseable type.
		E-4630 Roadside		447094C91	
	FA215 (02215), FA218 (02218)	E-4611 Curbside	4.875"	110363R92	
		E-4610 Roadside		110362R92	
	FA228 (02228)	E-4615 Curbside	5.44"	438369C91	Meritor axle FF921.
E-4614 Roadside		438368C91			
16000	FA136 (02136)	E-4617 Curbside	5.75"	969056R91	Meritor axle FH901.
		E-4616 Roadside		969055R91	

M1400, 1452, 1652, M1600

King Pin Kits

Axle Rating Lbs.	Axle Code/Year	Part Number/ Bushing Type	King Pin Size	Type	OEM Reference	Notes
6000	I60 (02ADA)	E-6198B Bronze	1.359" x 7.970"	B	1660271C92	
8000	I80 (02ADB)	E-6198B Bronze	1.359" x 7.970"	B	1660271C92	
16000	FA231 (02231)	E-4458B Bronze	1.999" x 11.212"	B	474520C91	
		E-4458C Composite			597258C91	

Tie Rod Ends

Axle Rating Lbs.	Axle Code/Year	Part Number/ Location	Stud Center to Rod End	OEM Reference	Notes
10000	I100S (02ADC)	E-4615 Curbside	5.44"	507838C91	w/126"-225" WB.
		E-4614 Roadside		507837C91	
		E-4631 Curbside	9.188"	1649638C91	w/226"-280" WB.
		E-4630 Roadside		1649637C91	
12000	I120S (02ADD)	E-4615 Curbside	5.44"	507838C91	w/126"-225" WB.
		E-4614 Roadside		507837C91	
		E-4631 Curbside	9.188"	1649638C91	w/226"-280" WB.
		E-4630 Roadside		1649637C91	
	SDA12 (02083)	E-4611 Curbside	4.875"	110363R92	
		E-4610 Roadside		110362R92	
16000	FA231 (02231)	E-4629 Curbside	7.37"	590583C91	
		E-4628 Roadside		590584C91	

Drag Links

Axle Rating Lbs.	Axle Code/Year	Part Number	Stud Center to Stud Center	OEM Reference	Notes
6000	I60 (02ADA)	E-11463	17.47"	F1215	
8000	I80 (02ADB)	E-11463	17.47"	F1215	
16000	FA231 (02231)	E-11463	17.47"	1661867C91	



an **ArvinMeritor**™ brand

NAVISTAR

Paystar Models 5010, F5010, 5050, F5050, F5050SF, F5050SF-LW, 5070, F5070, F5070SF, F5070SF-LW, CO5370, COF5370

King Pin Kits

Axle Rating Lbs.	Axle Code/Year	Part Number/ Bushing Type	King Pin Size	Type	OEM Reference	Notes		
12000	FA139 (02139)	E-4451B Bronze	1.609" x 9.660"	B	399942C93	Before 1981.		
	FA339 (02339)	E-4451B Bronze						
		E-4462B Bronze		A	493094C92			
		E-4693B Bronze		B	588808C91	From 1981.		
		E-6875C Composite						
16000	FA136 (02136)	E-4454B Bronze	1.999" x 11.040"	B	303140C92	Meritor axle FH901.		
		E-4454N Nylon						
	FA231 (02231)	E-4458B Bronze	1.999" x 11.212"				474520C91	Meritor axle FH901 before 1981. Meritor axle FL931 from 1981. Meritor axle FL941 from Feb. 1981.
		E-4458C Composite					597258C91	
16000, 18000, 20000	I160S (02ADH), I180S (02ADJ), I200S (02ADK)	E-11785B Bronze	2.046" x 11.00"	B	1685405C91			
18000	FA182 (02182)	E-4454B Bronze	1.999" x 11.040"	B	303140C92	Meritor axle FL901.		
		E-4454N Nylon						
	FA232 (02232), FA238 (02238)	E-4458B Bronze	1.999" x 11.212"				474520C91	Meritor axle FL931. Meritor axle FL941 from Feb. 1981.
		E-4458C Composite					597258C91	
20000	FA183 (02183)	E-4454B Bronze	1.999" x 11.040"	B	303140C92	Meritor axle FL901.		
		E-4454N Nylon						
	FA233 (02233), FA239 (02239)	E-4458B Bronze	1.999" x 11.212"				474520C91	Meritor axle FL931. Meritor axle FL941 from Feb. 1981.
		E-4458C Composite					597258C91	

Tie Rod Ends

Axle Rating Lbs.	Axle Code/Year	Part Number/ Location	Stud Center to Rod End	OEM Reference	Notes
12000	FA136 (02136)	E-4617 Curbside	5.75"	969056R91	Meritor axle FH901.
		E-4616 Roadside		969055R91	
	FA136 (02139), FA339 (02339), I120 (02339)	E-4631 Curbside	9.188"	507836C91	Greaseable type.
		E-4630 Roadside		507835C91	
		E-4631 Curbside		1649638C91	
	E-4630 Roadside		1649637C91		
16000	FA136 (02136)	E-4617 Curbside	5.75"	969056R91	Meritor axle FH901.
		E-4616 Roadside		969055R91	
	FA231 (02231)	E-4629 Curbside	7.37"	486355C91	Meritor axle FH901 before 1981. Meritor axle FL931 from 1981.
		E-4628 Roadside		486354C91	
18000	FA182 (02182)	E-4617 Curbside	5.75"	969056R91	Meritor axle FL901.
		E-4616 Roadside		969055R91	
	FA194 (02194)	E-4619 Roadside		491665C91	Meritor axle FDS1807 to 7/27/82. 1.25"-12 RH thread.
		E-6858 Roadside		592872C91	Meritor axle FDS1807 to 7/27/82. 1.25"-18 RH thread.
		E-4642 Curbside		491666C91	Meritor axle FDS1807. 1.25"-16 RH thread.
	FA232 (02232), FA238 (02238)	E-4629 Curbside	7.37"	486355C91	Meritor axle FL931.
		E-4628 Roadside		486354C91	
E-9879 Curbside		590583C91		Meritor axle FL941 from Feb. 1981.	
E-9880 Roadside	590584C91				

Paystar Models 5010, F5010, 5050, F5050, F5050SF, F5050SF-LW, 5070, F5070, F5070SF, F5070SF-LW, CO5370, COF5370 (Continued)

Tie Rod Ends (Continued)

Axle Rating Lbs.	Axle Code/Year	Part Number/ Location	Stud Center to Rod End	OEM Reference	Notes
21000	FA196 (02196) (02ERA)	E-4619 Roadside	5.75"	491665C91	Meritor axle FDS1807 to 7/27/82. 1.25"-12 RH thread.
		E-6858 Roadside		592872C91	Meritor axle FDS1807 to 7/27/82. 1.25"-18 RH thread.
		E-4642 Curbside		491666C91	Meritor axle FDS1807. 1.25"-16 RH thread.

S-Series Heavy Duty Models 2275, F2275, 2276, F2276, 2375, F2375, 2524, F2524, 2554, F2554, 2574, F2574, 2575, F2575, 2624, F2624, 2654, F2654, 2674, F2674, 2675, F2675

King Pin Kits

Axle Rating Lbs.	Axle Code/Year	Part Number/ Bushing Type	King Pin Size	Type	OEM Reference	Notes
7000	FA97 (02097)	E-4431B Bronze	1.234" x 7.656"	A	61556R91	
9000	FA309 (02309)	E-4463B Bronze	1.609" x 9.160"	A	493095C91	
		E-4697B Bronze	1.609" x 9.160"	B	586809C91	Before August 1981.
		E-4693B Bronze	1.609" x 9.660"	B	588808C91	From August 1981. Contains lubrication fittings.
	I90 (02309)	E-4697B Bronze	1.609" x 9.160"	B	586809C91	From February 1981.
10800	FA329 (02329)	E-4451B Bronze	1.609" x 9.660"	B	399942C93	Before August 1981.
		E-4693B Bronze			588808C91	From August 1981. Contains lubrication fittings.
	FA341 (02341)	E-4462B Bronze	A	493094C92	From August 1981.	
	I108 (02329)	E-4693B Bronze	B	588808C91	Contains lubrication fittings.	
		E-6875C Composite			1658934C92	
12000	EFA12 (02250)	E-4696B Bronze	1.625" x 9.195"	A	ETN0806355	
		E-4696C Composite				
	FA226 (02226)	E-4468B Bronze	1.794" x 10.392"	B	549800C91	Meritor axles FF931, FF941.
		E-4694C Composite			597556C91	
		E-6199B Bronze				
		E-6199C Composite			1665531C91	Meritor axles FF931, FF941.
	FA336 (02336), FA337 (02337)	E-4693B Bronze	1.609" x 9.660"	B	588808C91	Contains lubrication fittings.
		E-6875C Composite			1658934C92	
	FA338 (02338)	E-4693B Bronze			588808C91	Contains lubrication fittings.
	FA339 (02339)	E-4451B Bronze			399942C93	Before August 1981.
E-4693B Bronze				588808C91	From August 1981. Contains lubrication fittings.	
FA340 (02340)	E-4462B Bronze	1.609" x 9.660"	A	493094C92		
	E-6875C Composite	1.609" x 9.660"	B	1658934C92		
	E-6199B Bronze	1.794" x 10.392"				
FF961 (02ARA)	E-6199C Composite			1665531C91		
13200	FF942 (02227)	E-4694C Composite	1.794" x 10.392"	B	597556C91	Meritor axle FF942NX31.
		E-6199B Bronze				
		E-6199C Composite			1665531C91	Meritor axle FF942NX609.
16000	FA231 (02231)	E-4458B Bronze	1.999" x 11.212"	B	474520C91	FH901, FL931 from August 1981.
		E-4458C Composite			597258C91	Meritor axle FL941.
16000, 18000, 20000	I160S (02ADH)	E-11785B Bronze	2.046" x 11.00"	B	1685405C91	
18000	FA232 (02232)	E-4458B Bronze	1.999" x 11.212"	B	474520C91	Meritor axles FL931, FL941.
		E-4458C Composite			597258C91	
20000	FA233 (02233)	E-4458B Bronze	1.999" x 11.212"	B	474520C91	Meritor axles FL931, FL941.
		E-4458C Composite			597258C91	

NAVISTAR

S-Series Heavy Duty Models 2275, F2275, 2276, F2276, 2375, F2375, 2524, F2524, 2554, F2554, 2574, F2574, 2575, F2575, 2624, F2624, 2654, F2654, 2674, F2674, 2675, F2675 (Continued)

King Pin Kits (Continued)

Axle Rating Lbs.	Axle Code/Year	Part Number/ Bushing Type	King Pin Size	Type	OEM Reference	Notes
24000	FA248 (02248)	E-4462B Bronze	1.609" x 9.660"	A	493094C92	To February 1981.
		E-6875C Composite		B	1658934C92	From February 1981.

Tie Rod Ends

Axle Rating Lbs.	Axle Code/Year	Part Number/ Location	Stud Center to Rod End	OEM Reference	Notes
7000	FA97 (02097)	E-4601 Curbside	3.875"	263499C91	
		E-4600 Roadside		263498C91	
9000	FA309 (02309)	E-4631 Curbside	9.188"	507836C91	Greaseable type.
		E-4630 Roadside		507835C91	
	190 (02309)	E-4631 Curbside		1649638C91	
		E-4630 Roadside		1649637C91	
10800	FA329 (02329), FA341 (02341)	E-4631 Curbside	9.188"	507836C91	
		E-4630 Roadside		507835C91	
	1108 (02329)	E-4631 Curbside		1649638C91	
		E-4630 Roadside		1649637C91	
12000	E12001 (02AED)	E-10137 Curbside	6.00"	817019	
		E-10138 Roadside		817018	
	EFA12 (02250)	E-4615 Curbside	5.44"	507838C91	
		E-4614 Roadside		507837C91	
	FA226 (02226)	E-4615 Curbside	5.44"	507838C91	Meritor axle FF931.
		E-4614 Roadside		507837C91	
	FA336 (02336)	E-5470 Curbside	5.44"	506662C91	For dropped I-beam.
		E-5469 Roadside		506661C91	
	FA337 (02337)	E-4631 Curbside	9.188"	1649638C91	For straight I-beam.
		E-4630 Roadside		1649637C91	
	FA338 (02338)	E-5470 Curbside	5.44"	506662C91	Drop-end type.
		E-5469 Roadside		506661C91	
	FA339 (02339), FA340 (23040)	E-4631 Curbside	9.188"	507836C91	Greaseable type.
		E-4630 Roadside		507835C91	
16000	FA231 (02231)	E-4629 Curbside	7.37"	486355C91	Meritor axle FH901 to August 1981.
		E-4628 Roadside		486354C91	Meritor axle FL931 from August 1981.
		E-9879 Curbside		590583C91	Meritor axle FL941.
		E-9880 Roadside		590584C91	
18000	FA232 (02232)	E-4629 Curbside	7.37"	486355C91	Meritor axle FL931.
		E-4628 Roadside		486354C91	
		E-9879 Curbside		590583C91	Meritor axle FL941.
		E-9880 Roadside		590584C91	
20000	FA233 (02233)	E-4629 Curbside	7.37"	486355C91	Meritor axle FL931.
		E-4628 Roadside		486354C91	
		E-9879 Curbside		590583C91	Meritor axle FL941.
		E-9880 Roadside		590584C91	
24000	FA248 (02248)	E-4631 Curbside	9.188"	1649638C91	
		E-4630 Roadside		1649637C91	

**S-Series Heavy Duty Models 2275, F2275, 2276, F2276, 2375, F2375, 2524, F2524, 2554, F2554, 2574, F2574, 2575, F2575, 2624, F2624, 2654, F2654, 2674, F2674, 2675, F2675
(Continued)**

Drag Links

Axle Rating Lbs.	Axle Code/Year	Part Number	Stud Center to Stud Center	OEM Reference	Notes
		E-6849	5.50" Stud center to rod end	486807C91	End only. Use with E-6804, E-6878.
		E-5390	16.84"	489023C91	For steering code 05057.1600.
		E-6804	17.13"	493652C91	For steering codes 05344, exc. models F2624, F2654, F2674. Includes end 486807C91 (E-6849).
		E-6878	17.37"	490425C91	For steering codes 05337, 05338, exc. models 2624, F2624, 2654, F2654, 2674, F2674. Includes end 486407C91 (E-6849).
		E-5366	18.14"	480645C92	For steering codes 05057, 05058, 05171, 05318, 05319, 05332, 05333, 05334, 05335, 05336, 05339, 05342, exc. models F2624, F2625, F2654, F2674.

S-Series Heavy Duty Models 2554, 2574, 2654, 2674 (Built 1989 and Later)

King Pin Kits

Axle Rating Lbs.	Axle Code/Year	Part Number/ Bushings Type	King Pin Size	Type	OEM Reference	Notes
12000	FF961 (02ARA)	E-6199C Composite	1.794" x 10.392"	B	1665531C91	
13200	FA227 (02227)	E-4468B Bronze	1.794" x 10.392"	B	549800C91	
		E-4694C Composite			597556C91	
	E-6199C Composite	1665531C91				
	E-4694C Composite	597556C91				
	FF942 (02227)	E-6199C Composite			1665531C91	
16000, 18000, 20000	FA231 (02231), FA232 (02232), FA233 (02233), FL941 (02231)	E-4458B Bronze	1.999" x 11.212"	B	474520C91	
		E-4458C Composite			597258C91	

Tie Rod Ends

Axle Rating Lbs.	Axle Code/Year	Part Number/ Location	Stud Center to Rod End	OEM Reference	Notes
10000	I100S (02ADC)	E-4615 Curbside	5.44"	507838C91	w/126"-225" WB.
		E-4614 Roadside		507837C91	
		E-4631 Curbside	9.188"	1649638C91	w/226"-280" WB.
		E-4630 Roadside		1649637C91	
12000	I120S (02ADD)	E-4631 Curbside	9.188"	1649638C91	w/226"-280" WB.
		E-4630 Roadside		1649637C91	
	I120S (02ADD), FF961 (02ARA)	E-4615 Curbside	5.44"	507838C91	w/126"-225" WB.
		E-4614 Roadside		507837C91	
	I120S (02ADG)	E-9952 Curbside	9.438"	1668410C91	
		E-9951 Roadside		1668409C91	
13200	FA227, FF942 (02227)	E-4615 Curbside	5.44"	507838C91	
		E-4614 Roadside		507837C91	
14000	I140S (02ADE)	E-4615 Curbside	5.44"	1668408C91	
		E-4614 Roadside		1668407C91	
16000, 18000, 20000	FA231 (02231), FA232 (02232), FA233 (02233), FL941 (02231)	E-9879 Curbside	7.37"	590583C91	
		E-9880 Roadside		590584C91	

NAVISTAR

S-Series Heavy Duty Models 2554, 2574, 2654, 2674 (Built 1989 and Later) (Continued)

Drag Links

Axle Rating Lbs.	Axle Code/Year	Part Number	Stud Center to Stud Center	OEM Reference	Notes
		E-9911	17.68"	1661437C92	Used on 05PTA, 05PRH (2500).
		E-5366	18.14"	480645C92	Used on 05PTB 2004 LH P/S.

S-Series Medium Duty Models 1624, 1654, 1658, 1723, 1724, 1753, 1754, 1758, 1823, 1824, 1853, 1854, 1858, 1924, F1924, 1925, 1954, F1954, 1955, 1958, 2125, F2125, 2155

King Pin Kits

Axle Rating Lbs.	Axle Code/Year	Part Number/ Bushings Type	King Pin Size	Type	OEM Reference	Notes	
5000	FA71, I50 (02071)	E-4460B Bronze	1.359" x 7.968"	A	473695C91		
		E-6198B Bronze	1.359" x 7.970"	B	1660271C92		
6000	FA73, I60 (02073)	E-4460B Bronze	1.359" x 7.968"	A	473695C91		
		E-6198B Bronze	1.359" x 7.970"	B	1660271C92		
7500	FA101, I75 (02101)	E-4460B Bronze	1.359" x 7.968"	A	473695C91		
		E-6198B Bronze	1.359" x 7.970"	B	1660271C92		
8000	FA104, I80 (02104)	E-4460B Bronze	1.359" x 7.968"	A	473695C91		
		E-6198B Bronze	1.359" x 7.970"	B	1660271C92		
9000	FA109 (02109)	E-4448B Bronze	1.480" x 8.866"	B	408547C93		
		E-4461B Bronze	1.484" x 8.866"	A	493092C91		
		E-4451B Bronze	1.609" x 9.660"	B	399942C93	Before 1981.	
	FA118 (02118)	E-4462B Bronze		A	493094C92		
		E-4693B Bronze		B	588808C91	From 1981. Contains lubrication fittings.	
		E-6875C Composite			1658934C92		
	FA309, FA242 (02309)	E-4463B Bronze	1.609" x 9.160"	A	493095C91		
		E-4697B Bronze		B	586809C91		
	I90 (02309)	E-4697B Bronze					
		E-6875C Composite	1.609" x 9.660"			1658934C92	
10800	FA127 (02127)	E-4451B Bronze	1.609" x 9.660"	B	399942C93	Before 1981.	
		E-4462B Bronze		A	493094C92		
		E-4693B Bronze		B	588808C91	From 1981. Contains lubrication fittings.	
		E-6875C Composite			1658934C92		
	FA329, FA337 (02329)	E-4451B Bronze			399942C93		
		E-6875C Composite			1658934C92		
	I108 (02329)	E-4693B Bronze			588808C91		
		E-6875C Composite			1658934C92		
	12000	FA139 (02139)	E-4451B Bronze	1.609" x 9.660"	B	399942C93	Before 1981.
			E-4462B Bronze		A	493094C92	
E-4693B Bronze				B	588808C91	From 1981. Contains lubrication fittings.	
E-6875C Composite					1658934C92		
FA223 (02223)		E-4468B Bronze	1.794" x 10.392"		549800C91		
		E-4694C Composite			597556C91		
		E-6199C Composite			1665531C91		
FA226 (02226)		E-4468B Bronze			549800C91	Meritor axle FF941.	
		E-4694C Composite			597556C91		
		E-6199C Composite			1665531C91		
FA227 (02227)		E-4468B Bronze			549800C91	Meritor axle FF942.	
		E-4694C Composite			597556C91		
		E-6199C Composite			1665531C91		
FA339 (02339)		E-4451B Bronze	1.609" x 9.660"		399942C93		
		E-6875C Composite			1658934C92		
I120 (02339)		E-4693B Bronze			588808C91		
		E-6875C Composite			1658934C92		

**S-Series Medium Duty Models 1624, 1654, 1658, 1723, 1724, 1753, 1754, 1758, 1823, 1824, 1853, 1854, 1858, 1924, F1924, 1925, 1954, F1954, 1955, 1958, 2125, F2125, 2155
(Continued)**

King Pin Kits (Continued)

Axle Rating Lbs.	Axle Code/Year	Part Number/ Bushings Type	King Pin Size	Type	OEM Reference	Notes
13200	FA227 (02227)	E-4468B Bronze	1.794" x 10.392"	B	549800C91	Meritor axles FF931, FF942.
		E-4694C Composite			597556C91	
		E-6199C Composite			1665531C91	
14000	FA342 (02342)	E-4451B Bronze	1.609" x 9.660"	B	399942C93	Before 1981.
		E-4693B Bronze			588808C91	From 1981. Contains lubrication fittings.
		E-6875C Composite			1658934C92	
16000	FA231 (02231)	E-4458B Bronze	1.999" x 11.212"	B	474520C91	Meritor axle FL941.
		E-4458C Composite			597258C91	
18000	FA232 (02232)	E-4458B Bronze	1.999" x 11.212"	B	474520C91	Meritor axle FL941.
		E-4458C Composite			597258C91	
20000	FA233 (02233)	E-4458B Bronze	1.999" x 11.212"	B	474520C91	Meritor axle FL941.
		E-4458C Composite			597258C91	

Tie Rod Ends

Axle Rating Lbs.	Axle Code/Year	Part Number/ Location	Stud Center to Rod End	OEM Reference	Notes	
5000	FA71, I50 (02071)	E-4605 Curbside	4.438"	450062C91		
		E-4604 Roadside		450063C91		
6000	FA73, I60 (02073)	E-4605 Curbside	4.438"	450062C91		
		E-4604 Roadside		450063C91		
7500	FA101, I75 (02101)	E-4605 Curbside	4.438"	450062C91		
		E-4604 Roadside		450063C91		
8000	FA104, I80 (02104)	E-4605 Curbside	4.438"	450062C91		
		E-4604 Roadside		450063C91		
9000	FA109 (02109)	E-4615 Curbside	5.44"	507838C91	From February 1981, greaseable type.	
		E-4614 Roadside		507837C91		
		E-4631 Curbside	9.188"	507836C91		Greaseable type.
		E-4630 Roadside		507835C91		
	FA118 (02118), FA309 (02309) I90 (02309)	E-4631 Curbside	5.44"	507836C91	Drop-end type.	
		E-4630 Roadside		507835C91		
		E-5470 Curbside	9.188"	506662C91		For straight I-beam.
		E-5469 Roadside		506661C91		
E-4631 Curbside	10.84"	1649638C91	For dropped I-beam.			
E-4630 Roadside		1649637C91				
10800	FA127 (02127)	E-4631 Curbside	9.188"	507836C91	Greaseable type.	
		E-4630 Roadside		507835C91		
	FA329 (02329)	E-4631 Curbside	9.188"	507836C91		
		E-4630 Roadside		507835C91		
	FA337 (02329)	E-4631 Curbside	9.188"	1649638C91	For straight I-beam.	
		E-4630 Roadside		1649637C91		
	I108 (02329)	E-5470 Curbside	5.44"	506662C91	Drop-end type.	
		E-5469 Roadside		506661C91		
		E-4631 Curbside	9.188"	1649638C91	For straight I-beam.	
		E-4630 Roadside		1649637C91		
		E-6136 Curbside	10.84"	1658947C91	For dropped I-beam.	
		E-6135 Roadside		1658946C91		

NAVISTAR

S-Series Medium Duty Models 1624, 1654, 1658, 1723, 1724, 1753, 1754, 1758, 1823, 1824, 1853, 1854, 1858, 1924, F1924, 1925, 1954, F1954, 1955, 1958, 2125, F2125, 2155

(Continued)

Tie Rod Ends (Continued)

Axle Rating Lbs.	Axle Code/Year	Part Number/ Location	Stud Center to Rod End	OEM Reference	Notes
12000	FA139 (02139)	E-4631 Curbside	9.188"	507836C91	Greaseable type.
		E-4630 Roadside		507835C91	
	FA226 (02226)	E-4615 Curbside	5.44"	507838C91	Meritor axle FF941.
		E-4614 Roadside		507837C91	
	FA227 (02227)	E-4615 Curbside		507838C91	
		E-4614 Roadside		507837C91	
	FA228 (02228)	E-4615 Curbside	507838C91		
		E-4614 Roadside	507837C91		
	FA339 (02339)	E-4631 Curbside	9.188"	507836C91	Greaseable type.
		E-4630 Roadside		507835C91	
	I120 (02337) (02339)	E-5470 Curbside	5.44"	506662C91	Drop-end type.
		E-5469 Roadside		506661C91	
		E-4631 Curbside	9.188"	1649638C91	For straight I-beam.
		E-4630 Roadside		1649637C91	
E-6136 Curbside		10.84"		1658947C91	
E-6135 Roadside	1658946C91				
SDA12 (02EYB)	E-4611 Curbside	4.875"	110363R92	Front driving axle (02032, 02083).	
	E-4610 Roadside		110362R92		
13200	FA227 (02227)	E-4615 Curbside	5.44"	507838C91	Meritor axle FF942.
		E-4614 Roadside		507837C91	
	I132 (02342)	E-4631 Curbside	9.188"	1649638C91	For straight I-beam.
		E-4630 Roadside		1649637C91	
13500	I132 (02342)	E-6136 Curbside	10.84"	1658947C91	For dropped I-beam.
		E-6135 Roadside		1658946C91	
14000	FA342 (02342)	E-4631 Curbside	9.188"	507836C91	Greaseable type.
		E-4630 Roadside		507835C91	
16000	FA231 (02231)	E-9879 Curbside	7.37"	590583C91	Meritor axle FL931, FL941.
		E-9880 Roadside		590584C91	
		E-4629 Curbside		486355C91	Meritor axle FL941.
		E-4628 Roadside		486354C91	
18000	FA231 (02231)	E-9879 Curbside	7.37"	590583C91	Meritor axle FL931, FL941.
		E-9880 Roadside		590584C91	
		E-4629 Curbside		486355C91	Meritor axle FL941.
		E-4628 Roadside		486354C91	
20000	FA231 (02231)	E-9879 Curbside	7.37"	590583C91	Meritor axle FL931, FL941.
		E-9880 Roadside		590584C91	
		E-4629 Curbside		486355C91	Meritor axle FL941.
		E-4628 Roadside		486354C91	

If you detect any **errors** in this Catalog, please let us know.

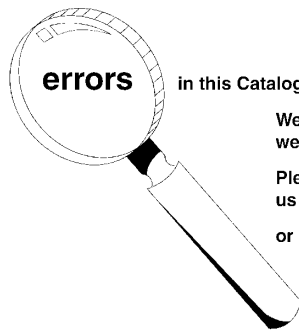

We want the information to be as accurate as possible; we appreciate your help in making it so.

Please e-mail any comments/suggestions/corrections to us at: catalogfeedback@arvinmeritor.com

or mail to: **Euclid Industries, LLC**
Attn: Catalog Dept.
7975 Dixie Highway
Florence, KY 41042-2754

S-Series Medium Duty Models 1624, 1654, 1658, 1723, 1724, 1753, 1754, 1758, 1823, 1824, 1853, 1854, 1858, 1924, F1924, 1925, 1954, F1954, 1955, 1958, 2125, F2125, 2155 (Continued)

Drag Links

Axle Rating Lbs.	Axle Code/Year	Part Number	Stud Center to Stud Center	OEM Reference	Notes
5000	FA71 (02071)	E-5390	16.84"	489023C91	For steering codes 05165, 05345.
	I50 (02071)	E-5390			
6000	FA73 (02073)	E-5390	16.84"	489023C91	For steering codes 05165, 05345.
	I60 (02073)	E-5390			
7500	FA101 (02101)	E-5390	16.84"	489023C91	For steering codes 05057, 05345.
	I75 (02101)	E-5390			
8000	FA104, I80 (02104)	E-5390	16.84"	489023C91	
9000	FA109 (02109), FA118 (02118), FA309 (02309)	E-5366	18.14"	480645C92	For steering codes 05057, 05333, 05342.
	I90 (02309)	E-5366			
10800	FA127 (02127)	E-5366	18.14"	480645C92	For steering codes 05335 without flotation tires.
	FA329 (02329)	E-5366			For steering codes 05058, 05332, 05335 without flotation tires (exc. 1853FC model from 1981).
	I108 (02329)	E-5366			Exc. 1853FC model from 1981.
12000	FA139 (02139)	E-5366	18.14"	480645C92	For steering code 05335 without flotation tires before 1981 or for 2100 model from 1981.
	FA226 (02226)	E-5366			Meritor axles FF941, FF942. For code 05335.0004.
	FA339 (02339)	E-5366			For steering code 05335 without flotation tires (exc. 1853FC model from 1981).
	I120 (02329)	E-5366			For models without flotation tires from 1981 exc. 1853FC model.
14000	FA342 (02342)	E-6804	17.13"	486979C92	For codes 05298, 05337.

Transtar 4070B, CO4070B, F4070B, COF4070B, 4170, F4170

King Pin Kits

Axle Rating Lbs.	Axle Code/Year	Part Number/ Bushings Type	King Pin Size	Type	OEM Reference	Notes
10800	FA329 (02329)	E-4451B Bronze	1.609" x 9.660"	B	399942C93	Steel I-beam axle.
		E-4462B Bronze		A	493094C92	
		E-4462B Bronze				
12000	FA139 (02139)	E-4451B Bronze	1.609" x 9.660"	B	399942C93	Steel I-beam axle.
	FA228 (02228)	E-4450B Bronze	1.794" x 10.410"		452344C91	
	FA339 (02339)	E-4451B Bronze	1.609" x 9.660"		399942C93	
	FA340 (02340)	E-4462B Bronze	1.999" x 11.040"	A	493094C92	
		E-4462B Bronze				
16000	FA136 (02136)	E-4454B Bronze	1.999" x 11.040"	B	303140C92	Meritor axle FH901.
		E-4454N Nylon				
	FA231 (02231)	E-4458B Bronze	1.999" x 11.212"		474520C91	
		E-4458C Composite			597258C91	

NAVISTAR

Transtar 4070B, CO4070B, F4070B, COF4070B, 4170, F4170 (Continued)

Tie Rod Ends

Axle Rating Lbs.	Axle Code/Year	Part Number/ Location	Stud Center to Rod End	OEM Reference	Notes
10800	FA329 (02329), FA341 (02341)	E-4631 Curbside	9.188"	507836C91	Greaseable type.
		E-4630 Roadside		507835C91	
12000	FA139 (02139), FA339 (02339), FA340 (02340)	E-4631 Curbside	9.188"	507836C91	Greaseable type.
		E-4630 Roadside		507835C91	
	FA228 (02228)	E-4615 Curbside	5.44"	438369C91	
		E-4614 Roadside		438368C91	
16000	FA136 (02136)	E-4617 Curbside	5.75"	969056R91	Meritor axle FH901.
		E-4616 Roadside		969055R91	
	FA231 (02231)	E-4629 Curbside	7.37"	486355C91	
		E-4628 Roadside		486354C91	

Drag Links

Axle Rating Lbs.	Axle Code/Year	Part Number	Stud Center to Stud Center	OEM Reference	Notes
10800, 12000, 16000	All	E-6808	17.29"	453831C91	For steering codes 05331, 05293. Includes replaceable end.
16000	All	E-4629	7.37" Stud center to rod end	486355C91	End only. Use with E-6808.

Transtar CO4070A, COF4070A

King Pin Kits

Axle Rating Lbs.	Axle Code/Year	Part Number/ Bushing Type	King Pin Size	Type	OEM Reference	Notes
12000	FA112 (02112)	E-4449B Bronze	1.607" x 8.740"	B	303138C92	Meritor axle FE970. Center point steering.
	FA139 (02139)	E-4451B Bronze			399942C93	
16000	FA136 (02136)	E-4454B Bronze	1.999" x 11.040"	B	303140C92	Meritor axle FH901.
		E-4454N Nylon				
18000	FA182 (02182)	E-4454B Bronze	1.999" x 11.040"	B	303140C92	Meritor axle FL901.
		E-4454N Nylon				

Tie Rod Ends

Axle Rating Lbs.	Axle Code/Year	Part Number/ Location	Stud Center to Rod End	OEM Reference	Notes
12000	FA119 (02119)	E-4631 Curbside	9.188"	377636C91	Greaseable type from 1970.
		E-4630 Roadside		377635C91	
	FA139 (02139)	E-4631 Curbside	9.188"	507836C91	Greaseable type.
		E-4630 Roadside		507835C91	
	FA215 (02215)	E-4611 Curbside	4.875"	110363R92	
		E-4610 Roadside		110362R92	
16000	FA136 (02136)	E-4617 Curbside	5.75"	969056R91	Meritor axle FH901.
		E-4616 Roadside		969055R91	
18000	FA182 (02182)	E-4617 Curbside	5.75"	969056R91	Meritor axle FL901.
		E-4616 Roadside		969055R91	



an **ArvinMeritor**™ brand

Transtar Models 4200, F4200, 4300, F4300

King Pin Kits

Axle Rating Lbs.	Axle Code/Year	Part Number/ Bushing Type	King Pin Size	Type	OEM Reference	Notes
10800	FA329 (02329)	E-4451B Bronze	1.609" x 9.660"	B	399942C93	Steel axle.
		E-4462B Bronze		A	493094C92	
	FA341 (02341)	E-4462B Bronze				
12000	FA112 (02112)	E-4449B Bronze	1.607" x 8.740"	B	303138C92	Meritor axle FE970. Center point steering.
	FA139 (02139), FA339 (02339)	E-4451B Bronze	1.609" x 9.660"		399942C93	
		E-4462B Bronze		A	493094C92	
	FA218 (02218)	E-4442B Bronze	1.794" x 9.120"	B	303139C92	Meritor axle FF941.
	FA223 (02223)	E-4468B Bronze	1.794" x 10.392"		549800C91	
	FA226 (02226)	E-4694C Composite			597556C91	Meritor axle FF931.
		E-4468B Bronze			549800C91	
	FA228 (02228)	E-4694C Composite			597556C91	Meritor axle FF921.
		E-4450B Bronze			452344C91	
	FA234 (02234)	E-4595B Bronze	1.607" x 9.375"		577684C91	Meritor axle FF971. Center point steering.
FA340 (02340)	E-4462B Bronze	1.609" x 9.660"	A	493094C92	Steel axle.	
13200	FA227 (02227)	E-4468B Bronze	1.794" x 10.392"	B	549800C91	Meritor axle FF932.
		E-4694C Composite			597556C91	
16000	FA136 (02136)	E-4454B Bronze	1.999" x 11.040"	B	303140C92	Meritor axle FH901.
		E-4454N Nylon				
	FA231 (02231)	E-4458B Bronze	1.999" x 11.212"		474520C91	Meritor axle FH901 before 1981. Meritor axle FL931 from Aug. 1981.
		E-4458C Composite			597258C91	

Tie Rod Ends

Axle Rating Lbs.	Axle Code/Year	Part Number/ Location	Stud Center to Rod End	OEM Reference	Notes
10800	FA329 (02329), FA341 (02341)	E-4631 Curbside	9.188"	507836C91	Greaseable type.
		E-4630 Roadside		507835C91	
12000	FA112 (02112)	E-6848 Curbside	10.50"	894050R93	Meritor axle FE970.
		E-6847 Roadside		894049R93	
	FA139 (02139), FA339 (02339), FA340 (02340)	E-4631 Curbside	9.188"	507836C91	Greaseable type.
		E-4630 Roadside		507835C91	
	FA218 (02218)	E-4611 Curbside	4.875"	110363R92	
		E-4610 Roadside		11036R92	
	FA223 (02223)	E-4615 Curbside	5.44"	507838C91	Meritor axle FF941.
		E-4614 Roadside		507837C91	
	FA224 (02224)	E-4615 Curbside		507838C91	Meritor axle FF931A.
		E-4614 Roadside		507837C91	
	FA226 (02226)	E-4615 Curbside		507838C91	Meritor axle FF931.
		E-4614 Roadside		507837C91	
	FA228 (02228)	E-4615 Curbside		438369C91	Meritor axle FF921.
		E-4614 Roadside		438368C91	
FA234 (02234)	E-6848 Curbside	10.50"	577683C93	Meritor axle FF971.	
	E-6847 Roadside		577682C91		
13200	FA227 (02227)	E-4615 Curbside	5.44"	507838C91	Meritor axle FF932.
		E-4614 Roadside		507837C91	
16000	FA136 (02136)	E-4617 Curbside	5.75"	969056R91	Meritor axle FH901.
		E-4616 Roadside		969055R91	
	FA231 (02231)	E-4629 Curbside	7.37"	486355C91	Meritor axle FH901 before 1981. Meritor axle FL931 from 1981.
		E-4628 Roadside		486354C91	

NAVISTAR

Transtar Models 4200, F4200, 4300, F4300 (Continued)

Drag Links

Axle Rating Lbs.	Axle Code/Year	Part Number	Stud Center to Stud Center	OEM Reference	Notes
10800, 16000	All	E-4629	7.37" Stud center to rod end	486355C91	End only. Use with E-6808.
		E-6808	17.29"	453831C91	For steering codes 05331, 05293. Includes replaceable end.

FLEET VEHICLE MAINTENANCE COMPONENTS

The Euclid Brand offers "All-Makes" Aftermarket Maintenance Components for these Vehicle Systems:

BRAKE PRODUCTS

- Euclid New Lined Brake Shoes
- Euclid Relined Brake Shoes
- Euclid Friction Materials
- Camshafts
- Air Drum Brake Components & Kits
- Air Disc Pads & Components
- Hydraulic Disc Pads
- Hydraulic Drum & Disc Brake Components
- Automatic & Manual Slack Adjusters
- Brake & Camshaft Repair Kits

WHEEL END PRODUCTS

- Cast Brake Drums
- X-30 Steelite Brake Drums
- Hubs & Spoke Wheels
- Rotors - Hydraulic Disc
- Wheel Attaching Components
- Seals & Bearings

DRIVELINE PRODUCTS

- Universal Joints - US only
- Center Bearings - US only
- Miscellaneous Hardware - US only

AIR SYSTEM PRODUCTS

- Air Dryers & Cartridges
- Air Valves - New & Reman
- Reman Air Compressors
- Air Brake Hose & Fittings

TRAILER PRODUCTS

- Axle Tubes
- "Dressed" Axles

FRONT AXLE PRODUCTS

- King Pin Kits
- Tie Rod & Drag Link Ends
- Drag Links

SUSPENSION PRODUCTS

- Air Springs
- Equalizers, Hangers, Beams
- Bushings & Hardware
- Speciality Polyurethane Components
- Torque Rods
- U-Bolts
- Gabriel® Shock Absorbers

AIR CONDITIONING & HEATING PRODUCTS

- Compressors
- Clutches
- Blower Motors
- Receiver Driers
- Valves, Switches
- Condensor, Evaporator, Heater Cores
- Tools
- Chemicals, Lubricants
- Refrigerants

ELECTRICAL & WATER PUMPS

- Alternators
- Starters
- Electrical Parts & Accessories
- Water Pumps
- Fan Clutches Rebuilt Kits

OTHER PRODUCTS

- Ankra Cargo Restraint Systems

INDEX

Model	Page No.
252, 282, 289, 300, 348, 352, 352H, 353, 359	11-174

Model	Page No.
310, 320, 330, 357, 362, 372, 375, 376, 377, 378, 379, 385, 387	11-174

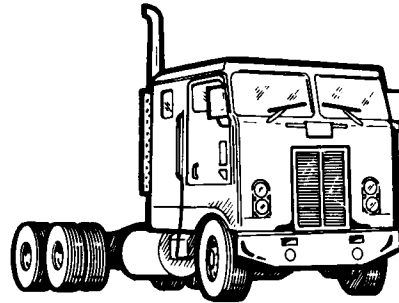

**ALUMINUM TILT CAB
(282, 352, 352-H)**

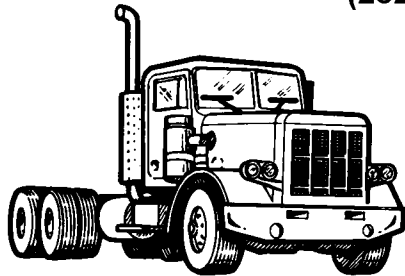

**CONVENTIONAL
(252, 289, 348, 353, 359)**

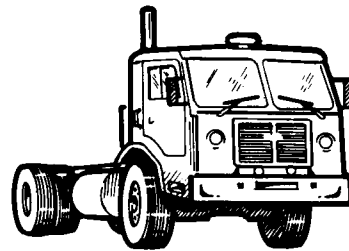

**LOW CAB FORWARD
(300)**

PETERBILT

252, 282, 289, 300, 348, 352, 352H, 353, 359

King Pin Kits

Axle Rating Lbs.	Axle Code/Year	Part Number/ Bushing Type	King Pin Size	Type	OEM Reference	Notes
12000	(FE900)	E-4434B Bronze	9.750"	D	KIT 144	Tapered pin.
		E-4434N Bronze, Nylon			KIT 123	
	(FE970)	E-4449B Bronze	1.607" x 8.740"	B	KIT 157	
	(FF901)	E-4442B Bronze	1.794" x 9.120"		KIT 172	
	(FF921)	E-4450B Bronze	1.794" x 10.410"		KIT 199	
	(FF931)	E-4468B Bronze	1.794" x 10.392"		KIT 195	
		E-4694C Composite			KIT 1307	
	(FF971)	E-4595B Bronze	1.607" x 9.375"		KIT 1300	
16000	(FH901)	E-4454B Bronze	1.999" x 11.040"	B	KIT 170	
		E-4454N Nylon			KIT 168	
	(FL931)	E-4458B Bronze	1.999" x 11.212"		KIT 198	
		E-4458C Composite			KIT 1312	
18000	(FL901)	E-4454B Bronze	1.999" x 11.040"	B	KIT 170	
		E-4454N Nylon			KIT 168	

Tie Rod Ends

Axle Rating Lbs.	Axle Code/Year	Part Number/ Location	Stud Center to Rod End	OEM Reference	Notes	
12000	(FE900)	E-4611 Curbside	4.875"	A3144R226		
		E-4610 Roadside		A3144Q225		
	(FE970)	E-4611 Curbside	10.50"	A3144R226	Will retrofit older axles.	
		E-4610 Roadside		A3144Q225		
		E-6848 Curbside		A3144N534		
	(FF901)	E-6847 Roadside	4.875"	A3144M533		
		E-4611 Curbside		A3144R226		
	(FF901)	E-4610 Roadside	5.75"	A3144Q225	Anti-tilt seal type.	
		E-4618 Curbside		A3144D238		
		E-4619 Roadside		A3144C237		
		E-4617 Curbside		A3144J296		Conventional seal type.
		E-4616 Roadside		A3144K297		
	(FF921)	E-4615 Curbside	5.44"	A3144D524	Greaseable type.	
		E-4614 Roadside		A3144E525		
	(FF931)	E-4615 Curbside	10.50"	A3144D524	Center point steering.	
		E-4614 Roadside		A3144E525		
(FF971)	E-6848 Curbside	10.50"	A3144N534			
	E-6847 Roadside		A3144M533			
16000	(FH901)	E-4617 Curbside	5.75"	A3144J296		
		E-4616 Roadside		A3144K297		
	(FL931)	E-4629 Curbside	7.37"	A3144F448		
		E-4628 Roadside		A3144G449		
18000	(FL901)	E-4617 Curbside	5.75"	A3144J296		
		E-4616 Roadside		A3144K297		

Drag Links

Axle Rating Lbs.	Axle Code/Year	Part Number	Stud Center to Stud Center	OEM Reference	Notes
All	All	E-6818	14.21"	10-02163	L24VU7050B12, DS1179, Rpl/10-2131.
		E-6819	31.69"	10-02260	L24VU7051B12, DS1180, Rpl/10-2132.

Axle Rating Lbs.	Axle Code/Year	Part Number/ Bushing Type	King Pin Size	Type	OEM Reference	Notes	
11000	(FE900)	E-4434B Bronze	9.750"	D	KIT 144	Tapered pin.	
		E-4434N Bronze, Nylon			KIT 123		
12000	(FE970)	E-4449B Bronze	1.607" x 8.740"	B	KIT 157		
	(FF901)	E-4442B Bronze	1.794" x 9.120"		KIT 172		
	(FF921)	E-4450B Bronze	1.794" x 10.410"		KIT 199		
	(FF931)	E-4468B Bronze	1.794" x 10.392"		KIT 195		
		E-4694C Composite			KIT 1307		
	(FF941), (FF942), (FF943), (FF944)	E-4468B Bronze			KIT 195		
		E-4694C Composite			KIT 1307		
		E-6199B Bronze					
		E-6199C Composite			KIT 1315		
	(FF961)	E-6199B Bronze					
	E-6199C Composite	KIT 1315					
	(FF971)	E-4595B Bronze	1.607" x 9.375"		KIT 1300		
	EFA12F4	E-4696B Bronze	1.625" x 9.195"		A		
		E-4696C Composite					806355
13200	EFA12F4	E-4696B Bronze	1.625" x 9.195"	A			
		E-4696C Composite			806355		
14600	(FG941)	E-4695C Composite	1.794" x 10.392"	B	KIT 1309		
		E-6868B Bronze			KIT 1310		
16000	(FH901)	E-4454B Bronze	1.999" x 11.040"	B	KIT 170		
		E-4454N Nylon			KIT 168		
16000, 18000	(FL931)	E-4458B Bronze	1.999" x 11.212"	B	KIT 198		
		E-4458C Composite			KIT 1312		
18000	(FL901)	E-4454B Bronze	1.999" x 11.040"	B	KIT 170		
		E-4454N Nylon			KIT 168		
18000, 20000	(FL941)	E-4458B Bronze	1.999" x 11.212"	B	KIT 198		
		E-4458C Composite			KIT 1312		
18000	EFA18F3	E-6194B Bronze	1.873" x 9.965"	A			
		E-6194C Composite			1008500		
36000	(FL941)	E-4458B Bronze	1.999" x 11.212"	B	KIT 198	Dual steer axle.	
		E-4458C Composite			KIT 1312		

S.O.S.

Special Order Service

Can't find it?

Trouble sourcing products?

Need assistance?

Let Euclid's Special Order Service (**S.O.S.**) help you find your parts.

Euclid's position as the market leader provides you access to a comprehensive array of truck parts products from the industry's leading manufacturers. Through Euclid, these entire product lines are available to you just by placing a phone call to Euclid's S.O.S. Department at 866-238-2543 (option 2) in the U.S. or 800-387-3889 in Canada.

PETERBILT

310, 320, 330, 357, 362, 372, 375, 376, 377, 378, 379, 385, 387 (Continued)

Tie Rod Ends

Axle Rating Lbs.	Axle Code/Year	Part Number/ Location	Stud Center to Rod End	OEM Reference	Notes	
11000	(FE900)	E-4611 Curbside	4.875"	A3144R226		
		E-4610 Roadside		A3144Q225		
		E-4617 Curbside	5.75"	A3144J296		
		E-4616 Roadside		A3144K297		
12000	(FE970)	E-4611 Curbside	4.875"	A3144R226		
		E-4610 Roadside		A3144Q225		
		E-4617 Curbside	5.75"	A3144J296		
		E-4616 Roadside		A3144K297		
		E-6848 Curbside	10.50"	A3144N534		Will retrofit older axles.
		E-6847 Roadside		A3144M533		
	(FF901)	E-4611 Curbside	4.875"	A3144R226		
		E-4610 Roadside		A3144Q225		
		E-4618 Curbside	5.75"	A3144D238		Anti-tilt seal type.
		E-4619 Roadside		A3144C237		
		E-4617 Curbside	5.75"	A3144J296		Conventional seal type.
		E-4616 Roadside		A3144K297		
	(FF921)	E-4615 Curbside	5.44"	A3144D524	Greaseable type.	
		E-4614 Roadside		A3144E525		
	(FF931)	E-4615 Curbside	5.44"	A3144D524		
		E-4614 Roadside		A3144E525		
	(FF941), (FF942), (FF943), (FF944)	E-4615 Curbside	5.44"	A3144D524		
		E-4614 Roadside		A3144E525		
	(FF961)	E-4615 Curbside	5.44"	A3144D524		
		E-4614 Roadside		A3144E525		
	(FF971)	E-6848 Curbside	10.50"	A3144N534	Center point steering.	
		E-6847 Roadside		A3144M533		
E1200I	E-10137 Curbside	6.00"	817019			
	E-10138 Roadside		817018			
12000, 13200	EFA12F4	E-4615 Curbside	5.44"	1006148		
		E-4614 Roadside		1006149		
		E-8758 Curbside	8.125"	1009010		
		E-8757 Roadside		1009009		
14600	(FG941)	E-4615 Curbside	5.44"	A3144D524	Greaseable type.	
		E-4614 Roadside		A3144E525		
16000	(FH901)	E-4617 Curbside	5.75"	A3144J296		
		E-4616 Roadside		A3144K297		
16000, 18000	(FL931)	E-4617 Curbside	5.75"	A3144J296		
		E-4616 Roadside		A3144K297		
		E-4629 Curbside	7.37"	A3144F448		
		E-4628 Roadside		A3144G449		
		E-6856 Curbside	12.688"	A3144V438		
		E-6857 Roadside		A3144U437		
18000	(FL901)	E-4617 Curbside	5.75"	A3144J296		
		E-4616 Roadside		A3144K297		
18000, 20000	(FL941)	E-4617 Curbside	5.75"	A3144J296		
		E-4616 Roadside		A3144K297		
		E-4629 Curbside	7.37"	A3144F448		
		E-4628 Roadside		A3144G449		
		E-6856 Curbside	12.688"	A3144U437		
		E-6857 Roadside		A3144V438		
18000	EFA18F3	E-4629 Curbside	7.37"	820695		
		E-4628 Roadside		820694		

310, 320, 330, 357, 362, 372, 375, 376, 377, 378, 379, 385, 387 (Continued)

Tie Rod Ends (Continued)

Axle Rating Lbs.	Axle Code/Year	Part Number/ Location	Stud Center to Rod End	OEM Reference	Notes
36000	(FL941)	E-4617 Curbside	5.75"	A3144J296	Dual steer axle.
		E-4616 Roadside		A3144K297	
		E-4629 Curbside	7.37"	A3144F448	
		E-4628 Roadside		A3144G449	
		E-6856 Curbside	12.688"	A3144U437	
		E-6857 Roadside		A3144V438	

Drag Links

Axle Rating Lbs.	Axle Code/Year	Part Number	Stud Center to Stud Center	OEM Reference	Notes
All	All	E-6818	14.21"	1002163	L24VU7050B12, DS1179, Rpl/10-2131.
		E-6819	31.69"	1002260	L24VU7051B12, DS1180, Rpl/10-2132.

FLEET VEHICLE MAINTENANCE COMPONENTS

The Euclid Brand offers "All-Makes" Aftermarket Maintenance Components for these Vehicle Systems:

BRAKE PRODUCTS

- Euclid New Lined Brake Shoes
- Euclid Relined Brake Shoes
- Euclid Friction Materials
- Camshafts
- Air Drum Brake Components & Kits
- Air Disc Pads & Components
- Hydraulic Disc Pads
- Hydraulic Drum & Disc Brake Components
- Automatic & Manual Slack Adjusters
- Brake & Camshaft Repair Kits

WHEEL END PRODUCTS

- Cast Brake Drums
- X-30 Steelite Brake Drums
- Hubs & Spoke Wheels
- Rotors - Hydraulic Disc
- Wheel Attaching Components
- Seals & Bearings

DRIVELINE PRODUCTS

- Universal Joints - US only
- Center Bearings - US only
- Miscellaneous Hardware - US only

AIR SYSTEM PRODUCTS

- Air Dryers & Cartridges
- Air Valves - New & Reman
- Reman Air Compressors
- Air Brake Hose & Fittings

TRAILER PRODUCTS

- Axle Tubes
- "Dressed" Axles

FRONT AXLE PRODUCTS

- King Pin Kits
- Tie Rod & Drag Link Ends
- Drag Links

SUSPENSION PRODUCTS

- Air Springs
- Equalizers, Hangers, Beams
- Bushings & Hardware
- Speciality Polyurethane Components
- Torque Rods
- U-Bolts
- Gabriel®** Shock Absorbers

AIR CONDITIONING & HEATING PRODUCTS

- Compressors
- Clutches
- Blower Motors
- Receiver Driers
- Valves, Switches
- Condensor, Evaporator, Heater Cores
- Tools
- Chemicals, Lubricants
- Refrigerants

ELECTRICAL & WATER PUMPS

- Alternators
- Starters
- Electrical Parts & Accessories
- Water Pumps
- Fan Clutches Rebuilt Kits

OTHER PRODUCTS

- Ankra Cargo Restraint Systems

INDEX

Model	Page No.	Model	Page No.
AC Series	11-179	FE42, FE42T, FE64 Series	11-181
ACL Series	11-179	WG Series	11-181
AERO Series	11-180	WHR, WIL, WIA, Series	11-182
Autohailer Tractors	11-181	XPEDITOR	11-183

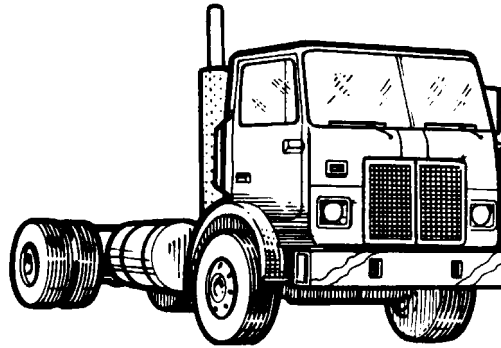

ROAD XPEDITOR 2

VOLVO
AC Series
King Pin Kits

Axle Rating Lbs.	Axle Code/Year	Part Number/ Bushings Type	King Pin Size	Type	OEM Reference	Notes
12000	FF961	E-6199B Bronze	1.794" x 10.392"	B	KIT 1315	
		E-6199C Composite				
14000	VF14	E-10166N Nylon	9.875"	F	3090266	Tapered pin.
16000, 18000, 20000	FL941	E-4458B Bronze	1.999" x 11.212"	B	KIT 198	
		E-4458C Composite			KIT 1312	
18000	VF18	E-10166N Nylon	9.875"	F	3090266	Tapered pin.

Tie Rod Ends

Axle Rating Lbs.	Axle Code/Year	Part Number/ Location	Stud Center to Rod End	OEM Reference	Notes
12000	FF961	E-4615 Curbside	5.44"	37024-0005	
		E-4614 Roadside		37024-0004	
14000	VF14	E-10163 Curbside	4.72"	1698847	
		E-10164 Roadside		1698846	
16000, 18000, 20000	FL941	E-4617 Curbside	5.75"	A3144J296	
		E-4616 Roadside		A3144K297	
		E-4629 Curbside	7.37"	37024-5002	
		E-4628 Roadside		37024-5001	
		E-6856 Curbside	12.688"	A3144D550	
		E-6857 Roadside		A3144C549	
18000	VF18	E-10163 Curbside	4.72"	1698847	
		E-10164 Roadside		1698846	

ACL Series
King Pin Kits

Axle Rating Lbs.	Axle Code/Year	Part Number/ Bushings Type	King Pin Size	Type	OEM Reference	Notes
12000	FF961	E-6199C Composite	1.794" x 10.392"	B	KIT 1315	
	VF12	E-10165N Nylon		F	3130711	
12500	VF12.5	E-10165N Nylon	9.00"	F	3130711	Tapered pin.
14000	VF14	E-10166N Nylon	9.875"	F	3090266	Tapered pin.
14600	FG941	E-4695C Composite	1.794" x 10.392"	B	KIT 1309	
		E-6868B Bronze			KIT 1310	
16000, 18000, 20000	FL941	E-4458B Bronze	1.999" x 11.212"	B	KIT 198	
		E-4458C Composite			KIT 1312	
18000	VF18	E-10166N Nylon	9.875"	F	3090266	All wheel drive. Tapered pin.

If you detect any

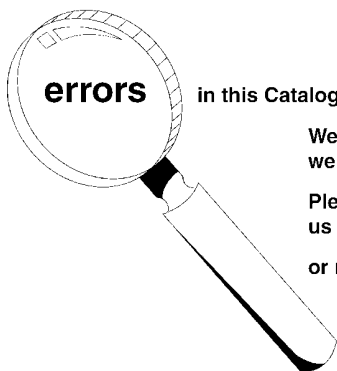

in this Catalog, please let us know.

We want the information to be as accurate as possible;
we appreciate your help in making it so.

Please e-mail any comments/suggestions/corrections to
us at: catalogfeedback@arvinmeritor.com

or mail to:

Euclid Industries, LLC
Attn: Catalog Dept.
7975 Dixie Highway
Florence, KY 41042-2754

VOLVO

ACL Series (Continued)

Tie Rod Ends

Axle Rating Lbs.	Axle Code/Year	Part Number/ Location	Stud Center to Rod End	OEM Reference	Notes
12000, 14600	FF961, FG941	E-4615 Curbside	5.44"	37024-0005	
		E-4614 Roadside		37024-0004	
12000	VF12	E-10163 Curbside	4.72"	1698847	
		E-10164 Roadside		1698846	
12500	VF12.5	E-10163 Curbside	4.72"	1698847	
		E-10164 Roadside		1698846	
14000	VF14	E-10163 Curbside	4.72"	1698847	
		E-10164 Roadside		1698846	
16000, 18000, 20000	FL941	E-4617 Curbside	5.75"	A3144J296	
		E-4616 Roadside		A3144K297	
		E-4629 Curbside	7.37"	37024-5002	
		E-4628 Roadside		37024-5001	
		E-6856 Curbside	12.688"	A3144D550	
E-6857 Roadside	A3144C549				
18000	VF18	E-10163 Curbside	4.72"	1698847	
		E-10164 Roadside		1698846	

AERO Series

King Pin Kits

Axle Rating Lbs.	Axle Code/Year	Part Number/ Bushing Type	King Pin Size	Type	OEM Reference	Notes
12000	EFA-12F4	E-4696B Bronze	1.625" x 9.195"	A		
		E-4696C Composite			806355	
	FF943	E-4468B Bronze	1.794" x 10.392"	B	KIT 195	
		E-4694C Composite			KIT 1307	
	FF961	E-6199B Bronze				
E-6199C Composite		KIT 1315				
14600	FG943	E-10165N Nylon	9.00"	F	3130711	Tapered pin.
		E-4695C Composite	1.794" x 10.392"	B	KIT 1309	
		E-6868B Bronze			KIT 1310	
16500	VF16	E-10166N Nylon	9.875"	F	3090266	Tapered pin.

Tie Rod Ends

Axle Rating Lbs.	Axle Code/Year	Part Number/ Location	Stud Center to Rod End	OEM Reference	Notes
12000	EFA-12F4	E-4615 Curbside	5.44"	1006148/37024-0004	
		E-4614 Roadside		1006149/37024-0005	
		E-8758 Curbside	8.125"	1009010	
		E-8757 Roadside		1009009	
12000, 14600	FF943, FF961, FG943	E-4615 Curbside	5.44"	1006148/37024-0004	
		E-4614 Roadside		1006149/37024-0005	
12000	VF12	E-10163 Curbside	4.72"	1698847	
		E-10164 Roadside		1698846	
16500	VF16	E-10163 Curbside	4.72"	1698847	
		E-10164 Roadside		1698846	



an ArvinMeritor™ brand

Autohauler Tractors

King Pin Kits

Axle Rating Lbs.	Axle Code/Year	Part Number/ Bushings Type	King Pin Size	Type	OEM Reference	Notes
12000	EFA-12F4, E-12001	E-4696B Bronze	1.625" x 9.195"	A	806355	
		E-4696C Composite				
	FF943	E-4468B Bronze	1.794" x 10.392"	B	KIT 195	
		E-4694C Composite			KIT 1307	
	FF961	E-6199B Bronze			KIT 1315	
E-6199C Composite						
14600	FG943	E-4695C Composite	1.794" x 10.392"	B	KIT 1309	
		E-6868B Bronze			KIT 1310	

Tie Rod Ends

Axle Rating Lbs.	Axle Code/Year	Part Number/ Location	Stud Center to Rod End	OEM Reference	Notes
12000	E12001	E-10137 Curbside	6.00"	817019	
		E-10138 Roadside		817018	
	EFA-12F4	E-4615 Curbside	5.44"	1006148	
		E-4614 Roadside		1006149	
		E-8758 Curbside		8.125"	
	E-8757 Roadside		1009009		
12000, 14600	FF943, FF961, FG943	E-4615 Curbside	5.44"	37024-0004	
		E-4614 Roadside		37024-0005	
12000	VF12	E-10163 Curbside	4.72"	1698847	
		E-10164 Roadside		1698846	
12500	VF12.5	E-10163 Curbside	4.72"	1698847	
		E-10164 Roadside		1698846	
14000	VF14	E-10163 Curbside	4.72"	1698847	
		E-10164 Roadside		1698846	

FE42, FE42T, FE64 Series

King Pin Kits

Axle Rating Lbs.	Axle Code/Year	Part Number/ Bushings Type	King Pin Size	Type	OEM Reference	Notes
10000	VF10	E-10165N Nylon	9.00"	F	3130711	Tapered pin.
12000	VF12	E-10165N Nylon	9.00"	F	3130711	Tapered pin.
12500	VF12.5	E-10166N Nylon	9.875"	F	3090266	Tapered pin.
14000	VF14	E-10166N Nylon	9.875"	F	3090266	Tapered pin.
16500	VF16	E-10166N Nylon	9.875"	F	3090266	All wheel drive. Tapered pin.

Tie Rod Ends

Axle Rating Lbs.	Axle Code/Year	Part Number/ Location	Stud Center to Rod End	OEM Reference	Notes
10000	VF10	E-10163 Curbside	4.72"	1698847	
		E-10164 Roadside		1698846	
12000	VF12	E-10163 Curbside	4.72"	1698847	
		E-10164 Roadside		1698846	
12500	VF12.5	E-10163 Curbside	4.72"	1698847	
		E-10164 Roadside		1698846	
14000	VF14	E-10163 Curbside	4.72"	1698847	
		E-10164 Roadside		1698846	
16500	VF16	E-10163 Curbside	4.72"	1698847	
		E-10164 Roadside		1698846	

VOLVO

WG Series

King Pin Kits

Axle Rating Lbs.	Axle Code/Year	Part Number/ Bushings Type	King Pin Size	Type	OEM Reference	Notes
12000	EFA-12F4	E-4696B Bronze	1.625" x 9.195"	A	806355	
		E-4696C Composite				
	FF943	E-4468B Bronze	1.794" x 10.392"	B	KIT 195	
		E-4694C Composite			KIT 1307	
	FF961	E-6199B Bronze			KIT 1315	
E-6199C Composite						
12000, 14600	FG943	E-4695C Composite	1.794" x 10.392"	B	KIT 1309	
		E-6868B Bronze			KIT 1310	
12000	VF12	E-10165N Nylon	9.00"	F	3130711	Tapered pin.
12500	VF12.5	E-10165N Nylon	9.00"	F	3130711	Tapered pin.
14000	VF14	E-10166N Nylon	9.875"	F	3090266	Tapered pin.
16000	VF16	E-10166N Nylon	9.875"	F	3090266	Tapered pin.
18000	VF18	E-10166N Nylon	9.875"	F	3090266	Tapered pin.
20000	FL941	E-4458B Bronze	1.999" x 11.212"	B	KIT 198	
		E-4458C Composite			KIT 1312	

Tie Rod Ends

Axle Rating Lbs.	Axle Code/Year	Part Number/ Location	Stud Center to Rod End	OEM Reference	Notes
12000	EFA-12F4	E-4615 Curbside	5.44"	1006148/37024-0004	
		E-4614 Roadside		1006149/37024-0005	
		E-8758 Curbside	8.125"	1009010	
		E-8757 Roadside		1009009	
12000, 14600	FF961, FG943	E-4615 Curbside	5.44"	1006148/37024-0004	
		E-4614 Roadside		1006149/37024-0005	
12000	VF12	E-10163 Curbside	4.72"	1698847	
		E-10164 Roadside		1698846	
16000, 18000, 20000	FL941, FL943	E-4617 Curbside	5.75"	A3144J296	
		E-4616 Roadside		A3144K297	
		E-4629 Curbside	7.37"	37024-5002	
		E-4628 Roadside		37024-5001	
		E-6856 Curbside	12.688"	A3144D550	
		E-6857 Roadside		A3144C549	

WHR, WIL, WIA, Series

King Pin Kits

Axle Rating Lbs.	Axle Code/Year	Part Number/ Bushings Type	King Pin Size	Type	OEM Reference	Notes
12000	EFA-12F4	E-4696B Bronze	1.625" x 9.195"	A	806355	
		E-4696C Composite				
	FF943	E-4468B Bronze	1.794" x 10.392"	B	KIT 195	
		E-4694C Composite			KIT 1307	
	FF961	E-6199C Composite			KIT 1315	
14600	FG943	E-4695C Composite	1.794" x 10.392"	B	KIT 1309	
		E-6868B Bronze			KIT 1310	

WHR, WIL, WIA, Series (Continued)

Tie Rod Ends

Axle Rating Lbs.	Axle Code/Year	Part Number/Location	Stud Center to Rod End	OEM Reference	Notes
12000	EFA-12F4	E-4615 Curbside	5.44"	1006148/37024-0004	
		E-4614 Roadside		1006149/37024-0005	
		E-8758 Curbside	8.125"	1009010	
		E-8757 Roadside		1009009	
12000, 14600	FF943, FF961, FG943	E-4615 Curbside	5.44"	1006148/37024-0004	
		E-4614 Roadside		1006149/37024-0005	

XPEDITOR

King Pin Kits

Axle Rating Lbs.	Axle Code/Year	Part Number/Bushing Type	King Pin Size	Type	OEM Reference	Notes
12000	FF943	E-4468B Bronze	1.794" x 10.392"	B	KIT 195	
		E-4694C Composite			KIT 1307	
14000	VF14	E-10166N Nylon	9.875"	F	3090266	Tapered pin.
14600	FG943	E-4695C Composite	1.794" x 10.392"	B	KIT 1309	
		E-6868B Bronze			KIT 1310	
16000, 18000, 20000	FL941, FL943	E-4458B Bronze	1.999" x 11.212"	B	KIT 198	
		E-4458C Composite			KIT 1312	
18000	VF18	E-10166N Nylon	9.875"	F	3090266	Tapered pin.

Tie Rod Ends

Axle Rating Lbs.	Axle Code/Year	Part Number/Location	Stud Center to Rod End	OEM Reference	Notes
12000, 14600	FF943, FG943	E-4615 Curbside	5.44"	1006148/37024-0004	
		E-4614 Roadside		1006149/37024-0005	
14000	VF14	E-10163 Curbside	4.72"	1698847	
		E-10164 Roadside		1698846	
16000, 18000, 20000	FL941, FL943	E-4617 Curbside	5.75"	A3144J296	
		E-4616 Roadside		A3144K297	
		E-4629 Curbside	7.37"	37024-5002	
		E-4628 Roadside		37024-5001	
		E-6856 Curbside	12.688"	A3144D550	
		E-6857 Roadside		A3144C549	
18000	VF18	E-10163 Curbside	4.72"	1698847	
		E-10164 Roadside		1698846	

Drag Links

Axle Rating Lbs.	Axle Code/Year	Part Number	Stud Center to Stud Center	OEM Reference	Notes
All		E-5402	5.75" Stud center to rod end	02-7092963	Drag link end. Use w/E-6806 – RH thread.
		E-6806	18.38"	38905-0001	



an **ArvinMeritor**™ brand

WESTERN STAR

INDEX

Model	Page No.
All	11-185

Model	Page No.

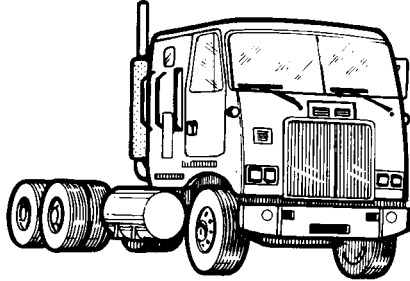

WESTERN STAR COE

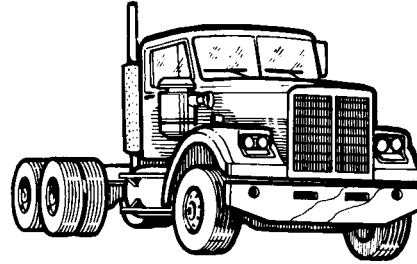

WESTERN STAR CONVENTIONAL

King Pin Kits

Axle Rating Lbs.	Axle Code/Year	Part Number/ Bushings Type	King Pin Size	Type	OEM Reference	Notes
12000	EFA-12F4	E-4696B Bronze	1.625" x 9.195"	A	806355	
		E-4696C Composite				
	FF961	E-6199B Bronze	1.794" x 10.392"	B	KIT 1315	
		E-6199C Composite				
14600	FG941	E-4695C Composite	1.794" x 10.392"	B	KIT 1309	
		E-6868B Bronze			KIT 1310	
16000, 18000, 20000	FL941	E-4458B Bronze	1.999" x 11.212"	B	KIT 198	
		E-4458C Composite			KIT 1312	

Tie Rod Ends

Axle Rating Lbs.	Axle Code/Year	Part Number/ Location	Stud Center to Rod End	OEM Reference	Notes
12000	EFA-12F4	E-4615 Curbside	5.44"	1006148	
		E-4614 Roadside		1006149	
		E-8758 Curbside	8.125"	1009010	
		E-8757 Roadside		1009009	
14600	FF961, FG941	E-4615 Curbside	5.44"	1006148	
		E-4614 Roadside		1006149	
16000, 18000, 20000	FL941	E-4617 Curbside	5.75"	A3144J296	
		E-4616 Roadside		A3144K297	
		E-4629 Curbside	7.37"	A3144F448	
		E-4628 Roadside		A3144G449	
		E-6856 Curbside	12.688"	A3144D550	
		E-6857 Roadside		A3144C549	

S.O.S.

Special Order Service

Can't find it?

Trouble sourcing products?

Need assistance?

*Let Euclid's Special Order Service (**S.O.S.**) help you find your parts.*

Euclid's position as the market leader provides you access to a comprehensive array of truck parts products from the industry's leading manufacturers. Through Euclid, these entire product lines are available to you just by placing a phone call to Euclid's S.O.S. Department at 866-238-2543 (option 2) in the U.S. or 800-387-3889 in Canada.

INDEX

Model	Page No.	Model	Page No.
All	11-187		



an **ArvinMeritor**™ brand

For additional: Parts Information
Cross Reference
Production Bills of Material

visit our online catalog at: www.XpresswayPlus.com

King Pin Kits

Axle Rating Lbs.	Axle Code/Year	Part Number/ Bushing Type	King Pin Size	Type	OEM Reference	Notes
13200, 14600	F3W-1200, F5W-1200, F6W-1200	E-4451B Bronze	1.609" x 9.660"	B	216446	
		E-4470B Bronze	1.810" x 10.531"	A	217175	
		E-4471B Bronze			37090-5005	
16000	F3W-1600, F6W-1600	E-4471B Bronze	1.810" x 10.531"	A	37090-4405	Western Star (WS-16 Axle)

Tie Rod Ends

Axle Rating Lbs.	Axle Code/Year	Part Number/ Location	Stud Center to Rod End	OEM Reference	Notes
9000	F3W-1200, F5W-0900, F5W-1200, F6W-1200	E-4615 Curbside	5.44"	37025-0005	
		E-4614 Roadside		37025-0004	
13200, 14600, 16000	F3W-1400, F5W-1400, F6W-1400, WS-16	E-4616 Roadside	5.75"	143640-004	Western Star (WS-16 Axle) 839307B
		E-4617 Curbside		143640-005	Western Star (WS-16 Axle) 839308B

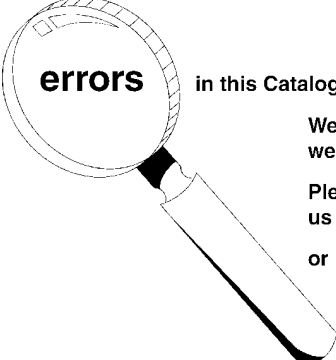

If you detect any **errors** in this Catalog, please let us know.

We want the information to be as accurate as possible; we appreciate your help in making it so.

Please e-mail any comments/suggestions/corrections to us at: catalogfeedback@arvinmeritor.com

or mail to: **Euclid Industries, LLC**
Attn: Catalog Dept.
7975 Dixie Highway
Florence, KY 41042-2754



an **ArvinMeritor™** brand

INDEX

Model	Page No.	Model	Page No.
FDS1805FWD, FDS1807FWD	11-189	WFC-12042T, WFC-12064, WFC-12064T	11-190
RB2-42T, RC2-42T, RX2-42T, RB2-64T, RC2-64T, RX2-64T, 4842, 4864, 4942, 4964	11-189	WFP-6342T, WFT-6342T, WFP-6364, WFP-6364T, WFT-6364, WFP-6364T, WFP-7564T, WFT-7564T, WFT-8164T, WFT-9664T	11-191
RBW-42T, RCS-42T, WSH-42T, RBW-64T, RCW-64T, WSH-64T	11-189	White Axles	11-192

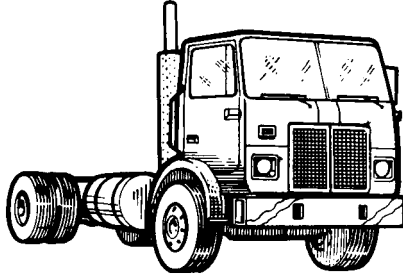

ROAD XPEDITOR 2

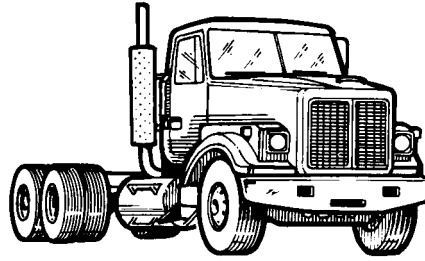

ROAD BOSS 2

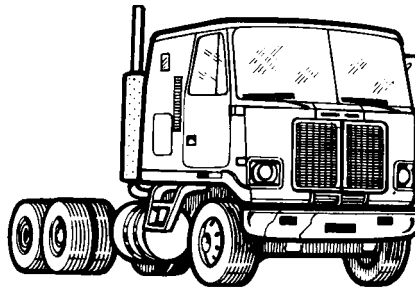

ROAD COMMANDER 2

FDS1805FWD, FDS1807FWD

Tie Rod Ends

Axle Rating Lbs.	Axle Code/Year	Part Number/ Location	Stud Center to Rod End	OEM Reference	Notes
18000		E-4619 Roadside	5.75"	A3144C237	Front drive axle. 1.25"-12 RH thread.
		E-4642 Curbside		A1-3144F370	Front drive axle. 1.25"-16 RH thread.
		E-6858 Roadside		A3144E551	Front drive axle. 1.25"-18 RH thread.

RB2-42T, RC2-42T, RX2-42T, RB2-64T, RC2-64T, RX2-64T, 4842, 4864, 4942, 4964

King Pin Kits

Axle Rating Lbs.	Axle Code/Year	Part Number/ Bushing Type	King Pin Size	Type	OEM Reference	Notes
12000	F6W-1200, FF933	E-4471B Bronze	1.810" x 10.531"	A	37090-5005	Thrust bearing O.D. is 3.365".
		E-4468B Bronze	1.794" x 10.392"	B	KIT 195	
		E-4694C Composite			KIT 1307	
14000	F6W-1400	E-4470B Bronze	1.810" x 10.531"	A	217175	
20000	FL931	E-4458B Bronze	1.999" x 11.212"	B	KIT 198	
		E-4458C Composite			KIT 1312	

Tie Rod Ends

Axle Rating Lbs.	Axle Code/Year	Part Number/ Location	Stud Center to Rod End	OEM Reference	Notes
12000	F6W-1200, FF933	E-4615 Curbside	5.44"	37024-0005	
		E-4614 Roadside		37024-0004	
14000	F6W-1400	E-4617 Curbside	5.75"	839307B	
		E-4616 Roadside		839308B	
20000	FL931	E-4617 Curbside	5.75"	839307B	
		E-4616 Roadside		839308B	
		E-4629 Curbside	7.37"	37024-5002	
		E-4628 Roadside	37024-5001		
		E-6856 Curbside	12.688"	A3144D550	
		E-6857 Roadside	A3144C549		

Drag Links

Axle Rating Lbs.	Axle Code/Year	Part Number	Stud Center to Stud Center	OEM Reference	Notes
		E-5391	5.75" Stud center to rod end	02-7092962	Drag link end. Use w/E-6806 - LH thread.
		E-5402		02-7092963	Drag link end. Use w/E-6806 - RH thread.
		E-6806	18.38"	38905-0001	

RBW-42T, RCS-42T, WSH-42T, RBW-64T, RCW-64T, WSH-64T

King Pin Kits

Axle Rating Lbs.	Axle Code/Year	Part Number/ Bushing Type	King Pin Size	Type	OEM Reference	Notes
12000	F3W-1200	E-4471B Bronze	1.810" x 10.531"	A	37090-5005	
		E-4468B Bronze				
	E-4694C Composite	KIT 1307				
	FF933	E-4468B Bronze	KIT 195			
14000	F3W-1400	E-4694C Composite	1.810" x 10.531"	A	KIT 1307	
		E-4470B Bronze			217175	

WHITE

RBW-42T, RCS-42T, WSH-42T, RBW-64T, RCW-64T, WSH-64T (Continued)

Tie Rod Ends

Axle Rating Lbs.	Axle Code/Year	Part Number/Location	Stud Center to Rod End	OEM Reference	Notes
12000	F3W-1200, FF931	E-4615 Curbside	5.44"	37024-0005	
		E-4614 Roadside		37024-0004	
	FF933	E-4615 Curbside		37024-0005	
	E-4614 Roadside	37024-0004			
14000	F3W-1400	E-4617 Curbside	5.75"	839307B	
		E-4616 Roadside		839308B	

Drag Links

Axle Rating Lbs.	Axle Code/Year	Part Number	Stud Center to Stud Center	OEM Reference	Notes
		E-5391	5.75" Stud center to rod end	02-7092962	Drag link end. Use w/E-6806 - LH thread.
		E-5402		02-7092963	Drag link end. Use w/E-6806 - RH thread.
		E-6806	18.38"	38905-0001	

WFC-12042T, WFC-12064, WFC-12064T

King Pin Kits

Axle Rating Lbs.	Axle Code/Year	Part Number/Bushing Type	King Pin Size	Type	OEM Reference	Notes
12000	(FE900)	E-4434B Bronze	9.750"	D	KIT 144	Tapered pin.
		E-4434N Bronze, Nylon			KIT 123	
	(FE970)	E-4449B Bronze	1.607" x 8.740"	B	KIT 157	
	(FF901)	E-4442B Bronze	1.794" x 9.120"		KIT 172	
	(FF921)	E-4450B Bronze	1.794" x 10.410"		KIT 193	
	(FF931)	E-4468B Bronze	1.794" x 10.392"		KIT 195	
		E-4694C Composite		KIT 1307		
16000	(FH901)	E-4454B Bronze	1.999" x 11.040"	B	KIT 170	
		E-4454N Nylon			KIT 168	
	(FL931)	E-4458B Bronze	1.999" x 11.212"		KIT 198	
		E-4458C Composite			KIT 1312	
18000	(FL901)	E-4454B Bronze	1.999" x 11.040"	B	KIT 170	
		E-4454N Nylon			KIT 168	

If you detect any **errors** in this Catalog, please let us know.

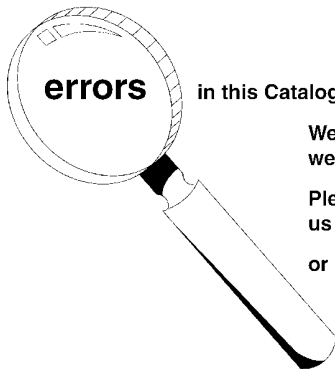

We want the information to be as accurate as possible; we appreciate your help in making it so.

Please e-mail any comments/suggestions/corrections to us at: catalogfeedback@arvinmeritor.com

or mail to: **Euclid Industries, LLC**
Attn: Catalog Dept.
7975 Dixie Highway
Florence, KY 41042-2754

WFC-12042T, WFC-12064, WFC-12064T (Continued)

Tie Rod Ends

Axle Rating Lbs.	Axle Code/Year	Part Number/ Location	Stud Center to Rod End	OEM Reference	Notes	
12000	(FE900), (FE970)	E-4611 Curbside	4.875"	A3144R226		
		E-4610 Roadside		A3144Q225		
		E-6848 Curbside	10.50"	A3144N534		
		E-6847 Roadside		A3144M533		
	(FF901)	E-4611 Curbside	4.875"	A3144R226		
		E-4610 Roadside		A3144Q225		
		E-4618 Curbside	5.75"	A3144D238		Anti-tilt seal type.
		E-4619 Roadside		A3144C237		
		E-4617 Curbside		A3144J296		Conventional seal type.
		E-4616 Roadside		A3144K297		
		(FF921), (FF931)	E-6848 Curbside	10.50"		A3144N534
			E-6847 Roadside			A3144M533
		E-4615 Curbside	5.44"	A3144D524		Greaseable seal type.
		E-4614 Roadside		A3144E525		
16000	(FH901)	E-4617 Curbside	5.75"	A3144J296		
		E-4616 Roadside		A3144K297		
	(FL931)	E-4617 Curbside	7.37"	839307B		
		E-4616 Roadside		839308B		
		E-4629 Curbside		A3144U437		
		E-4628 Roadside		A3144V438		
		E-6856 Curbside	12.688"	A3144D550		
		E-6857 Roadside		A3144C549		
		18000	(FL901)	E-4617 Curbside	5.75"	A3144J296
				E-4616 Roadside		A3144K297

Drag Links

Axle Rating Lbs.	Axle Code/Year	Part Number	Stud Center to Stud Center	OEM Reference	Notes
12000, 16000, 18000	(All)	E-5391	5.75" Stud center to rod end	L28SV5019A1	Drag link end - LH thread
		E-9877		L28SV5004D1	Drag link end - RH thread

WFP-6342T, WFT-6342T, WFP-6364, WFP-6364T, WFT-6364, WFP-6364T, WFP-7564T, WFT-7564T, WFT-8164T, WFT-9664T

King Pin Kits

Axle Rating Lbs.	Axle Code/Year	Part Number/ Bushing Type	King Pin Size	Type	OEM Reference	Notes
12000	(FE900)	E-4434B Bronze	9.750"	D	KIT 144	Tapered pin.
		E-4434N Bronze, Nylon			KIT 123	
	(FE970)	E-4449B Bronze	1.607" x 8.740"	B	KIT 157	
	(FF901)	E-4442B Bronze	1.794" x 9.120"		KIT 172	
	(FF921)	E-4450B Bronze	1.794" x 10.410"		KIT 193	
	(FF931)	E-4468B Bronze	1.794" x 10.392"		KIT 195	
		E-4694C Composite			KIT 1307	
	16000	(FH901)	E-4454B Bronze		1.999" x 11.040"	B
E-4454N Nylon			KIT 168			
(FL931)		E-4458B Bronze	1.999" x 11.212"	KIT 198		
		E-4458C Composite		KIT 1312		
18000	(FL901)	E-4454B Bronze	1.999" x 11.040"	B	KIT 170	
		E-4454N Nylon			KIT 168	

WHITE

WFP-6342T, WFT-6342T, WFP-6364, WFP-6364T, WFT-6364, WFP-6364T, WFP-7564T, WFT-7564T, WFT-8164T, WFT-9664T (Continued)

Tie Rod Ends

Axle Rating Lbs.	Axle Code/Year	Part Number/ Location	Stud Center to Rod End	OEM Reference	Notes	
12000	(FE900), (FE970)	E-4611 Curbside	4.875"	A3144R226		
		E-4610 Roadside		A3144Q225		
	(FF901)	E-4611 Curbside	5.75"	A3144R226		Anti-tilt seal type.
		E-4610 Roadside		A3144Q225		
	(FF921), (FE931)	E-4618 Curbside	5.44"	A3144D238	Conventional seal type.	
		E-4619 Roadside		A3144C237		
		E-4617 Curbside		A3144J296	Greaseable seal type.	
		E-4616 Roadside		A3144K297		
	16000	(FH901)	E-4617 Curbside	5.75"	A3144J296	
			E-4616 Roadside		A3144K297	
(FL931)		E-4629 Curbside	7.37"	A3144V437		
		E-4628 Roadside		A3144U438		
18000		(FL901)	E-4617 Curbside	5.75"	A3144J296	
			E-4616 Roadside		A3144K297	

White Axles

King Pin Kits

Axle Rating Lbs.	Axle Code/Year	Part Number/ Bushing Type	King Pin Size	Type	OEM Reference	Notes
12000	F120, F3-120, F3W-120, F5-120, F5W-120, F6W-120	E-4451B Bronze	1.609" x 9.660"	B	216446	
14000	F3W-140, F5-140, F5W-140, F6W-140	E-4451B Bronze	1.609" x 9.660"	B	216446	
		E-4470B Bronze	1.810" x 10.531"	A	217175	

S.O.S.

Special Order Service

Can't find it?

Trouble sourcing products?

Need assistance?

*Let Euclid's Special Order Service (**S.O.S.**) help you find your parts.*

Euclid's position as the market leader provides you access to a comprehensive array of truck parts products from the industry's leading manufacturers. Through Euclid, these entire product lines are available to you just by placing a phone call to Euclid's S.O.S. Department at 866-238-2543 (option 2) in the U.S. or 800-387-3889 in Canada.

The logo for Euclid, featuring the word "EUCLID" in a bold, stylized font with a thick black outline, set against a white background.

ALPHABETICAL INDEX OF EUCLID PART NUMBERS			
EUCLID NO.	PAGE	EUCLID NO.	PAGE
E-4741	1-90	E-4752	1-93
E-4742	1-90	E-4753	1-93
E-4743	1-91	E-4754	1-94
E-4744	1-91	E-4755	1-94
E-4745	1-91	E-4756	1-94
E-4746	1-91	E-4757	1-95
E-4746	1-92	E-4758	1-95
E-4747	1-92	E-4759	1-95
E-4748	1-92	E-4760	1-96
E-4750	1-93	E-4761	1-96
		E-4762	1-96

WARRANTY

Products are engineered to provide the longest life possible under normal operating conditions as loads carried vs. space (diameter) allowed by the suspension designer. While service life from vibration and an air spring is usually measured in "years" of service, the actual life may vary by thousands of miles.

Products sold by Euclid Industries, Inc. are warranted against material and workmanship but such products are not warranted against application or use. Any products returned for warranty approval will make an adjustment at the discretion of Euclid Industries, Inc.

- INTERCHANGE
- PART NUMBER INDEX
- EUCLID WARRANTY

REFERENCE SECTION M

S.O.S.

Special Order Service

Can't find it? Trouble sourcing parts? Need assistance?

Let Euclid's Special Order Service (S.O.S.) help.

Euclid's position as the market leader provides you access to the products and manufacturers listed below. These entire product lines are available to you by just placing a phone call to Euclid's S.O.S. Department at 866-238-2543 (option 2) in the U.S. or 800-387-3889 in Canada.

AIR BRAKE PARTS

Anchorlok
Bendix (Allied Signal)
Brake Shoes
Camshafts
Dana
Fruehauf
Haldex

HYDRAULIC BRAKE PARTS

Calipers - New & Remanufactured
Clutch Master Cylinders
Clutch Slave Cylinders
Dayton
EIS
Lucas
Master Cylinders
Rotors
Wagner Brake
Wheel Cylinders

FRICTION MATERIAL

Performance Friction
Tenneco HD Brake/CM

WHEEL & HUB PARTS

ConMet
Gunite
Webb Wheel

SHOCK ABSORBERS & AIR SPRINGS

Gabriel
Firestone
Neway
Monroe
Others

SUSPENSION PARTS

Binkley
Cambria
Chalmers
Fruehauf
Hendrickson
Hendrickson Turner
Hutchens
Kwik-Loc (Jifflox)
Neway
Page
Reyco/Transpro
Ridewell
Suspensions Incorporated
Torque Arms
Trailmobile

Full Suspensions Are Available

FRONT END PARTS

King Pin Kits
Tie Rod Ends
Drag Link Ends
Drag Links

AIR CONDITIONING & HEATING PARTS

Air Source
Robinair

TOOLS & SHOP EQUIPMENT

Fraser Gauge Company
Kent Moore
Ken Tool
OTC (Owatonna Tool Company)
Tiger Tool

Don't miss the sale! Call Euclid's Special Order Service.

INTERCHANGE

Part Number	Supplier	Euclid Number	Part Number	Supplier	Euclid Number
027092962	Volvo White GMC	E-5391	15622057	GMC	E-6834
027092963	Volvo White GMC	E-5402	15622068	GMC	E-6854
1006148	Eaton	E-4614	15622069	GMC	E-6855
1006149	Eaton	E-4615	15625713	GMC	E-6833
1008431	Eaton	E-4696C	1643277	Chrysler	E-4611
1009009	Eaton	E-8757	1643278	Chrysler	E-4610
1009010	Eaton	E-8758	1649637C91	Navistar	E-4630
102163	Peterbilt	E-6818	1649638C91	Navistar	E-4631
102260	Peterbilt	E-6819	1658897C91	Navistar	E-9948
102498	Peterbilt	E-6818	1658934C91	Navistar	E-6875C
10QH242P1	Mack	E-4611	1658934C92	Navistar	E-6875C
10QH243P1	Mack	E-4640	1658934C93	Navistar	E-4451B
10QH243P2	Mack	E-4610	1658934C93	Navistar	E-4693B
10QH248	Mack	E-4611	1658934C93	Navistar	E-6875C
10QH248P3	Mack	E-9877	1658946C91	Navistar	E-6135
10QH248P4	Mack	E-9878	1658947C91	Navistar	E-6136
10QH310P1	Mack	E-4616	1660271C91	Navistar	E-6198B
10QH310P1	Mack	E-9878	1660271C92	Navistar	E-6198B
10QH311P1	Mack	E-4629	1661437C92	Navistar	E-9911
10QH311P1	Mack	E-9879	1662305C91	Navistar	E-4434B
10QH312P1	Mack	E-4628	1662305C91	Navistar	E-4434N
10QH312P1	Mack	E-9880	1662306C91	Navistar	E-4450B
10QH39P1	Mack	E-4617	1665531C91	Navistar	E-6199C
10QH39P1	Mack	E-9877	1668407C91	Navistar	E-4614
110362R92	Navistar	E-4610	1668408C91	Navistar	E-4615
110363R92	Navistar	E-4611	1668409C91	Navistar	E-9951
1160271C92	Navistar	E-6198B	1668410C91	Navistar	E-9952
1243756	Chrysler	E-4636	1668411C91	Navistar	E-4442B
12540328	GMC	E-10104B	1668411C91	Navistar	E-9941B
12540329	GMC	E-10105B	1668412C91	Navistar	E-9942B
12540330	GMC	E-10106B	1668480C91	Navistar	E-6856
12541348	GMC	E-6194B	1677271C91	Navistar	E-4629
12548107	GMC	E-10108	1698846	Volvo White GMC	E-10163
12548108	GMC	E-10109	1698847	Volvo White GMC	E-10164
12548110	GMC	E-10110	171060	Batco	E-4462B
12548111	GMC	E-10111	171061	Batco	E-4462B
12549192	GMC	E-6854	171140	Batco	E-4449B
12549193	GMC	E-6855	171141	Batco	E-4449B
13606	TRW	E-4572	171150	Batco	E-4451B
13607	TRW	E-4573	171158	Batco	E-4442B
13609	TRW	E-4575	171164	Batco	E-4459B
13610	TRW	E-4576	171172	Batco	E-4450B
13611	TRW	E-4577	171174	Batco	E-4468B
13613	TRW	E-4579	171178	Batco	E-4454B
13614	TRW	E-4580	171179	Batco	E-4454N
13615	TRW	E-4581	171180	Batco	E-4458B
13616	TRW	E-4582	171230	Batco	E-4434B
13617	TRW	E-4583	171231	Batco	E-4434N
14021192	GMC	E-6720	171260	Batco	E-4467B
14026802	GMC	E-6722	171294	Batco	E-4469B
1412098001	Freightliner	E-9897	1795584	Chrysler	E-4636
15501673	GMC	E-6815	1818854	Chrysler	E-4603
15501674	GMC	E-6817	1818855	Chrysler	E-4602
15506689	GMC	E-6816	18QK201M2	Mack	E-9881
15510849	GMC	E-4468B	18QK204M2	Mack	E-9881
15510849	GMC	E-4694C	18QK214P2	Mack	E-4617
15515804	GMC	E-4614	18QK23A	Mack	E-4617
15515805	GMC	E-4615	18QK28A	Mack	E-4616
15536398	GMC	E-4453B	18QK29301	Mack	E-4617
15584763	GMC	E-6454C	2007728	GMC	E-4609
15585841	GMC	E-4458C	2007731	GMC	E-4608
15619287	GMC	E-10112	2010021	GMC	E-4468B
15619288	GMC	E-10113	201230	Batco	E-6453B

INTERCHANGE

Part Number	Supplier	Euclid Number	Part Number	Supplier	Euclid Number
202020	Batco	E-6451B	212027L	Batco	E-6404
202030	Batco	E-6450B	212033L	Batco	E-4628
202070	Batco	E-4430B	212035L	Batco	E-4622
202081	Batco	E-4444B	212036R	Batco	E-4623
202082	Batco	E-4444N	212041L	Batco	E-4616
202190	Batco	E-4453B	212061L	Batco	E-4612
202201	Batco	E-4445B	212062R	Batco	E-4613
202203	Batco	E-4445N	212069R	Batco	E-4609
202211	Batco	E-4440B	212070L	Batco	E-4608
202241	Batco	E-4438B	212090L	Batco	E-4628
202243	Batco	E-4438N	212091R	Batco	E-4629
202271	Batco	E-4431B	212115R	Batco	E-4617
202281	Batco	E-4443B	212116L	Batco	E-4616
202282	Batco	E-4443N	212118L	Batco	E-4640
202330	Batco	E-4460B	212147RL	Batco	E-6678
202340	Batco	E-4441B	212202R	Batco	E-4629
202341	Batco	E-4441B	212204R	Batco	E-4629
202350	Batco	E-4452B	212207R	Batco	E-4618
202360	Batco	E-4448B	212209R	Batco	E-4629
202370	Batco	E-4461B	212224L	Batco	E-5391
202390	Batco	E-4457B	212225R	Batco	E-5402
202410	Batco	E-4595B	212234R	Batco	E-6722
202420	Batco	E-4449B	21235NL	Batco	E-4600
202421	Batco	E-4449B	21235NR	Batco	E-4601
202430	Batco	E-4697B	212613L	Batco	E-5469
202440	Batco	E-4463B	212614R	Batco	E-5470
202450	Batco	E-4463B	212847R	Batco	E-6774
202470	Batco	E-4693B	212914R	Batco	E-6789
202480	Batco	E-4462B	213030R	Batco	E-6856
202481	Batco	E-4462B	213031L	Batco	E-6857
202490	Batco	E-4451B	213032R	Batco	E-6858
202520	Batco	E-4469B	213034R	Batco	E-4629
202530	Batco	E-4442B	21304L	Batco	E-4602
202560	Batco	E-4459B	21304R	Batco	E-4603
202570	Batco	E-4450B	21330L	Batco	E-4620
202590	Batco	E-4694C	21330R	Batco	E-4621
202610	Batco	E-4468B	21332L	Batco	E-4624
202620	Batco	E-4470B	21332R	Batco	E-4625
202630	Batco	E-4598B	21346L	Batco	E-4618
202650	Batco	E-4471B	21346R	Batco	E-4619
202670	Batco	E-4458B	21373L	Batco	E-4604
202671	Batco	E-4458B	21373R	Batco	E-4605
202680	Batco	E-4454B	21376L	Batco	E-4616
202681	Batco	E-4454N	21405L	Batco	E-4606
202820	Batco	E-4467B	21405R	Batco	E-4607
202840	Batco	E-4435B	21411L	Batco	E-4630
202841	Batco	E-4435N	21411R	Batco	E-4631
202850	Batco	E-4599B	21423L	Batco	E-4614
202870	Batco	E-4434B	21423R	Batco	E-4615
202871	Batco	E-4434N	21431R	Batco	E-4616
2037140	GMC	E-4609	216446	Volvo White GMC	E-4598B
2037142	GMC	E-4608	217175	Volvo White GMC	E-4470B
2055523	GMC	E-6847	219403R91	Navistar	E-4636
2055524	GMC	E-6848	219404R91	Navistar	E-4637
205SQ12	Mack	E-4454N	221020	Batco	E-5386
21150L	Batco	E-4634	221028	Batco	E-6808
21150R	Batco	E-4635	221064	Batco	E-6816
21176L	Batco	E-4636	221180	Batco	E-6819
21187L	Batco	E-4610	221191	Batco	E-6827
21187R	Batco	E-4611	221199	Batco	E-6833
212010L	Batco	E-6665	22800	Batco	E-5310
212011R	Batco	E-6720	22908	Batco	E-5325
212026R	Batco	E-6403	22910	Batco	E-5326

INTERCHANGE

Part Number	Supplier	Euclid Number	Part Number	Supplier	Euclid Number
22948	Batco	E-5338	2621559	Perfect Circle	E-4462B
22949	Batco	E-5339	2621560	Perfect Circle	E-4463B
22953	Batco	E-5342	2621561	Perfect Circle	E-4463B
22979	Batco	E-5366	2621563	NAPA United	E-6450B
22986	Batco	E-5372	2621563	Perfect Circle	E-6450B
22987	Batco	E-5373	2621569	Perfect Circle	E-4467B
22988	Batco	E-5374	2621572	Perfect Circle	E-4468B
22992	Batco	E-5378	2621576	Perfect Circle	E-4471B
22993	Batco	E-5379	2621577	Perfect Circle	E-4470B
22994	Batco	E-5380	2621579	Perfect Circle	E-4697B
2330712	GMC	E-4637	2621580	Perfect Circle	E-4595B
2330713	GMC	E-4636	2621582	Perfect Circle	E-4469B
2362836	GMC	E-4636	2621583	Perfect Circle	E-6868B
2452860	GMC	E-4617	2621584	Perfect Circle	E-4693B
2452861	GMC	E-4616	2621585	Perfect Circle	E-4696C
2456810	GMC	E-4610	2621586	Perfect Circle	E-6869C
2456811	GMC	E-4611	2621587	Perfect Circle	E-6455C
2466811	GMC	E-4611	2621588	Perfect Circle	E-6454C
2521013	GMC	E-4435B	2621590	Perfect Circle	E-4458C
2621012	Perfect Circle	E-4430B	2621591	Perfect Circle	E-4599B
2621016	Perfect Circle	E-4444B	2621592	Perfect Circle	E-4695C
2621017	Perfect Circle	E-4443B	2621593	Perfect Circle	E-4694C
2621018	Perfect Circle	E-4445B	2621594	Perfect Circle	E-6194C
2621275	Perfect Circle	E-6865B	2621597	Perfect Circle	E-6195B
2621336	Perfect Circle	E-4431B	2621600	Perfect Circle	E-4459C
2621364	Perfect Circle	E-4434B	2621603	Perfect Circle	E-6198B
2621406	Perfect Circle	E-4435B	2621604	Perfect Circle	E-6199C
2621407	Perfect Circle	E-5441B	2621611	Perfect Circle	E-6454C
2621414	Perfect Circle	E-4441B	2621635	Dana/Spicer	E-9941B
2621421	Perfect Circle	E-4438B	2627036	Perfect Circle	E-4575
2621422	Perfect Circle	E-4434N	2627037	Perfect Circle	E-4572
2621425	Perfect Circle	E-4441B	2627038	Perfect Circle	E-4576
2621431	Perfect Circle	E-4438N	2627042	Perfect Circle	E-4579
2621443	Perfect Circle	E-4598B	2627065	Perfect Circle	E-4582
2621461	Perfect Circle	E-4440B	2627073	Perfect Circle	E-4580
2621463	Perfect Circle	E-4444B	2627080	Perfect Circle	E-4581
2621467	Perfect Circle	E-4435N	2627082	Perfect Circle	E-4583
2621472	Perfect Circle	E-4444N	2627090	Perfect Circle	E-4573
2621473	Perfect Circle	E-4443N	2627091	Perfect Circle	E-4577
2621475	Perfect Circle	E-4430B	263498C91	Navistar	E-4600
2621483	Perfect Circle	E-4445N	263499C91	Navistar	E-4601
2621491	Perfect Circle	E-4451B	2692022	Perfect Circle	E-4634
2621506	Perfect Circle	E-4449B	2692023	Perfect Circle	E-4635
2621507	Perfect Circle	E-4442B	2692032	NAPA United	E-4636
2621509	Perfect Circle	E-4448B	2692032	Perfect Circle	E-4636
2621512	Perfect Circle	E-4454N	2692033	Perfect Circle	E-4637
2621513	Perfect Circle	E-4454B	2692041	NAPA United	E-4610
2621514	Perfect Circle	E-4449B	2692041	Perfect Circle	E-4610
2621524	NAPA United	E-6453B	2692042	Perfect Circle	E-4611
2621524	Perfect Circle	E-6453B	2692051	Perfect Circle	E-4600
2621525	Perfect Circle	E-4450B	2692052	Perfect Circle	E-4601
2621537	Perfect Circle	E-4452B	2692097	Perfect Circle	E-4602
2621548	NAPA United	E-4453B	2692098	Perfect Circle	E-4603
2621548	Perfect Circle	E-4453B	2692138	Perfect Circle	E-4620
2621549	NAPA United	E-6451B	2692139	Perfect Circle	E-4621
2621549	Perfect Circle	E-6451B	2692142	Perfect Circle	E-4624
2621550	NAPA United	E-4459B	2692143	Perfect Circle	E-4625
2621550	Perfect Circle	E-4459B	2692158	Perfect Circle	E-4618
2621551	Perfect Circle	E-4457B	2692159	Perfect Circle	E-4619
2621554	Perfect Circle	E-4458B	2692189	Perfect Circle	E-4604
2621555	Perfect Circle	E-4460B	2692190	Perfect Circle	E-4605
2621557	Perfect Circle	E-4461B	2692234	Perfect Circle	E-4630
2621558	Perfect Circle	E-4462B	2692235	Perfect Circle	E-4631

INTERCHANGE

Part Number	Supplier	Euclid Number	Part Number	Supplier	Euclid Number
2692243	Perfect Circle	E-4614	2721582	Perfect Circle	E-5372
2692244	Perfect Circle	E-4615	2721583	Perfect Circle	E-5366
2692311	Perfect Circle	E-4616	2721590	Perfect Circle	E-5339
2692311	Perfect Circle	E-4617	2721593	Perfect Circle	E-6815
2692312	Perfect Circle	E-4616	2721600	Perfect Circle	E-5338
2692314	Perfect Circle	E-4606	2721602	Perfect Circle	E-6817
2692315	Perfect Circle	E-4607	2721604	Perfect Circle	E-5390
2692337	NAPA United	E-6720	2721608	Perfect Circle	E-6835
2692337	Perfect Circle	E-6720	2721620	Perfect Circle	E-5386
2692432	Perfect Circle	E-5392	2721623	Perfect Circle	E-6804
2692437	Perfect Circle	E-4622	2721624	Perfect Circle	E-6806
2692438	Perfect Circle	E-4623	2721626	Perfect Circle	E-6808
2692441	NAPA United	E-6403	2721628	Perfect Circle	E-6878
2692441	Perfect Circle	E-6403	2721646	Perfect Circle	E-6827
2692442	NAPA United	E-6404	2721650	Perfect Circle	E-6833
2692442	Perfect Circle	E-6404	2721651	Perfect Circle	E-6834
2692446	Perfect Circle	E-4616	2721652	Perfect Circle	E-6818
2692447	Perfect Circle	E-4617	2721654	Perfect Circle	E-6836
2692448	NAPA United	E-6665	2724124	Perfect Circle	E-5378
2692448	Perfect Circle	E-6665	2724125	Perfect Circle	E-5380
2692466	Perfect Circle	E-4612	2724126	Perfect Circle	E-5379
2692467	NAPA United	E-4613	2724148	Perfect Circle	E-5342
2692467	Perfect Circle	E-4613	2724179	Perfect Circle	E-6825
2692474	Perfect Circle	E-4609	2724182	Perfect Circle	E-6819
2692475	Perfect Circle	E-4608	2724183	Perfect Circle	E-6835
2692485	Perfect Circle	E-4629	2724186	Perfect Circle	E-6839
2692486	Perfect Circle	E-4628	276193	Volvo White GMC	E-10166N
2692491	NAPA United	E-6678	300-297	Dayton Parts	E-11394B
2692491	Perfect Circle	E-6678	300103	Dayton Parts	E-6865B
2692553	NAPA United	E-6722	300107	Dayton Parts	E-4430B
2692553	Perfect Circle	E-6722	300110	Dayton Parts	E-4431B
2692644	Perfect Circle	E-4617	300125	Dayton Parts	E-4434B
2692645	Perfect Circle	E-4616	300128	Dayton Parts	E-4435B
2692653	Perfect Circle	E-4640	300140	Dayton Parts	E-4438B
2692663	Perfect Circle	E-5470	300142	Dayton Parts	E-4598B
2692664	Perfect Circle	E-5469	300150	Dayton Parts	E-4434N
2692698	Perfect Circle	E-4629	300155	Dayton Parts	E-4440B
2692700	Perfect Circle	E-5391	300158	Dayton Parts	E-4441B
2692701	Perfect Circle	E-5402	300159	Dayton Parts	E-4441B
2692703	Perfect Circle	E-6847	300163	Dayton Parts	E-4435N
2692704	Perfect Circle	E-6848	300172	Dayton Parts	E-4443N
2692705	Perfect Circle	E-6849	300173	Dayton Parts	E-4443B
2692709	Perfect Circle	E-4642	300174	Dayton Parts	E-4444N
2692710	Perfect Circle	E-4618	300175	Dayton Parts	E-4444B
2692710	Perfect Circle	E-4642	300179	Dayton Parts	E-4445N
2692733	Perfect Circle	E-6694	300180	Dayton Parts	E-4445B
2692736	Perfect Circle	E-6789	300182	Dayton Parts	E-4442B
2692751	Perfect Circle	E-6854	300194	Dayton Parts	E-4448B
2692752	Perfect Circle	E-6855	300195	Dayton Parts	E-4449B
2692753	Perfect Circle	E-6858	300196	Dayton Parts	E-4449B
2692760	Perfect Circle	E-6774	300198	Dayton Parts	E-6453B
2693039	Perfect Circle	E-10137	300204	Dayton Parts	E-4450B
2693040	Perfect Circle	E-10138	300205	Dayton Parts	E-4451B
2695098	Perfect Circle	E-6856	300207	Dayton Parts	E-4452B
2695099	Perfect Circle	E-6857	300209	Dayton Parts	E-4453B
2695100	Perfect Circle	E-6863	300210	Dayton Parts	E-4454B
2695101	Perfect Circle	E-6864	300211	Dayton Parts	E-4454N
2721020	Perfect Circle	E-5310	300214	Dayton Parts	E-6451B
2721036	Perfect Circle	E-5374	300215	Dayton Parts	E-4457B
2721131	Perfect Circle	E-5326	300216	Dayton Parts	E-4458B
2721150	Perfect Circle	E-5325	300217	Dayton Parts	E-4459B
2721174	Perfect Circle	E-6816	300218	Dayton Parts	E-4460B
2721579	Perfect Circle	E-5373	300220	Dayton Parts	E-4461B

INTERCHANGE

Part Number	Supplier	Euclid Number	Part Number	Supplier	Euclid Number
300221	Dayton Parts	E-4462B	310113	Dayton Parts	E-4635
300222	Dayton Parts	E-4462B	310115	Dayton Parts	E-4636
300223	Dayton Parts	E-4463B	310116	Dayton Parts	E-4637
300228	Dayton Parts	E-6450B	310121	Dayton Parts	E-4610
300231	Dayton Parts	E-4467B	310122	Dayton Parts	E-4611
300232	Dayton Parts	E-4468B	310129	Dayton Parts	E-4600
300233	Dayton Parts	E-4469B	310130	Dayton Parts	E-4601
300234	Dayton Parts	E-4470B	310142	Dayton Parts	E-4602
300235	Dayton Parts	E-4471B	310143	Dayton Parts	E-4603
300240	Dayton Parts	E-4595B	310160	Dayton Parts	E-4620
300242	Dayton Parts	E-4694C	310161	Dayton Parts	E-4621
300244	Dayton Parts	E-4695C	310164	Dayton Parts	E-4624
300245	Dayton Parts	E-4599B	310165	Dayton Parts	E-4625
300248	Dayton Parts	E-4697B	310183	Dayton Parts	E-4604
300249	Dayton Parts	E-4693B	310184	Dayton Parts	E-4605
300257	Dayton Parts	E-4696C	310208	Dayton Parts	E-4606
300258	Dayton Parts	E-6869C	310209	Dayton Parts	E-4607
300259	Dayton Parts	E-6454C	310215	Dayton Parts	E-4630
300260	Dayton Parts	E-6195B	310216	Dayton Parts	E-4631
300261	Dayton Parts	E-4459C	310222	Dayton Parts	E-4614
300262	Dayton Parts	E-6196B	310223	Dayton Parts	E-4615
300263	Dayton Parts	E-6197B	310228	Dayton Parts	E-4616
300264	Dayton Parts	E-6868B	310228SF	Dayton Parts	E-9877
300265	Dayton Parts	E-4458C	310229	Dayton Parts	E-4617
300266	Dayton Parts	E-6199C	310229SF	Dayton Parts	E-9878
300267	Dayton Parts	E-6194C	310255	Dayton Parts	E-6665
300268	Dayton Parts	E-6198B	310257	Dayton Parts	E-6720
300269	Dayton Parts	E-6875C	310262	Dayton Parts	E-6403
300274	Dayton Parts	E-4696B	310263	Dayton Parts	E-6404
300276	Dayton Parts	E-9941B	310264	Dayton Parts	E-5392
300277	Dayton Parts	E-9942B	310266	Dayton Parts	E-4622
300279	Dayton Parts	E-6454B	310267	Dayton Parts	E-4623
300284	Dayton Parts	E-6199B	310271	Dayton Parts	E-4612
300285	Dayton Parts	E-6455C	310272	Dayton Parts	E-4613
300286	Dayton Parts	E-9943B	310277	Dayton Parts	E-4609
300287	Dayton Parts	E-10104B	310278	Dayton Parts	E-4608
300288	Dayton Parts	E-10105B	310285	Dayton Parts	E-8757
300289	Dayton Parts	E-10106B	310286	Dayton Parts	E-8758
300292	Dayton Parts	E-9945B	310296	Dayton Parts	E-4640
301SQ47CP1	Mack	E-4467B	310313	Dayton Parts	E-6847
301SQ52	Mack	E-4599B	310314	Dayton Parts	E-6848
303130	Dayton Parts	E-9221	310316	Dayton Parts	E-4629
303136C92	Navistar	E-4441B	310317	Dayton Parts	E-6849
303137C92	Navistar	E-4434B	310322	Dayton Parts	E-4642
303137C92	Navistar	E-4434N	310326	Dayton Parts	E-5391
303138C92	Navistar	E-4449B	310327	Dayton Parts	E-5402
303138R92	Navistar	E-4449B	310338	Dayton Parts	E-6722
303139C92	Navistar	E-4442B	310350	Dayton Parts	E-6135
303140C92	Navistar	E-4454B	310370	Dayton Parts	E-6789
303160	Dayton Parts	E-4572	310380	Dayton Parts	E-5469
303180	Dayton Parts	E-4573	310381	Dayton Parts	E-5470
303200	Dayton Parts	E-4575	310392	Dayton Parts	E-6854
303210	Dayton Parts	E-4576	310393	Dayton Parts	E-6855
303220	Dayton Parts	E-4577	310395	Dayton Parts	E-6856
303240	Dayton Parts	E-4579	310396	Dayton Parts	E-6857
303250	Dayton Parts	E-4580	310397	Dayton Parts	E-4629
303260	Dayton Parts	E-4581	310397	Dayton Parts	E-9880
303270	Dayton Parts	E-4582	310398	Dayton Parts	E-4628
303280	Dayton Parts	E-4583	310398	Dayton Parts	E-9879
3090266	Volvo White GMC	E-10166N	310399	Dayton Parts	E-6858
310-483	Dayton Parts	E-11788	310404	Dayton Parts	E-6774
310-484	Dayton Parts	E-11789	310421	Dayton Parts	E-6863
310112	Dayton Parts	E-4634	310422	Dayton Parts	E-6864

INTERCHANGE

Part Number	Supplier	Euclid Number	Part Number	Supplier	Euclid Number
310424	Dayton Parts	E-4616	370240004	Autocar	E-4614
310424	Dayton Parts	E-4619	370240004	Volvo White GMC	E-4614
310425	Dayton Parts	E-4617	370240005	Autocar	E-4615
310433	Dayton Parts	E-4628	370240005	Volvo White GMC	E-4615
310434	Dayton Parts	E-4629	370245001	Autocar	E-4628
310435	Dayton Parts	E-9881	370245001	Volvo White GMC	E-4628
310441	Dayton Parts	E-9967	370245002	Autocar	E-4629
310443	Dayton Parts	E-10164	370245002	Volvo White GMC	E-4629
310444	Dayton Parts	E-10163	370245010	Volvo White GMC	E-4615
310455	Dayton Parts	E-10137	370245011	Volvo White GMC	E-4614
310456	Dayton Parts	E-10138	370904405	Western Star	E-4471B
310467	Dayton Parts	E-10108	370905005	Volvo White GMC	E-4471B
310468	Dayton Parts	E-10109	3744496	Chrysler	E-4615
310469	Dayton Parts	E-10110	3744497	Chrysler	E-4614
310470	Dayton Parts	E-10111	377635C91	Navistar	E-4630
310471	Dayton Parts	E-9963	377636C91	Navistar	E-4631
310472	Dayton Parts	E-9962	37QC34A	Mack	E-10114
310473	Dayton Parts	E-9965	3838004	Chrysler	E-4637
310474	Dayton Parts	E-9966	3838005	Chrysler	E-4636
310475	Dayton Parts	E-10112	384460B	Trailmobile	E-4460B
310476	Dayton Parts	E-10113	384608	Trailmobile	E-4608
3130711	Volvo White GMC	E-10165N	384614	Trailmobile	E-4614
346-446	Dayton Parts	E-11790	384615	Trailmobile	E-4615
346142	Dayton Parts	E-5310	384616	Trailmobile	E-4616
346188	Dayton Parts	E-6816	384622	Trailmobile	E-4622
346189	Dayton Parts	E-5325	384623	Trailmobile	E-4623
346190	Dayton Parts	E-5326	384693B	Trailmobile	E-4693B
346218	Dayton Parts	E-5338	384696C	Trailmobile	E-4696C
346219	Dayton Parts	E-5339	385325	Trailmobile	E-5325
346223	Dayton Parts	E-5342	3853990	GMC	E-4444B
346249	Dayton Parts	E-5366	3854744	GMC	E-4430B
346256	Dayton Parts	E-5372	3864347	GMC	E-4620
346257	Dayton Parts	E-5373	3864348	GMC	E-4621
346258	Dayton Parts	E-5374	3864353	GMC	E-4624
346262	Dayton Parts	E-5378	3864354	GMC	E-4625
346263	Dayton Parts	E-5379	389050001	Volvo White GMC	E-6806
346264	Dayton Parts	E-5380	3892946	GMC	E-5392
346279	Dayton Parts	E-5386	3948867	Volvo White GMC	E-4610
346282	Dayton Parts	E-6804	3948868	Volvo White GMC	E-4611
346286	Dayton Parts	E-6806	399942C93	Navistar	E-4451B
346293	Dayton Parts	E-5390	4026831	Chrysler	E-6665
346297	Dayton Parts	E-6808	408547C91	Navistar	E-4448B
346300	Dayton Parts	E-6878	408547C93	Navistar	E-4448B
346310	Dayton Parts	E-6815	4186007	Chrysler	E-6678
346339	Dayton Parts	E-6817	438368C91	Navistar	E-4614
346341	Dayton Parts	E-6827	438369C91	Navistar	E-4615
346345	Dayton Parts	E-6835	4384167	Chrysler	E-6774
346350	Dayton Parts	E-6833	442354C91	Navistar	E-4629
346351	Dayton Parts	E-6834	442354C92	Navistar	E-4629
346367	Dayton Parts	E-6694	447094C91	Navistar	E-4630
346370	Dayton Parts	E-6818	447095C91	Navistar	E-4631
346371	Dayton Parts	E-6819	450062C91	Navistar	E-4605
346377	Dayton Parts	E-6825	450063C91	Navistar	E-4604
346379	Dayton Parts	E-6836	452344C91	Navistar	E-4450B
346383	Dayton Parts	E-6839	453831C91	Navistar	E-6808
346384	Dayton Parts	E-9911	458480	GMC	E-6720
346385	Dayton Parts	E-11463	459307C91	Navistar	E-4613
346390	Dayton Parts	E-9931	461665C91	Navistar	E-4618
346406	Dayton Parts	E-9926	462389	GMC	E-4612
362297	GMC	E-6404	462390	GMC	E-4613
362298	GMC	E-6403	472094C91	Navistar	E-4462B
3634206	Chrysler	E-4617	473695C92	Navistar	E-4460B
3634207	Chrysler	E-4616	474520C91	Navistar	E-4458B

INTERCHANGE

Part Number	Supplier	Euclid Number	Part Number	Supplier	Euclid Number
474520C91	Navistar	E-4458C	8386B	Moog	E-4434B
480645C92	Navistar	E-5366	8386N	Moog	E-4434N
486354C91	Navistar	E-4628	839307B	Volvo White GMC	E-4617
486355C91	Navistar	E-4629	8462B	Moog	E-4435B
486355C91F	Navistar	E-4629	8462N	Moog	E-4435N
486355R91	Navistar	E-4629	8488B	Moog	E-4440B
486806C93	Navistar	E-4697B	8489B	Moog	E-4442B
486807C91	Navistar	E-6849	8490T	Moog	E-4430B
489023C91	Navistar	E-5390	8491B	Moog	E-4443B
490425C91	Navistar	E-6878	8491N	Moog	E-4443N
491665C91	Navistar	E-4618	8492B	Moog	E-4444B
491666C91	Navistar	E-4642	8492N	Moog	E-4444N
493092C92	Navistar	E-4461B	8500B	Moog	E-4445B
493094C94	Navistar	E-4462B	8500N	Moog	E-4445N
493095C91	Navistar	E-4463B	8507B	Moog	E-4438B
493095C92	Navistar	E-4461B	8507N	Moog	E-4438N
493095C93	Navistar	E-4463B	8514B	Moog	E-4449B
493652C91	Navistar	E-6804	8514N	Moog	E-4449B
503523C91	Navistar	E-5386	8515	Moog	E-4442B
506661C91	Navistar	E-5469	8515B	Moog	E-4442B
506662C91	Navistar	E-5470	8517B	Moog	E-4448B
506684C91	Navistar	E-4629	8518B	Moog	E-4454B
507835C91	Navistar	E-4630	8518N	Moog	E-4454N
507836C91	Navistar	E-4631	8519B	Moog	E-4441B
507837C91	Navistar	E-4614	8519N	Moog	E-4441B
507838C91	Navistar	E-4615	8527B	Moog	E-4598B
549800C91	Navistar	E-4468B	8551B	Moog	E-6453B
577682C91	Navistar	E-6847	8553B	Moog	E-4450B
577683C91	Navistar	E-6848	8567B	Moog	E-4451B
577684C91	Navistar	E-4595B	8568B	Moog	E-4452B
581063C91	Navistar	E-4629	8570B	Moog	E-4453B
586806C91	Navistar	E-4697B	8571B	Moog	E-4458B
586806C92	Navistar	E-4697B	8571C	Moog	E-4458C
586806C93	Navistar	E-4697B	8572B	Moog	E-4459B
588808C91	Navistar	E-4693B	8572C	Moog	E-4459C
590583C91	Navistar	E-4628	8573B	Moog	E-4457B
590584C91	Navistar	E-4629	8574B	Moog	E-6451B
591945C92	Navistar	E-4448B	8577B	Moog	E-4460B
592872C91	Navistar	E-6858	8579B	Moog	E-4461B
597258C91	Navistar	E-4458C	8581B	Moog	E-4462B
597556C91	Navistar	E-4694C	8581N	Moog	E-4462B
61556R91	Navistar	E-4431B	8583B	Moog	E-4463B
669335	GMC	E-5326	8583N	Moog	E-4463B
671488	GMC	E-4606	8589B	Moog	E-6450B
671489	GMC	E-4607	8590B	Moog	E-4468B
684196	GMC	E-5374	8601B	Moog	E-4467B
698571	GMC	E-4614	8603B	Moog	E-4469B
698572	GMC	E-4615	8605B	Moog	E-4471B
718796	GMC	E-5372	8607B	Moog	E-4470B
718798	GMC	E-5373	8610B	Moog	E-4697B
798203	GMC	E-4629	8611B	Moog	E-6868B
798204	GMC	E-4628	8611C	Moog	E-4695C
806355	Eaton	E-4696C	8612B	Moog	E-4595B
806356	Eaton	E-6869C	8613B	Moog	E-4469B
817018	Eaton	E-10138	8616C	Moog	E-4694C
817019	Eaton	E-10137	8617B	Moog	E-4693B
820626	Eaton	E-4628	8618C	Moog	E-4696C
820627	Eaton	E-4629	8627C	Moog	E-6454C
820694	Eaton	E-4628	8631C	Moog	E-6869C
820695	Eaton	E-4629	8633C	Moog	E-6194C
8336B	Moog	E-6865B	8635C	Moog	E-4695C
8375B	Moog	E-4431B	8637B	Moog	E-6198B
838308B	Volvo White GMC	E-4616	8639B	Moog	E-6195B

INTERCHANGE

Part Number	Supplier	Euclid Number	Part Number	Supplier	Euclid Number
8641B	Moog	E-6197B	A3144Q225	Kenworth	E-4610
8643B	Moog	E-6196B	A3144Q225	Marmon	E-4610
8645B	Moog	E-4448B	A3144Q225	Peterbilt	E-4610
872469	Autocar	E-4611	A3144Q225	Volvo White GMC	E-4610
872470	Autocar	E-4610	A3144R226	Freightliner	E-4611
887783A	Autocar	E-4616	A3144R226	Kenworth	E-4611
887784A	Autocar	E-4617	A3144R226	Marmon	E-4611
8885021	GMC	E-4469B	A3144R226	Peterbilt	E-4611
8885621	GMC	E-4469B	A3144R226	Volvo White GMC	E-4611
8885856	GMC	E-4469B	A3144U438	Mack	E-4628
8885857	GMC	E-4443B	A3144U438	Volvo White GMC	E-4628
8885857	GMC	E-4443N	A3144V437	Volvo White GMC	E-4629
894049R93	Navistar	E-6847	AKP3490	PAI	E-4467B
894050R93	Navistar	E-6848	AKP9819	PAI	E-4599B
894144R91	Navistar	E-4634	AKP9821	PAI	E-4454N
894145R91	Navistar	E-4635	AKP9822	PAI	E-4468B
969055R91	Navistar	E-4616	AKP9823	PAI	E-4458B
969056R91	Navistar	E-4617	ARE9950	PAI	E-4616
A23144M273	Kenworth	E-6847	ARE9955	PAI	E-4611
A23144M273	Marmon	E-6847	ARE9984	PAI	E-4610
A23144N274	Kenworth	E-6848	ARE9985	PAI	E-4640
A23144N274	Marmon	E-6848	ARE9986	PAI	E-4629
A3144C237	Freightliner	E-4618	ARE9987	PAI	E-4628
A3144C237	Kenworth	E-4618	ARE9988	PAI	E-4615
A3144C237	Marmon	E-4618	ARE9989	PAI	E-4614
A3144C237	Peterbilt	E-4618	ARE9990	PAI	E-4617
A3144C237	Volvo White GMC	E-4618	ARE9991	PAI	E-4617
A3144D238	Freightliner	E-4619	B7TZ3111F	Ford	E-4438B
A3144D238	Kenworth	E-4619	B8TZ3A130B	Ford	E-4619
A3144D238	Marmon	E-4619	B8TZ3A131B	Ford	E-4618
A3144D238	Peterbilt	E-4619	C1TZ3A130A	Ford	E-4635
A3144D238	Volvo White GMC	E-4619	C1TZ3A130B	Ford	E-4603
A3144D524	Freightliner	E-4615	C1TZ3A131A	Ford	E-4636
A3144D524	Kenworth	E-4615	C1TZ3A131B	Ford	E-4602
A3144D524	Mack	E-4615	C1TZ3A131C	Ford	E-4610
A3144D524	Marmon	E-4615	C2TZ3111F	Ford	E-4438N
A3144D524	Peterbilt	E-4615	C2TZ3111G	Ford	E-4441B
A3144D524	Volvo White GMC	E-4615	C3TZ3111A	Ford	E-4440B
A3144E525	Freightliner	E-4614	C4TZ3111C	Ford	E-4449B
A3144E525	Kenworth	E-4614	C7TZ3304A	Ford	E-5310
A3144E525	Mack	E-4614	C7TZ3A130D	Ford	E-4605
A3144E525	Marmon	E-4614	C7TZ3A131D	Ford	E-4604
A3144E525	Peterbilt	E-4614	C8TZ3A130A	Ford	E-4611
A3144E525	Volvo White GMC	E-4614	D0HZ3111C	Ford	E-4449B
A3144F448	Freightliner	E-4629	D0HZ3281A	Ford	E-9957
A3144G449	Freightliner	E-4628	D0HZ3304B	Ford	E-5342
A3144J296	Freightliner	E-4616	D0HZ3A130A	Ford	E-4615
A3144J296	Kenworth	E-4617	D0HZ3A131A	Ford	E-4614
A3144J296	Marmon	E-4617	D0HZ3B711A	Ford	E-9967
A3144J296	Peterbilt	E-4617	D1HZ3111A	Ford	E-4441B
A3144J296	Volvo White GMC	E-4617	D1HZ3111B	Ford	E-4442B
A3144K297	Freightliner	E-4617	D2TZ3111D	Ford	E-4440B
A3144K297	Kenworth	E-4616	D4HZ3281A	Ford	E-9958
A3144K297	Marmon	E-4616	D5HZ3304D	Ford	E-5325
A3144K297	Peterbilt	E-4616	D5TZ3A130A	Ford	E-4622
A3144K297	Volvo White GMC	E-4616	D5TZ3A131A	Ford	E-4623
A3144M533	Freightliner	E-6847	D5UZ3111A	Ford	E-6453B
A3144M533	Kenworth	E-6847	D5UZ3111B	Ford	E-6451B
A3144M533	Marmon	E-6847	D6HZ3111A	Ford	E-4459B
A3144N534	Freightliner	E-6848	D6HZ3111B	Ford	E-4457B
A3144N534	Kenworth	E-6848	D6HZ3111C	Ford	E-4459C
A3144N534	Marmon	E-6848	D6TZ3111A	Ford	E-4452B
A3144Q225	Freightliner	E-4610	DL1020	Unimotive	E-5386

INTERCHANGE

Part Number	Supplier	Euclid Number	Part Number	Supplier	Euclid Number
DL1034	Unimotive	E-5390	DS1203	Moog	E-6835
DL2345	Eaton	E-5378	DS1203	TRW	E-6835
DL2346	Eaton	E-5379	DS1204	Flagg	E-6836
DL2347	Eaton	E-5380	DS1204	Moog	E-6836
DL2351	Eaton	E-5386	DS1204	TRW	E-6836
DL2360	Eaton	E-5366	DS1207	Flagg	E-6839
DL2449	Eaton	E-5372	DS1207	Moog	E-6839
DL2450	Eaton	E-5373	DS1207	TRW	E-6839
DL2451	Eaton	E-5342	DS1214	Flagg	E-9911
DL2452	Eaton	E-5325	DS1214	Moog	E-9911
DL800	Unimotive	E-5310	DS1214	TRW	E-9911
DL908	Unimotive	E-5325	DS1215	Flagg	E-11463
DL910	Unimotive	E-5326	DS1215	TRW	E-11463
DL948	Unimotive	E-5338	DS1218	Flagg	E-9897
DL949	Unimotive	E-5339	DS1218	Moog	E-9897
DL953	Unimotive	E-5342	DS1218	TRW	E-9897
DL979	Unimotive	E-5366	DS1234	TRW	E-9931
DL986	Unimotive	E-5372	DS1261	TRW	E-9961
DL987	Unimotive	E-5373	DS1265	TRW	E-9925
DL988	Unimotive	E-5374	DS1266	Flagg	E-9926
DL992	Unimotive	E-5378	DS1266	TRW	E-9926
DL993	Unimotive	E-5379	DS1268	TRW	E-9927
DL994	Unimotive	E-5380	DS1269	TRW	E-9929
DS1020	Flagg	E-5386	DS1270	TRW	E-9933
DS1020	McQuay	E-5386	DS1271	TRW	E-9934
DS1020	Moog	E-5386	DS1362S	Flagg	E-9960
DS1020	TRW	E-5386	DS1362S	TRW	E-9960
DS1022	TRW	E-6804	DS1366	TRW	E-9937
DS1024	TRW	E-6806	DS1367A	TRW	E-9959
DS1028	Flagg	E-6808	DS1368A	TRW	E-9964
DS1028	Moog	E-6808	DS1369	TRW	E-9936
DS1028	TRW	E-6808	DS1379S	TRW	E-9957
DS1031	TRW	E-6878	DS1380S	TRW	E-9958
DS1034	Flagg	E-5390	DS1442	TRW	E-11790
DS1034	McQuay	E-5390	DS800	Flagg	E-5310
DS1034	Moog	E-5390	DS800	McQuay	E-5310
DS1034	TRW	E-5390	DS800	Moog	E-5310
DS1044	Flagg	E-6815	DS800	TRW	E-5310
DS1044	Moog	E-6815	DS907	McQuay	E-6816
DS1044	TRW	E-6815	DS907	Moog	E-6816
DS1064	Flagg	E-6816	DS907	TRW	E-6816
DS1064	McQuay	E-6816	DS908	Flagg	E-5325
DS1064	Moog	E-6816	DS908	McQuay	E-5325
DS1064	TRW	E-6816	DS908	Moog	E-5325
DS1067	Flagg	E-6817	DS908	TRW	E-5325
DS1067	TRW	E-6817	DS910	Flagg	E-5326
DS1179	Flagg	E-6818	DS910	McQuay	E-5326
DS1179	Moog	E-6818	DS910	Moog	E-5326
DS1179	TRW	E-6818	DS910	TRW	E-5326
DS1180	Flagg	E-6819	DS948	Flagg	E-5338
DS1180	Moog	E-6819	DS948	McQuay	E-5338
DS1180	TRW	E-6819	DS948	Moog	E-5338
DS1186	TRW	E-6825	DS948	TRW	E-5338
DS1191	Flagg	E-6827	DS949	Flagg	E-5339
DS1191	Moog	E-6827	DS949	McQuay	E-5339
DS1191	TRW	E-6827	DS949	Moog	E-5339
DS1199	Flagg	E-6833	DS949	TRW	E-5339
DS1199	Moog	E-6833	DS953	Flagg	E-5342
DS1199	TRW	E-6833	DS953	McQuay	E-5342
DS1200	Flagg	E-6834	DS953	Moog	E-5342
DS1200	Moog	E-6834	DS953	TRW	E-5342
DS1200	TRW	E-6834	DS979	Flagg	E-5366
DS1203	Flagg	E-6835	DS979	McQuay	E-5366

INTERCHANGE

Part Number	Supplier	Euclid Number	Part Number	Supplier	Euclid Number
DS979	Moog	E-5366	ES150R	Moog	E-4635
DS979	TRW	E-5366	ES150R	O & S Mfg.	E-4635
DS986	Flagg	E-5372	ES150R	TRW	E-4635
DS986	McQuay	E-5372	ES176L	Flagg	E-4636
DS986	Moog	E-5372	ES176L	McQuay	E-4636
DS986	TRW	E-5372	ES176L	Moog	E-4636
DS987	Flagg	E-5373	ES176L	O & S Mfg.	E-4636
DS987	McQuay	E-5373	ES176L	TRW	E-4636
DS987	Moog	E-5373	ES176R	Flagg	E-4637
DS987	TRW	E-5373	ES176R	McQuay	E-4637
DS988	Flagg	E-5374	ES176R	Moog	E-4637
DS988	McQuay	E-5374	ES176R	O & S Mfg.	E-4637
DS988	Moog	E-5374	ES176R	TRW	E-4637
DS988	TRW	E-5374	ES187L	Flagg	E-4610
DS992	Flagg	E-5378	ES187L	McQuay	E-4610
DS992	McQuay	E-5378	ES187L	Moog	E-4610
DS992	Moog	E-5378	ES187L	O & S Mfg.	E-4610
DS992	TRW	E-5378	ES187L	TRW	E-4610
DS993	Flagg	E-5379	ES187R	Flagg	E-4611
DS993	McQuay	E-5379	ES187R	McQuay	E-4611
DS993	Moog	E-5379	ES187R	Moog	E-4611
DS993	TRW	E-5379	ES187R	O & S Mfg.	E-4611
DS994	Flagg	E-5380	ES187R	TRW	E-4611
DS994	McQuay	E-5380	ES2010L	Flagg	E-6665
DS994	Moog	E-5380	ES2010L	McQuay	E-6665
DS994	TRW	E-5380	ES2010L	Moog	E-6665
E0HZ3304A	Ford	E-5338	ES2010L	TRW	E-6665
E0HZ3304B	Ford	E-5339	ES2011R	Flagg	E-6720
E0HZ3304D	Ford	E-5339	ES2011R	McQuay	E-6720
E0TZ3111A	Ford	E-6450B	ES2011R	Moog	E-6720
E15142	O & S Mfg.	E-10114	ES2011R	TRW	E-6720
E2HT3304AA	Ford	E-5339	ES2026R	Flagg	E-6403
E3HZ3304A	Ford	E-6836	ES2026R	McQuay	E-6403
E3HZ3304B	Ford	E-5339	ES2026R	Moog	E-6403
E3HZ3304H	Ford	E-5325	ES2026R	TRW	E-6403
E3HZ3304J	Ford	E-5342	ES2027L	Flagg	E-6404
E3HZ3A130A	Ford	E-4615	ES2027L	McQuay	E-6404
E3HZ3A131A	Ford	E-4614	ES2027L	Moog	E-6404
E4HZ3208B	Ford	E-9959	ES2027L	TRW	E-6404
E4HZ3304B	Ford	E-5325	ES2030R	Flagg	E-5392
E4HZ3A130A	Ford	E-4615	ES2030R	McQuay	E-5392
E4HZ3A130B	Ford	E-4615	ES2030R	Moog	E-5392
E4HZ3A131A	Ford	E-4614	ES2030R	TRW	E-5392
E6HZ3A130A	Ford	E-4623	ES2035L	Flagg	E-4622
E6HZ3A131A	Ford	E-4622	ES2035L	McQuay	E-4622
E8HZ3111A	Ford	E-6195B	ES2035L	Moog	E-4622
E8HZ3304B	Ford	E-6827	ES2035L	O & S Mfg.	E-4622
E8HZ3304E	Ford	E-6835	ES2035L	TRW	E-4622
E8HZ3304F	Ford	E-6835	ES2036R	Flagg	E-4623
E8HZ3304H	Ford	E-5325	ES2036R	McQuay	E-4623
E8HZ3A130A	Ford	E-4605	ES2036R	Moog	E-4623
E8HZ3A131A	Ford	E-4604	ES2036R	O & S Mfg.	E-4623
E8TZ3304A	Ford	E-6694	ES2036R	TRW	E-4623
E9HZ3111A	Ford	E-6196B	ES2040R	McQuay	E-4617
E9HZ3111B	Ford	E-6197B	ES2040R	Moog	E-4617
E9HZ3111C	Ford	E-9943B	ES2040R	O & S Mfg.	E-4617
ES150L	Flagg	E-4634	ES2040R	TRW	E-4617
ES150L	McQuay	E-4634	ES2041L	McQuay	E-4616
ES150L	Moog	E-4634	ES2041L	Moog	E-4616
ES150L	O & S Mfg.	E-4634	ES2041L	O & S Mfg.	E-4616
ES150L	TRW	E-4634	ES2041L	TRW	E-4616
ES150R	Flagg	E-4635	ES2061L	Flagg	E-4612
ES150R	McQuay	E-4635	ES2061L	McQuay	E-4612

INTERCHANGE

Part Number	Supplier	Euclid Number	Part Number	Supplier	Euclid Number
ES2061L	Moog	E-4612	ES2204R	TRW	E-4629
ES2061L	O & S Mfg.	E-4612	ES2207R	McQuay	E-4618
ES2061L	TRW	E-4612	ES2207R	Moog	E-4618
ES2062R	Flagg	E-4613	ES2207R	O & S Mfg.	E-4618
ES2062R	McQuay	E-4613	ES2207R	TRW	E-4618
ES2062R	Moog	E-4613	ES2208R	McQuay	E-4642
ES2062R	O & S Mfg.	E-4613	ES2208R	Moog	E-4642
ES2062R	TRW	E-4613	ES2208R	O & S Mfg.	E-4642
ES2063R	McQuay	E-4623	ES2208R	TRW	E-4642
ES2069R	Flagg	E-4609	ES2209R	McQuay	E-4629
ES2069R	McQuay	E-4609	ES2209R	Moog	E-4629
ES2069R	Moog	E-4609	ES2209R	TRW	E-4629
ES2069R	O & S Mfg.	E-4609	ES2210L	McQuay	E-4628
ES2069R	TRW	E-4609	ES2210L	Moog	E-4628
ES2070L	Flagg	E-4608	ES2210L	TRW	E-4628
ES2070L	McQuay	E-4608	ES2224L	Flagg	E-5391
ES2070L	Moog	E-4608	ES2224L	McQuay	E-5391
ES2070L	O & S Mfg.	E-4608	ES2224L	Moog	E-5391
ES2070L	TRW	E-4608	ES2224L	TRW	E-5391
ES2090L	Flagg	E-4628	ES2225R	Flagg	E-5402
ES2090L	McQuay	E-4628	ES2225R	Moog	E-5402
ES2090L	Moog	E-4628	ES2225R	TRW	E-5402
ES2090L	O & S Mfg.	E-4628	ES2234R	Flagg	E-6722
ES2090L	TRW	E-4628	ES2234R	Moog	E-6722
ES2090L	TRW	E-4629	ES2234R	TRW	E-6722
ES2091R	Flagg	E-4629	ES235L	Flagg	E-4600
ES2091R	McQuay	E-4629	ES235L	McQuay	E-4600
ES2091R	Moog	E-4629	ES235L	Moog	E-4600
ES2091R	O & S Mfg.	E-4629	ES235L	O & S Mfg.	E-4600
ES2091R	TRW	E-4628	ES235NL	Flagg	E-4600
ES2091R	TRW	E-4629	ES235NL	McQuay	E-4600
ES2113R	McQuay	E-4617	ES235NL	Moog	E-4600
ES2113R	Moog	E-4617	ES235NR	McQuay	E-4601
ES2113R	TRW	E-4617	ES235NR	Moog	E-4601
ES2114R	Flagg	E-4617	ES235R	Flagg	E-4601
ES2114R	McQuay	E-4617	ES235R	McQuay	E-4601
ES2114R	Moog	E-4617	ES235R	Moog	E-4601
ES2114R	TRW	E-4617	ES235R	O & S Mfg.	E-4601
ES2115R	McQuay	E-4617	ES258L	TRW	E-6774
ES2115R	Moog	E-4617	ES2613L	Flagg	E-5469
ES2115R	TRW	E-4617	ES2613L	TRW	E-5469
ES2116L	Flagg	E-4616	ES2614R	Flagg	E-5470
ES2116L	McQuay	E-4616	ES2614R	TRW	E-5470
ES2116L	Moog	E-4616	ES2847R	Moog	E-6774
ES2116L	TRW	E-4616	ES2847R	TRW	E-6774
ES2118L	Flagg	E-4640	ES2914R	Moog	E-6789
ES2118L	McQuay	E-4640	ES2914R	TRW	E-6789
ES2118L	Moog	E-4640	ES2925L	TRW	E-6694
ES2118L	O & S Mfg.	E-4640	ES3026L	Flagg	E-6854
ES2118L	TRW	E-4640	ES3026L	TRW	E-6854
ES2147R	McQuay	E-6678	ES3027R	Flagg	E-6855
ES2147R	TRW	E-6678	ES3027R	TRW	E-6855
ES2147RL	Moog	E-6678	ES3030R	Flagg	E-6856
ES2200L	TRW	E-6847	ES3030R	Moog	E-6856
ES2201R	TRW	E-6848	ES3030R	TRW	E-6856
ES2202R	Flagg	E-4629	ES3031L	Flagg	E-6857
ES2202R	McQuay	E-4629	ES3031L	Moog	E-6857
ES2202R	Moog	E-4629	ES3031L	TRW	E-6857
ES2202R	TRW	E-4629	ES3032R	Flagg	E-6858
ES2203R	Flagg	E-6849	ES3032R	Moog	E-6858
ES2203R	TRW	E-6849	ES3032R	TRW	E-6858
ES2204R	McQuay	E-4629	ES3033L	TRW	E-4629
ES2204R	Moog	E-4629	ES3033L	TRW	E-9880

INTERCHANGE

Part Number	Supplier	Euclid Number	Part Number	Supplier	Euclid Number
ES3034R	TRW	E-4628	ES332R	TRW	E-4625
ES3034R	TRW	E-9879	ES3442R	TRW	E-11788
ES3035L	TRW	E-4622	ES3443L	TRW	E-11789
ES3036R	TRW	E-4623	ES346L	Flagg	E-4618
ES3037R	TRW	E-4613	ES346L	McQuay	E-4618
ES3038L	TRW	E-4612	ES346L	Moog	E-4618
ES3039L	TRW	E-6863	ES346L	O & S Mfg.	E-4618
ES3040R	TRW	E-6864	ES346L	TRW	E-4618
ES304L	Flagg	E-4602	ES346R	Flagg	E-4619
ES304L	McQuay	E-4602	ES346R	McQuay	E-4619
ES304L	Moog	E-4602	ES346R	Moog	E-4619
ES304L	O & S Mfg.	E-4602	ES346R	O & S Mfg.	E-4619
ES304L	TRW	E-4602	ES346R	TRW	E-4619
ES304R	Flagg	E-4603	ES3476	TRW	E-10137
ES304R	McQuay	E-4603	ES3477	TRW	E-10138
ES304R	Moog	E-4603	ES373L	Flagg	E-4604
ES304R	O & S Mfg.	E-4603	ES373L	McQuay	E-4604
ES304R	TRW	E-4603	ES373L	Moog	E-4604
ES3057	TRW	E-4616	ES373L	O & S Mfg.	E-4604
ES3086L	TRW	E-6135	ES373L	TRW	E-4604
ES3087R	TRW	E-6136	ES373R	Flagg	E-4605
ES3176R	TRW	E-9963	ES373R	McQuay	E-4605
ES3177L	TRW	E-9962	ES373R	Moog	E-4605
ES3214R	TRW	E-9948	ES373R	O & S Mfg.	E-4605
ES3217L	TRW	E-4614	ES373R	TRW	E-4605
ES3218R	TRW	E-4615	ES376L	Flagg	E-4616
ES3219L	TRW	E-9951	ES376L	McQuay	E-4616
ES3220R	TRW	E-9952	ES376L	Moog	E-4616
ES3252R	TRW	E-9881	ES376L	O & S Mfg.	E-4616
ES3268L	TRW	E-10112	ES376L	TRW	E-4616
ES3269R	TRW	E-10113	ES376R	Flagg	E-4617
ES3270L	TRW	E-10110	ES376R	McQuay	E-4617
ES3271R	TRW	E-10111	ES376R	Moog	E-4617
ES3274L	TRW	E-10108	ES376R	O & S Mfg.	E-4617
ES3275R	TRW	E-10109	ES376R	TRW	E-4617
ES3283R	Flagg	E-9966	ES405L	Flagg	E-4606
ES3283R	TRW	E-9966	ES405L	McQuay	E-4606
ES3284L	Flagg	E-9965	ES405L	Moog	E-4606
ES3284L	TRW	E-9965	ES405L	O & S Mfg.	E-4606
ES3297R	Flagg	E-8758	ES405L	TRW	E-4606
ES3297R	TRW	E-8758	ES405R	Flagg	E-4607
ES3298L	Flagg	E-8757	ES405R	McQuay	E-4607
ES3298L	TRW	E-8757	ES405R	Moog	E-4607
ES3304R	TRW	E-9967	ES405R	O & S Mfg.	E-4607
ES330L	Flagg	E-4620	ES405R	TRW	E-4607
ES330L	McQuay	E-4620	ES411L	Flagg	E-4630
ES330L	Moog	E-4620	ES411L	McQuay	E-4630
ES330L	O & S Mfg.	E-4620	ES411L	Moog	E-4630
ES330L	TRW	E-4620	ES411L	O & S Mfg.	E-4630
ES330R	Flagg	E-4621	ES411L	TRW	E-4630
ES330R	McQuay	E-4621	ES411R	Flagg	E-4631
ES330R	Moog	E-4621	ES411R	McQuay	E-4631
ES330R	O & S Mfg.	E-4621	ES411R	Moog	E-4631
ES330R	TRW	E-4621	ES411R	O & S Mfg.	E-4631
ES332L	Flagg	E-4624	ES411R	TRW	E-4631
ES332L	McQuay	E-4624	ES423L	Flagg	E-4614
ES332L	Moog	E-4624	ES423L	McQuay	E-4614
ES332L	O & S Mfg.	E-4624	ES423L	Moog	E-4614
ES332L	TRW	E-4624	ES423L	O & S Mfg.	E-4614
ES332R	Flagg	E-4625	ES423L	TRW	E-4614
ES332R	McQuay	E-4625	ES423R	Flagg	E-4615
ES332R	Moog	E-4625	ES423R	McQuay	E-4615
ES332R	O & S Mfg.	E-4625	ES423R	Moog	E-4615

INTERCHANGE

Part Number	Supplier	Euclid Number	Part Number	Supplier	Euclid Number
ES423R	O & S Mfg.	E-4615	FAK4472	Navistar	E-4445B
ES423R	TRW	E-4615	FAK4477	Navistar	E-4448B
ES431L	Flagg	E-4617	FAK4479	Navistar	E-6453B
ES431L	TRW	E-4616	FAK4485	Navistar	E-4451B
ES431R	Flagg	E-4616	FAK4487	Navistar	E-4452B
ES431R	McQuay	E-4616	FAK4489	Navistar	E-4453B
ES431R	Moog	E-4616	FAK4492	Navistar	E-6451B
ES431R	O & S Mfg.	E-4616	FAK4493	Navistar	E-4457B
ES431R	TRW	E-4617	FAK4494	Navistar	E-4459B
ES434L	Flagg	E-5391	FAK4495	Navistar	E-4460B
ES434L	McQuay	E-5391	FAK4497	Navistar	E-4461B
ES434L	Moog	E-5391	FAK4498	Navistar	E-4462B
ES434L	TRW	E-5391	FAK4500	Navistar	E-4463B
ES6001T	McQuay	E-6722	FAK4505	Navistar	E-6450B
ES9000	Flagg	E-9967	FAK4508	Navistar	E-4467B
ES9000	O & S Mfg.	E-9967	FAK4509	Navistar	E-4469B
ES9001L	Flagg	E-10138	FAK4510	Navistar	E-4470B
ES9001R	Flagg	E-10137	FAK4511	Navistar	E-4471B
ES9009	Flagg	E-8757	FAK4514	Navistar	E-4599B
ES9010	Flagg	E-8758	FAK4516	Navistar	E-4697B
F0HZ3281B	Ford	E-9960	FAK4517	Navistar	E-4693B
F0HZ3304A	Ford	E-6836	FAK4518	Navistar	E-4462B
F0HZ3304E	Ford	E-6839	FAK4524	Navistar	E-4696C
F0HZ3304F	Ford	E-6839	FAK4527	Navistar	E-4434N
F0HZ3304G	Ford	E-6827	FAK4530	Navistar	E-5441B
F0HZ3A130D	Ford	E-6863	FAK4531	Navistar	E-4441B
F0HZ3A131B	Ford	E-4622	FAK4532	Navistar	E-4438B
F0HZ3A131B	Ford	E-4623	FAK4533	Navistar	E-4434B
F0HZ3A131D	Ford	E-6864	FAK4536	Navistar	E-4441B
F1HZ3111A	Ford	E-6195B	FAK4537	Navistar	E-4438N
F1HZ3280C	Ford	E-9961	FAK4538	Navistar	E-4449B
F1HZ3304A	Ford	E-9925	FAK4539	Navistar	E-4449B
F1HZ3304C	Ford	E-9926	FAK4541	Navistar	E-4454N
F1HZ3304D	Ford	E-9926	FAK4542	Navistar	E-4454B
F1HZ3304E	Ford	E-9927	FAK4544	Navistar	E-4442B
F1HZ3304J	Ford	E-9929	FAK4548	Navistar	E-4441B
F1HZ3304L	Ford	E-9931	FAK4549	Navistar	E-4434B
F1HZ3A130A	Ford	E-9962	FAK4549	Navistar	E-4434N
F1HZ3A130B	Ford	E-9963	FAK4550	Navistar	E-4449B
F2HZ3304C	Ford	E-9933	FAK4551	Navistar	E-4442B
F2HZ3304D	Ford	E-9934	FAK4553	Navistar	E-4450B
F3HZ3A130B	Ford	E-9962	FAK4555	Navistar	E-4468B
F3HZ3A131B	Ford	E-9963	FAK4558	Navistar	E-4458B
F4HZ3304A	Ford	E-9936	FAK4559	Navistar	E-4450B
F5HZ3111A	Ford	E-9945B	FAK4560	Navistar	E-4595B
F5HZ3280A	Ford	E-9964	FAK4564	Navistar	E-4694C
F5HZ3304A	Ford	E-9937	FAK4566	Navistar	E-4695C
F5HZ3A130B	Ford	E-9965	FAK4567	Navistar	E-6868B
F5HZ3A131B	Ford	E-9966	FAK4568	Navistar	E-4458C
F6HZ3304FB	Ford	E-11790	FAK4570	Navistar	E-6199C
F6HZ3A130AA	Ford	E-11788	FAK4571	Navistar	E-4454B
F6HZ3A131AA	Ford	E-11789	FAK4572	Navistar	E-4696B
FAK4444	Navistar	E-4430B	FAK4574	Navistar	E-6194C
FAK4446	Navistar	E-4431B	FAK4582	Navistar	E-6198B
FAK4454	Navistar	E-4435B	FAK4586	Navistar	E-6195B
FAK4460	Navistar	E-4598B	FAK4587	Navistar	E-6196B
FAK4461	Navistar	E-4440B	FAK4589	Navistar	E-6197B
FAK4465	Navistar	E-4435N	FAK5444	Navistar	E-4460B
FAK4467	Navistar	E-4443N	FAK5445	Navistar	E-4462B
FAK4468	Navistar	E-4443B	FAK5447	Navistar	E-4463B
FAK4469	Navistar	E-4444N	FAK5451	Navistar	E-4697B
FAK4470	Navistar	E-4444B	FAK5452	Navistar	E-4460B
FAK4471	Navistar	E-4445N	FAK5453	Navistar	E-6875C

INTERCHANGE

Part Number	Supplier	Euclid Number	Part Number	Supplier	Euclid Number
FAK5454	Navistar	E-6198B	FKP123B	Flagg	E-10106B
FAK5455	Navistar	E-9941B	FKP124B	Flagg	E-9945B
FAK5456	Navistar	E-9942B	FKP27B	Flagg	E-4435B
FAK8453	Navistar	E-4572	FKP27N	Flagg	E-4435N
FAK8454	Navistar	E-4573	FKP36B	Flagg	E-4440B
FAK8461	Navistar	E-4575	FKP37B	Flagg	E-4442B
FAK8462	Navistar	E-4576	FKP38B	Flagg	E-4430B
FAK8466	Navistar	E-4577	FKP39B	Flagg	E-4443B
FAK8470	Navistar	E-4579	FKP39N	Flagg	E-4443N
FAK8477	Navistar	E-4580	FKP40B	Flagg	E-4444B
FAK8481	Navistar	E-4581	FKP40N	Flagg	E-4444N
FAK8485	Navistar	E-4582	FKP43B	Flagg	E-4445B
FAK8487	Navistar	E-4583	FKP43N	Flagg	E-4445N
FDL1020	Navistar	E-5386	FKP46B	Flagg	E-4438B
FDL1022	Navistar	E-6804	FKP46N	Flagg	E-4438N
FDL1024	Navistar	E-6806	FKP49B	Flagg	E-4449B
FDL1028	Navistar	E-6808	FKP49N	Flagg	E-4449B
FDL1031	Navistar	E-6878	FKP50B	Flagg	E-4442B
FDL1034	Navistar	E-5390	FKP51B	Flagg	E-4448B
FDL1044	Navistar	E-6815	FKP52B	Flagg	E-4454B
FDL1064	Navistar	E-6816	FKP52N	Flagg	E-4454N
FDL1067	Navistar	E-6817	FKP53B	Flagg	E-4441B
FDL1179	Navistar	E-6818	FKP53N	Flagg	E-4441B
FDL1180	Navistar	E-6819	FKP59B	Flagg	E-4598B
FDL1186	Navistar	E-6825	FKP61B	Flagg	E-6453B
FDL1191	Navistar	E-6827	FKP62B	Flagg	E-4450B
FDL1199	Navistar	E-6833	FKP68B	Flagg	E-4451B
FDL1200	Navistar	E-6834	FKP69B	Flagg	E-4452B
FDL1203	Navistar	E-6835	FKP70B	Flagg	E-4453B
FDL1204	Navistar	E-6836	FKP71B	Flagg	E-4458B
FDL1207	Navistar	E-6839	FKP72B	Flagg	E-4459B
FDL1214	Navistar	E-9911	FKP73B	Flagg	E-4457B
FDL1215	Navistar	E-11463	FKP74B	Flagg	E-6451B
FDL800	Navistar	E-5310	FKP75B	Flagg	E-4460B
FDL908	Navistar	E-5325	FKP76B	Flagg	E-4461B
FDL910	Navistar	E-5326	FKP77B	Flagg	E-4462B
FDL948	Navistar	E-5338	FKP77N	Flagg	E-4462B
FDL949	Navistar	E-5339	FKP78B	Flagg	E-4463B
FDL953	Navistar	E-5342	FKP78N	Flagg	E-4463B
FDL979	Navistar	E-5366	FKP81B	Flagg	E-6450B
FDL986	Navistar	E-5372	FKP85B	Flagg	E-4467B
FDL987	Navistar	E-5373	FKP86B	Flagg	E-4469B
FDL988	Navistar	E-5374	FKP88B	Flagg	E-4471B
FDL992	Navistar	E-5378	FKP89B	Flagg	E-4470B
FDL993	Navistar	E-5379	FKP8B	Flagg	E-4431B
FDL994	Navistar	E-5380	FKP90B	Flagg	E-4468B
FKP100C	Flagg	E-4695C	FKP91B	Flagg	E-4697B
FKP101C	Flagg	E-6869C	FKP92B	Flagg	E-6868B
FKP102C	Flagg	E-6454C	FKP93B	Flagg	E-4595B
FKP103C	Flagg	E-6455C	FKP94B	Flagg	E-4599B
FKP104B	Flagg	E-6195B	FKP96B	Flagg	E-4693B
FKP105B	Flagg	E-6196B	FKP97C	Flagg	E-4694C
FKP106B	Flagg	E-6197B	FKP98C	Flagg	E-4696C
FKP107C	Flagg	E-4459C	FKP98C	Flagg	E-6869C
FKP109C	Flagg	E-6194C	FKP99C	Flagg	E-4458C
FKP110B	Flagg	E-6198B	FTR150L	Navistar	E-4634
FKP111C	Flagg	E-6199C	FTR150R	Navistar	E-4635
FKP113C	Flagg	E-6875C	FTR176L	Navistar	E-4636
FKP115B	Flagg	E-4696B	FTR176R	Navistar	E-4637
FKP11B	Flagg	E-4434B	FTR187L	Navistar	E-4610
FKP11N	Flagg	E-4434N	FTR187R	Navistar	E-4611
FKP120B	Flagg	E-9943B	FTR2035L	Navistar	E-4622
FKP121B	Flagg	E-10104B	FTR2036R	Navistar	E-4623

INTERCHANGE

Part Number	Supplier	Euclid Number	Part Number	Supplier	Euclid Number
FTR2040R	Navistar	E-4617	K120W	Kaiser	E-4598B
FTR2061L	Navistar	E-4612	K124R	McQuay	E-4430B
FTR2062R	Navistar	E-4613	K129N	TRW	E-6865B
FTR2069R	Navistar	E-4609	K162-536	Kenworth	E-8732
FTR2070L	Navistar	E-4608	K162280	Kenworth	E-5378
FTR2090L	Navistar	E-4628	K162311	Kenworth	E-5379
FTR2091R	Navistar	E-4629	K162363	Kenworth	E-5380
FTR2113R	Navistar	E-4617	K1N	TRW	E-4442B
FTR2114R	Navistar	E-4617	K391C	TRW	E-4430B
FTR2115R	Navistar	E-4617	K401N	TRW	E-4431B
FTR2116L	Navistar	E-4616	K450	TRW	E-4434B
FTR2118L	Navistar	E-4640	K463	TRW	E-4435B
FTR2200L	Navistar	E-6847	K477	TRW	E-4438B
FTR2201R	Navistar	E-6848	K479	TRW	E-4598B
FTR2202R	Navistar	E-4629	K489	TRW	E-4434N
FTR2203R	Navistar	E-6849	K493	TRW	E-4440B
FTR2204R	Navistar	E-4629	K496	TRW	E-4441B
FTR2207R	Navistar	E-4618	K496B	TRW	E-4441B
FTR2208R	Navistar	E-4642	K499	TRW	E-4435N
FTR2209R	Navistar	E-4629	K503	TRW	E-4438N
FTR2210L	Navistar	E-4628	K506	TRW	E-4443N
FTR2224L	Navistar	E-5391	K506B	TRW	E-4443B
FTR2225R	Navistar	E-5402	K507	TRW	E-4444N
FTR235NL	Navistar	E-4600	K507B	TRW	E-4444B
FTR235NR	Navistar	E-4601	K509	TRW	E-4445N
FTR2613L	Navistar	E-5469	K509B	TRW	E-4445B
FTR2614R	Navistar	E-5470	K50F	Kaiser	E-4440B
FTR3026L	Navistar	E-6854	K510B	TRW	E-4442B
FTR3027R	Navistar	E-6855	K524B	TRW	E-4448B
FTR3030R	Navistar	E-6856	K526	TRW	E-4449B
FTR3031L	Navistar	E-6857	K526B	TRW	E-4449B
FTR3032R	Navistar	E-6858	K526D	TRW	E-4449B
FTR3033L	Navistar	E-4629	K528B	TRW	E-6453B
FTR3034R	Navistar	E-4628	K534B	TRW	E-4450B
FTR3039L	Navistar	E-6863	K535B	TRW	E-4451B
FTR3040R	Navistar	E-6864	K538B	TRW	E-4452B
FTR304L	Navistar	E-4602	K540B	TRW	E-4453B
FTR304R	Navistar	E-4603	K541B	TRW	E-4454B
FTR3057	Navistar	E-4616	K542D	TRW	E-4454N
FTR330L	Navistar	E-4620	K545B	TRW	E-6451B
FTR330R	Navistar	E-4621	K546B	TRW	E-4457B
FTR332L	Navistar	E-4624	K547B	TRW	E-4458B
FTR332R	Navistar	E-4625	K548B	TRW	E-4459B
FTR346L	Navistar	E-4618	K549B	TRW	E-4460B
FTR346R	Navistar	E-4619	K551B	TRW	E-4461B
FTR373L	Navistar	E-4604	K552B	TRW	E-4462B
FTR373R	Navistar	E-4605	K553D	TRW	E-4462B
FTR376L	Navistar	E-4616	K554B	TRW	E-4463B
FTR376R	Navistar	E-4617	K555D	TRW	E-4463B
FTR405L	Navistar	E-4606	K559B	TRW	E-6450B
FTR405R	Navistar	E-4607	K562B	TRW	E-4467B
FTR411L	Navistar	E-4630	K563B	TRW	E-4468B
FTR411R	Navistar	E-4631	K564B	TRW	E-4470B
FTR423L	Navistar	E-4614	K565B	TRW	E-4471B
FTR423R	Navistar	E-4615	K567B	TRW	E-4469B
FTR431R	Navistar	E-4616	K570B	TRW	E-4595B
FTR8407	Navistar	E-4614	K572B	TRW	E-4693B
FTR8408	Navistar	E-4615	K576C	TRW	E-4694C
FTR8409	Navistar	E-9951	K577C	TRW	E-6454C
FTR8410	Navistar	E-9952	K578C	TRW	E-6455C
H1008431	Peterbilt	E-4696C	K582	TRW	E-6868B
K102I	Kaiser	E-6198B	K584	TRW	E-4696C
K109I	Kaiser	E-4448B	K585	TRW	E-4458C

INTERCHANGE

Part Number	Supplier	Euclid Number	Part Number	Supplier	Euclid Number
K586	TRW	E-6869C	KA328	McQuay	E-4471B
K587	TRW	E-6195B	KA331	McQuay	E-4469B
K588	TRW	E-6196B	KA97	McQuay	E-6865B
K589	TRW	E-6197B	KB325	Elgin	E-4451B
K590	TRW	E-4459C	KB391C	Unimotive	E-4430B
K591	TRW	E-6194C	KB401N	Unimotive	E-4431B
K592	TRW	E-6198B	KB425	Elgin	E-4448B
K593	TRW	E-6199C	KB450	Unimotive	E-4434B
K594	TRW	E-6875C	KB450A	Elgin	E-4434B
K617C	TRW	E-6194B	KB450AN	Elgin	E-4434N
K618C	TRW	E-10104B	KB459	Elgin	E-5441B
K619C	TRW	E-10105B	KB462B	Elgin	E-4430B
K620C	TRW	E-10106B	KB463	Elgin	E-4435B
K75F	Kaiser	E-4452B	KB463	Unimotive	E-4435B
K921L	Kaiser	E-4450B	KB463N	Elgin	E-4435N
K931C	Kaiser	E-4459B	KB465A	Elgin	E-4441B
K931F	Kaiser	E-4459B	KB465AN	Elgin	E-4441B
K931L	Kaiser	E-4459B	KB471	Elgin	E-4431B
K95F	Kaiser	E-4457B	KB477	Unimotive	E-4438B
K98I	Kaiser	E-4431B	KB477ANR	Elgin	E-4438N
KA124R	McQuay	E-4430B	KB477AR	Elgin	E-4438B
KA140	McQuay	E-4431B	KB479X	Elgin	E-4598B
KA213	McQuay	E-4435B	KB489	Unimotive	E-4434N
KA218	McQuay	E-4441B	KB491A	Elgin	E-4444B
KA219	McQuay	E-4438B	KB491AN	Elgin	E-4444N
KA227	McQuay	E-4434N	KB492ANR	Elgin	E-4443N
KA234	McQuay	E-4598B	KB492AR	Elgin	E-4443B
KA235	McQuay	E-4438B	KB493	Elgin	E-4440B
KA236	McQuay	E-4434B	KB493	Unimotive	E-4440B
KA239	McQuay	E-4438N	KB496	Unimotive	E-4441B
KA241	McQuay	E-4440B	KB496B	Unimotive	E-4441B
KA246	McQuay	E-4443B	KB499	Unimotive	E-4435N
KA249	McQuay	E-4444N	KB503	Unimotive	E-4438N
KA250	McQuay	E-4443N	KB504	Elgin	E-4442B
KA257	McQuay	E-4442B	KB505A	Elgin	E-4449B
KA258	McQuay	E-4435N	KB505AN	Elgin	E-4449B
KA264	McQuay	E-4445N	KB506	Unimotive	E-4443N
KA277	McQuay	E-4454N	KB506B	Unimotive	E-4443B
KA278	McQuay	E-4454B	KB507	Unimotive	E-4444N
KA279	McQuay	E-4451B	KB507B	Unimotive	E-4444B
KA280	McQuay	E-4448B	KB509	Unimotive	E-4445N
KA281	McQuay	E-4445B	KB509B	Unimotive	E-4445B
KA282	McQuay	E-4441B	KB510B	Unimotive	E-4442B
KA290	McQuay	E-6453B	KB524B	Unimotive	E-4448B
KA291	McQuay	E-4450B	KB526B	Unimotive	E-4449B
KA292	McQuay	E-4449B	KB526D	Unimotive	E-4449B
KA293	McQuay	E-4449B	KB534B	Elgin	E-4450B
KA298	McQuay	E-4444B	KB534B	Unimotive	E-4450B
KA299	McQuay	E-6451B	KB535B	Unimotive	E-4451B
KA300	McQuay	E-4457B	KB537	Elgin	E-4452B
KA301	McQuay	E-4459B	KB538B	Unimotive	E-4452B
KA302	McQuay	E-4458B	KB540B	Unimotive	E-4453B
KA306	McQuay	E-4453B	KB541B	Unimotive	E-4454B
KA307	McQuay	E-4460B	KB542D	Unimotive	E-4454N
KA309	McQuay	E-4463B	KB546	Elgin	E-4457B
KA310	McQuay	E-4462B	KB546B	Unimotive	E-4457B
KA312	McQuay	E-4461B	KB547	Elgin	E-4458B
KA313	McQuay	E-4463B	KB547B	Unimotive	E-4458B
KA314	McQuay	E-4462B	KB548	Elgin	E-4459B
KA317	McQuay	E-4452B	KB548B	Unimotive	E-4459B
KA320	McQuay	E-6450B	KB549B	Unimotive	E-4460B
KA321	McQuay	E-4468B	KB551B	Unimotive	E-4461B
KA325	McQuay	E-4467B	KB552B	Unimotive	E-4462B

INTERCHANGE

Part Number	Supplier	Euclid Number	Part Number	Supplier	Euclid Number
KB553D	Unimotive	E-4462B	KIT156	Volvo White GMC	E-4449B
KB554B	Unimotive	E-4463B	KIT157	Freightliner	E-4449B
KB555D	Unimotive	E-4463B	KIT157	Kenworth	E-4449B
KB562B	Unimotive	E-4467B	KIT157	Marmon	E-4449B
KB563B	Unimotive	E-4468B	KIT157	Meritor	E-4449B
KB564B	Unimotive	E-4470B	KIT157	Peterbilt	E-4449B
KB565B	Unimotive	E-4471B	KIT157	Volvo White GMC	E-4449B
KB567B	Unimotive	E-4469B	KIT168	Freightliner	E-4454N
KB571NR	Elgin	E-4445N	KIT168	Kenworth	E-4454N
KB571R	Elgin	E-4445B	KIT168	Marmon	E-4454N
KB645	Elgin	E-4460B	KIT168	Meritor	E-4454N
KB700	Elgin	E-4454B	KIT168	Peterbilt	E-4454N
KB700N	Elgin	E-4454N	KIT168	Volvo White GMC	E-4454N
KB722	Elgin	E-4453B	KIT170	Freightliner	E-4454B
KB816	Elgin	E-4461B	KIT170	Kenworth	E-4454B
KB817	Elgin	E-4462B	KIT170	Marmon	E-4454B
KB817N	Elgin	E-4462B	KIT170	Meritor	E-4454B
KB818	Elgin	E-4463B	KIT170	Peterbilt	E-4454B
KB818N	Elgin	E-4463B	KIT170	Volvo White GMC	E-4454B
KB823	Elgin	E-4468B	KIT172	Freightliner	E-4442B
KB829	Elgin	E-4467B	KIT172	Kenworth	E-4442B
KB830	Elgin	E-4469B	KIT172	Marmon	E-4442B
KB832	Elgin	E-4471B	KIT172	Meritor	E-4442B
KB834	Elgin	E-4599B	KIT172	Peterbilt	E-4442B
KB835	Elgin	E-4697B	KIT172	Volvo White GMC	E-4442B
KB837	Elgin	E-4595B	KIT195	Freightliner	E-4468B
KB838	Elgin	E-4470B	KIT195	Kenworth	E-4468B
KB839	Elgin	E-4694C	KIT195	Mack	E-4468B
KB840	Elgin	E-4693B	KIT195	Marmon	E-4468B
KIT108	Meritor	E-6865B	KIT195	Meritor	E-4468B
KIT123	Freightliner	E-4434N	KIT195	Peterbilt	E-4468B
KIT123	Kenworth	E-4434N	KIT195	Volvo White GMC	E-4468B
KIT123	Marmon	E-4434N	KIT198	Mack	E-4458B
KIT123	Meritor	E-4434N	KIT198	Marmon	E-4458B
KIT123	Peterbilt	E-4434N	KIT198	Meritor	E-4458B
KIT123	Volvo White GMC	E-4434N	KIT198	Volvo White GMC	E-4458B
KIT1300	Freightliner	E-4595B	KIT199	Freightliner	E-4450B
KIT1300	Kenworth	E-4595B	KIT199	Kenworth	E-4450B
KIT1300	Marmon	E-4595B	KIT199	Marmon	E-4450B
KIT1300	Meritor	E-4595B	KIT199	Meritor	E-4450B
KIT1300	Peterbilt	E-4595B	KIT199	Peterbilt	E-4450B
KIT1307	Kenworth	E-4694C	KIT199	Volvo White GMC	E-4450B
KIT1307	Meritor	E-4694C	KP2262	Eaton	E-4431B
KIT1309	Meritor	E-4695C	KP2266	Eaton	E-4434B
KIT1310	Meritor	E-6868B	KP2268	Eaton	E-4435B
KIT1312	Meritor	E-4458C	KP2271	Eaton	E-4434N
KIT1315	Meritor	E-6199C	KP2272	Eaton	E-4598B
KIT141	Meritor	E-5441B	KP2276	Eaton	E-4435N
KIT142	Meritor	E-4441B	KP2277	Eaton	E-4444N
KIT143	Meritor	E-4438B	KP2278	Eaton	E-4444B
KIT144	Freightliner	E-4434B	KP2279	Eaton	E-4443N
KIT144	Kenworth	E-4434B	KP2280	Eaton	E-4443B
KIT144	Marmon	E-4434B	KP2281	Eaton	E-4430B
KIT144	Meritor	E-4434B	KP2283	Eaton	E-4445N
KIT144	Peterbilt	E-4434B	KP2284	Eaton	E-4445B
KIT144	Volvo White GMC	E-4434B	KP2288	Eaton	E-4441B
KIT154	Meritor	E-4441B	KP2289	Eaton	E-4438B
KIT155	Meritor	E-4438N	KP2290	Eaton	E-4438N
KIT156	Freightliner	E-4449B	KP2291	Eaton	E-4449B
KIT156	Kenworth	E-4449B	KP2292	Eaton	E-4442B
KIT156	Marmon	E-4449B	KP2293	Eaton	E-4448B
KIT156	Meritor	E-4449B	KP2294	Eaton	E-4441B
KIT156	Peterbilt	E-4449B	KP2296	Eaton	E-4454N

INTERCHANGE

Part Number	Supplier	Euclid Number	Part Number	Supplier	Euclid Number
KP2297	Eaton	E-4454B	L24SV5042A12	Autocar	E-4615
KP2298	Eaton	E-4449B	L24SV5042A12	Chrysler	E-4615
KP2305	Eaton	E-4450B	L24SV5042A12	Eaton	E-4615
KP2311	Eaton	E-4451B	L24SV5042A12	Freightliner	E-4615
KP2313	Eaton	E-4452B	L24SV5042A12	GMC	E-4615
KP2314	Eaton	E-4458B	L24SV5042A12	Kenworth	E-4615
KP2315	Eaton	E-4459B	L24SV5042A12	Marmon	E-4615
KP2316	Eaton	E-4457B	L24SV5042A12	Peterbilt	E-4615
KP2318	Eaton	E-4453B	L24SV5042A12	Volvo White GMC	E-4615
KP2320	Eaton	E-4460B	L24SV5042B12	Freightliner	E-4615
KP2322	Eaton	E-4461B	L24SV5043A12	Autocar	E-4614
KP2323	Eaton	E-4462B	L24SV5043A12	Chrysler	E-4614
KP2324	Eaton	E-4462B	L24SV5043A12	Eaton	E-4614
KP2325	Eaton	E-4463B	L24SV5043A12	Freightliner	E-4614
KP2326	Eaton	E-4463B	L24SV5043A12	GMC	E-4614
KP2327	Eaton	E-4468B	L24SV5043A12	Kenworth	E-4614
KP2330	Eaton	E-4467B	L24SV5043A12	Marmon	E-4614
KP2331	Eaton	E-4469B	L24SV5043A12	Peterbilt	E-4614
KP2333	Eaton	E-4471B	L24SV5043A12	TRW	E-4615
KP2334	Eaton	E-4470B	L24SV5043A12	Volvo White GMC	E-4614
KP2336	Eaton	E-4599B	L24SV5043A14	Freightliner	E-4614
KP2337	Eaton	E-4697B	L24SV5108A13	Freightliner	E-9967
KP2339	Eaton	E-4595B	L24SV5700A12	Freightliner	E-6849
KP2340	Eaton	E-4693B	L24SV8002B12	TRW	E-10108
KP2341	Eaton	E-4696C	L24SV8003B13	TRW	E-10109
KP2344	Eaton	E-4440B	L24SV8100A13	TRW	E-4628
KP2372	Eaton	E-4572	L24SV8100D18	TRW	E-11789
KP2373	Eaton	E-4573	L24SV8101A21	TRW	E-4629
KP2375	Eaton	E-4575	L24SV8101E19	TRW	E-11788
KP2376	Eaton	E-4576	L24SV8206A13	TRW	E-5391
KP2377	Eaton	E-4577	L24SV8208B12	TRW	E-9878
KP2379	Eaton	E-4579	L24SV8209B12	TRW	E-9877
KP2380	Eaton	E-4580	L24VT7035A11	Kenworth	E-8732
KP2381	Eaton	E-4581	L24VU7061A11	Kenworth	E-6825
KP2382	Eaton	E-4582	L24VU8008B11	Kenworth	E-6825
KP2384	Eaton	E-4583	L24VU8108A11	TRW	E-11790
KP4573	Eaton	E-4573	L28SV5000A14	Freightliner	E-4616
KPS10	Flagg	E-4575	L28SV5000A18	Freightliner	E-4616
KPS11	Flagg	E-4576	L28SV5000A30	Freightliner	E-4618
KPS12	Flagg	E-4577	L28SV5000H29	Freightliner	E-4616
KPS14	Flagg	E-4579	L28SV5000H35	Freightliner	E-4616
KPS15	Flagg	E-4580	L28SV5001A18	Freightliner	E-4617
KPS16	Flagg	E-4581	L28SV5003A14	Freightliner	E-4619
KPS17	Flagg	E-4582	L28SV5003B18	Freightliner	E-4617
KPS18	Flagg	E-4583	L28SV5004D1	Freightliner	E-4617
KPS7	Flagg	E-4572	L28SV5004D1	Volvo White GMC	E-4617
KPS8	Flagg	E-4573	L28SV5015A14	Freightliner	E-4642
KW1	Flagg	E-4642	L28SV5200A12	Freightliner	E-4629
L18VU8000A12	TRW	E-11463	L28SV5200D12	Freightliner	E-4629
L20LV8041A14	TRW	E-8757	L28SV5201A12	Freightliner	E-4628
L20LV8042A14	TRW	E-8758	L28SV5201D12	Freightliner	E-4628
L20SV8100D12	TRW	E-4614	L28SV5202A1	Kenworth	E-4629
L20SV8101D12	TRW	E-4615	L28SV5203A1	Kenworth	E-4628
L20SV8102B12	TRW	E-10110	L28SV5207B16	Freightliner	E-4629
L20SV8103B12	TRW	E-10111	L2AVT7035A11	Kenworth	E-8732
L20SV8115A12	TRW	E-4610	LSOSV8116A12	TRW	E-4610
L20SV8116A12	TRW	E-4611	M2300	BWP	E-4430B
L20SV8150A13	TRW	E-10137	M2300103	Midland	E-6865B
L20SV8151A13	TRW	E-10138	M2300107	Midland	E-4430B
L24SV5000H17	Freightliner	E-4608	M2300110	Midland	E-4431B
L24SV5001A13	Freightliner	E-4611	M2300125	Midland	E-4434B
L24SV5001A14	Freightliner	E-4611	M2300128	Midland	E-4435B
L24SV5001D23	Freightliner	E-4609	M2300140	Midland	E-4438B

INTERCHANGE

Part Number	Supplier	Euclid Number	Part Number	Supplier	Euclid Number
M2300142	Midland	E-4598B	M2300283	Midland	E-6194B
M2300150	Midland	E-4434N	M2300284	Midland	E-6199B
M2300155	Midland	E-4440B	M2301	BWP	E-4431B
M2300158	Midland	E-4441B	M2305	BWP	E-4434B
M2300159	Midland	E-4441B	M2306	BWP	E-4435B
M2300163	Midland	E-4435N	M2309	BWP	E-4434N
M2300170	Midland	E-4438N	M2310	BWP	E-4440B
M2300172	Midland	E-4443N	M2310455	Midland	E-10137
M2300173	Midland	E-4443B	M2310456	Midland	E-10138
M2300174	Midland	E-4444N	M2311	BWP	E-4441B
M2300175	Midland	E-4444B	M2312	BWP	E-4441B
M2300179	Midland	E-4445N	M2313	BWP	E-4435N
M2300180	Midland	E-4445B	M2316	BWP	E-4443N
M2300182	Midland	E-4442B	M2317	BWP	E-4443B
M2300194	Midland	E-4448B	M2318	BWP	E-4444N
M2300195	Midland	E-4449B	M2319	BWP	E-4444B
M2300196	Midland	E-4449B	M2320	BWP	E-4445N
M2300198	Midland	E-6453B	M2321	BWP	E-4445B
M2300204	Midland	E-4450B	M2322	BWP	E-4442B
M2300205	Midland	E-4451B	M2325	BWP	E-4448B
M2300207	Midland	E-4452B	M2326	BWP	E-4449B
M2300209	Midland	E-4453B	M2327	BWP	E-4449B
M2300210	Midland	E-4454B	M2331	BWP	E-4450B
M2300211	Midland	E-4454N	M2332	BWP	E-4451B
M2300214	Midland	E-6451B	M2334	BWP	E-4452B
M2300215	Midland	E-4457B	M2336	BWP	E-4454B
M2300216	Midland	E-4458B	M2338	BWP	E-4457B
M2300217	Midland	E-4459B	M2339	BWP	E-4458B
M2300218	Midland	E-4460B	M2340	BWP	E-4459B
M2300220	Midland	E-4461B	M2341	BWP	E-4460B
M2300221	Midland	E-4462B	M2342	BWP	E-4461B
M2300222	Midland	E-4462B	M2343	BWP	E-4462B
M2300223	Midland	E-4463B	M2344	BWP	E-4462B
M2300224	Midland	E-4463B	M2345	BWP	E-4463B
M2300228	Midland	E-6450B	M2347	BWP	E-4467B
M2300231	Midland	E-4467B	M2348	BWP	E-4468B
M2300232	Midland	E-4468B	M2349	BWP	E-4471B
M2300233	Midland	E-4469B	M2350	BWP	E-4469B
M2300234	Midland	E-4470B	M2351	BWP	E-4598B
M2300235	Midland	E-4471B	M2352	BWP	E-4454N
M2300240	Midland	E-4595B	M2358	BWP	E-4595B
M2300242	Midland	E-4694C	M2363	BWP	E-4438B
M2300244	Midland	E-4695C	M2366	BWP	E-6453B
M2300245	Midland	E-4599B	M2370	BWP	E-4453B
M2300248	Midland	E-4697B	M2373	BWP	E-4463B
M2300249	Midland	E-4693B	M2375	BWP	E-6450B
M2300257	Midland	E-4696C	M2378	BWP	E-4470B
M2300258	Midland	E-6869C	M2379	BWP	E-4697B
M2300259	Midland	E-6454C	M2380	BWP	E-4693B
M2300260	Midland	E-6195B	M2381	BWP	E-4694C
M2300261	Midland	E-4459C	M2382	BWP	E-4696C
M2300262	Midland	E-6196B	M2383	BWP	E-6869C
M2300263	Midland	E-6197B	M2384	BWP	E-6198B
M2300264	Midland	E-6868B	M2385	BWP	E-6199C
M2300265	Midland	E-4458C	M2387	BWP	E-6875C
M2300266	Midland	E-6199C	M2DS1020	Midland	E-5386
M2300267	Midland	E-6194C	M2DS1022	Midland	E-6804
M2300268	Midland	E-6198B	M2DS1024	Midland	E-6806
M2300269	Midland	E-6875C	M2DS1028	Midland	E-6808
M2300273	Midland	E-6455C	M2DS1031	Midland	E-6878
M2300274	Midland	E-4696B	M2DS1034	Midland	E-5390
M2300276	Midland	E-9941B	M2DS1044	Midland	E-6815
M2300279	Midland	E-6454B	M2DS1064	Midland	E-6816

INTERCHANGE

Part Number	Supplier	Euclid Number	Part Number	Supplier	Euclid Number
M2DS1067	Midland	E-6817	M2ES304L	Midland	E-4602
M2DS1179	Midland	E-6818	M2ES304R	Midland	E-4603
M2DS1180	Midland	E-6819	M2ES3056	Midland	E-4617
M2DS1186	Midland	E-6825	M2ES3057	Midland	E-4616
M2DS1191	Midland	E-6827	M2ES3252R	Midland	E-9881
M2DS1199	Midland	E-6833	M2ES3297R	Midland	E-8758
M2DS1200	Midland	E-6834	M2ES3298L	Midland	E-8757
M2DS1203	Midland	E-6835	M2ES330L	Midland	E-4620
M2DS1204	Midland	E-6836	M2ES332L	Midland	E-4624
M2DS1214	Midland	E-9911	M2ES332R	Midland	E-4625
M2DS1218	Midland	E-9897	M2ES33OR	Midland	E-4621
M2DS1234	Midland	E-9931	M2ES346L	Midland	E-4618
M2DS1261	Midland	E-9961	M2ES346R	Midland	E-4619
M2DS1265	Midland	E-9925	M2ES373L	Midland	E-4604
M2DS1266	Midland	E-9926	M2ES373R	Midland	E-4605
M2DS1268	Midland	E-9927	M2ES405L	Midland	E-4606
M2DS1269	Midland	E-9929	M2ES405R	Midland	E-4607
M2DS1270	Midland	E-9933	M2ES411L	Midland	E-4630
M2DS1271	Midland	E-9934	M2ES411R	Midland	E-4631
M2DS1362S	Midland	E-9960	M2ES423L	Midland	E-4614
M2DS1366	Midland	E-9937	M2ES423R	Midland	E-4615
M2DS1367A	Midland	E-9959	M2ES431L	Midland	E-4616
M2DS1368A	Midland	E-9964	M2ES431R	Midland	E-4617
M2DS1369	Midland	E-9936	R200001	Meritor	E-4430B
M2DS1379S	Midland	E-9957	R200003	Meritor	E-4431B
M2DS1380S	Midland	E-9958	R200011	Meritor	E-4435B
M2DS800	Midland	E-5310	R200017	Meritor	E-4598B
M2DS908	Midland	E-5325	R200018	Meritor	E-4440B
M2DS910	Midland	E-5326	R200022	Meritor	E-4435N
M2DS948	Midland	E-5338	R200024	Meritor	E-4443N
M2DS949	Midland	E-5339	R200025	Meritor	E-4443B
M2DS953	Midland	E-5342	R200026	Meritor	E-4444N
M2DS979	Midland	E-5366	R200027	Meritor	E-4444B
M2DS986	Midland	E-5372	R200028	Meritor	E-4445N
M2DS987	Midland	E-5373	R200029	Meritor	E-4445B
M2DS988	Midland	E-5374	R200034	Meritor	E-4448B
M2DS992	Midland	E-5378	R200036	Meritor	E-6453B
M2DS993	Midland	E-5379	R200042	Meritor	E-4451B
M2DS994	Midland	E-5380	R200044	Meritor	E-4452B
M2ES176L	Midland	E-4636	R200046	Meritor	E-4453B
M2ES176R	Midland	E-4637	R200049	Meritor	E-6451B
M2ES187L	Midland	E-4610	R200050	Meritor	E-4457B
M2ES187R	Midland	E-4611	R200051	Meritor	E-4459B
M2ES2035L	Midland	E-4622	R200052	Meritor	E-4460B
M2ES2036R	Midland	E-4623	R200054	Meritor	E-4461B
M2ES2061L	Midland	E-4612	R200055	Meritor	E-4462B
M2ES2062R	Midland	E-4613	R200056	Meritor	E-4462B
M2ES2069R	Midland	E-4609	R200057	Meritor	E-4463B
M2ES2070L	Midland	E-4608	R200058	Meritor	E-4463B
M2ES2090L	Midland	E-4628	R200062	Meritor	E-6450B
M2ES2091R	Midland	E-4629	R200065	Meritor	E-4467B
M2ES2118L	Midland	E-4640	R200066	Meritor	E-4469B
M2ES2202R	Midland	E-4629	R200067	Meritor	E-4470B
M2ES2208R	Midland	E-4642	R200068	Meritor	E-4471B
M2ES2224L	Midland	E-5391	R200071	Meritor	E-4599B
M2ES2225R	Midland	E-5402	R200073	Meritor	E-4697B
M2ES235NL	Midland	E-4600	R200074	Meritor	E-4693B
M2ES235NR	Midland	E-4601	R200123	Meritor	E-4434N
M2ES2613L	Midland	E-5469	R200141	Meritor	E-5441B
M2ES2614R	Midland	E-5470	R200142	Meritor	E-4441B
M2ES3031L	Midland	E-6857	R200143	Meritor	E-4438B
M2ES3032R	Midland	E-6858	R200144	Meritor	E-4434B
M2ES303OR	Midland	E-6856	R200154	Meritor	E-4441B

INTERCHANGE

Part Number	Supplier	Euclid Number	Part Number	Supplier	Euclid Number
R200155	Meritor	E-4438N	R230024	Meritor	E-4606
R200156	Meritor	E-4449B	R230025	Meritor	E-4607
R200157	Meritor	E-4449B	R230028	Meritor	E-4630
R200168	Meritor	E-4454N	R230029	Meritor	E-4631
R200170	Meritor	E-4454B	R230030	Meritor	E-4622
R200172	Meritor	E-4442B	R230031	Meritor	E-4623
R200184	Meritor	E-4441B	R230034	Meritor	E-4612
R200186	Meritor	E-4434B	R230035	Meritor	E-4613
R200188	Meritor	E-4449B	R230036	Meritor	E-4609
R200189	Meritor	E-4454B	R230037	Meritor	E-4608
R200190	Meritor	E-4442B	R230040	Meritor	E-5391
R200193	Meritor	E-4450B	R230041	Meritor	E-9877
R200195	Meritor	E-4468B	R230042	Meritor	E-9878
R200198	Meritor	E-4458B	R230043	Meritor	E-4640
R200199	Meritor	E-4450B	R230050	Meritor	E-4629
R200250	Meritor	E-6194C	R230051	Meritor	E-6849
R200251	Meritor	E-6869C	R230052	Meritor	E-4629
R200267	Meritor	E-4696C	R230055	Meritor	E-4628
R200268	Meritor	E-6198B	R230056	Meritor	E-5402
R200269	Meritor	E-4696B	R230060	Meritor	E-4610
R200272	Meritor	E-6195B	R230061	Meritor	E-4611
R200273	Meritor	E-6196B	R230062	Meritor	E-4602
R200275	Meritor	E-6197B	R230063	Meritor	E-4603
R200276	Meritor	E-4459C	R230066	Meritor	E-4619
R200278	Meritor	E-6875C	R230067	Meritor	E-4618
R200280	Meritor	E-9943B	R230068	Meritor	E-4614
R200281	Meritor	E-11394B	R230069	Meritor	E-4615
R201300	Meritor	E-4595B	R230070	Meritor	E-4617
R201307	Meritor	E-4694C	R230071	Meritor	E-4616
R201309	Meritor	E-4695C	R230072	Meritor	E-4628
R201310	Meritor	E-6868B	R230073	Meritor	E-4629
R201312	Meritor	E-4458C	R230074	Meritor	E-6847
R201315	Meritor	E-6199C	R230075	Meritor	E-6848
R201426	Meritor	E-9941B	R230076	Meritor	E-4618
R201427	Meritor	E-9942B	R230077	Meritor	E-4642
R201600	Meritor	E-6454C	R230088	Meritor	E-4610
R201601	Meritor	E-6455C	R230095	Meritor	E-6858
R210203	Meritor	E-9221	R230102	Meritor	E-4629
R210207	Meritor	E-4572	R230103	Meritor	E-4628
R210208	Meritor	E-4573	R230104	Meritor	E-6856
R210210	Meritor	E-4575	R230105	Meritor	E-6857
R210211	Meritor	E-4576	R230117	Meritor	E-6863
R210214	Meritor	E-4577	R230118	Meritor	E-6864
R210215	Meritor	E-4579	R230139	Meritor	E-10137
R210218	Meritor	E-4579	R230140	Meritor	E-10138
R210222	Meritor	E-4580	R230141	Meritor	E-10108
R210223	Meritor	E-4581	R230142	Meritor	E-10109
R210227	Meritor	E-4582	R230143	Meritor	E-10110
R210228	Meritor	E-4583	R230144	Meritor	E-10111
R230002	Meritor	E-4634	R230145	Meritor	E-11788
R230003	Meritor	E-4635	R230146	Meritor	E-11789
R230004	Meritor	E-4636	R230209	Meritor	E-6854
R230005	Meritor	E-4637	R230210	Meritor	E-6855
R230006	Meritor	E-4600	R230213	Meritor	E-4628
R230007	Meritor	E-4601	R230214	Meritor	E-4629
R230008	Meritor	E-4620	R230217	Meritor	E-6135
R230009	Meritor	E-4621	R230218	Meritor	E-6136
R230012	Meritor	E-4624	R230230	Meritor	E-5470
R230013	Meritor	E-4625	R230231	Meritor	E-5469
R230018	Meritor	E-4604	R230405	Meritor	E-5392
R230019	Meritor	E-4605	R230407	Meritor	E-6858
R230022	Meritor	E-9878	R230408	Meritor	E-9962
R230023	Meritor	E-9877	R230408	Meritor	E-9963

INTERCHANGE

Part Number	Supplier	Euclid Number	Part Number	Supplier	Euclid Number
R230409	Meritor	E-9962	R250395	Meritor	E-9936
R230409	Meritor	E-9963	R250398	Meritor	E-9957
R230411	Meritor	E-9948	R250399	Meritor	E-9958
R230413	Meritor	E-4614	R250401	Meritor	E-9926
R230414	Meritor	E-4615	S3596	S & S Parts	E-4461B
R230415	Meritor	E-9951	S4382	S & S Parts	E-5325
R230416	Meritor	E-9952	S4603	S & S Parts	E-5390
R230417	Meritor	E-9881	S4760	S & S Parts	E-4629
R230418	Meritor	E-9966	S4767	S & S Parts	E-4605
R230419	Meritor	E-9965	S4768	S & S Parts	E-4604
R230420	Meritor	E-8758	S4948	S & S Parts	E-4462B
R230421	Meritor	E-8757	S4949	S & S Parts	E-4463B
R230422	Meritor	E-9967	S4988	S & S Parts	E-4693B
R230501	Meritor	E-6665	S4996	S & S Parts	E-4431B
R230511	Meritor	E-6678	S5048	S & S Parts	E-4616
R230526	Meritor	E-6789	S5049	S & S Parts	E-4617
R230527	Meritor	E-6694	S5056	S & S Parts	E-4610
R250001	Meritor	E-6816	S5057	S & S Parts	E-4611
R250012	Meritor	E-5310	S5134	S & S Parts	E-4697B
R250025	Meritor	E-5325	S5223	S & S Parts	E-4460B
R250026	Meritor	E-5326	S5988	S & S Parts	E-4629
R250033	Meritor	E-5338	S6072	S & S Parts	E-4467B
R250034	Meritor	E-5339	S6073	S & S Parts	E-4599B
R250036	Meritor	E-5342	S6485	S & S Parts	E-4696C
R250051	Meritor	E-5366	S6486	S & S Parts	E-6869C
R250052	Meritor	E-5372	S6488	S & S Parts	E-4445B
R250053	Meritor	E-5373	S6492	S & S Parts	E-4438B
R250054	Meritor	E-5374	S6493	S & S Parts	E-4440B
R250055	Meritor	E-5378	S6494	S & S Parts	E-4445N
R250056	Meritor	E-5379	S6500	S & S Parts	E-4623
R250057	Meritor	E-5380	S6501	S & S Parts	E-6451B
R250063	Meritor	E-5386	S6502	S & S Parts	E-4459B
R250066	Meritor	E-5390	S6503	S & S Parts	E-4457B
R250067	Meritor	E-6818	S6504	S & S Parts	E-4452B
R250068	Meritor	E-6819	S6634	S & S Parts	E-4444N
R250085	Meritor	E-6808	S6635	S & S Parts	E-4443N
R250088	Meritor	E-6825	S6642	S & S Parts	E-4435N
R250093	Meritor	E-6806	S6643	S & S Parts	E-4469B
R250095	Meritor	E-6827	S6659	S & S Parts	E-4628
R250103	Meritor	E-6833	S6663	S & S Parts	E-4448B
R250104	Meritor	E-6834	S6936	S & S Parts	E-4434N
R250105	Meritor	E-6836	S6938	S & S Parts	E-4441B
R250112	Meritor	E-9911	S6939A	S & S Parts	E-4434B
R250113	Meritor	E-11463	S6942	S & S Parts	E-4449B
R250120	Meritor	E-9897	S6943	S & S Parts	E-4449B
R250124	Meritor	E-11790	S6945	S & S Parts	E-4454N
R250335	Meritor	E-6804	S6946	S & S Parts	E-4454B
R250340	Meritor	E-6878	S6947	S & S Parts	E-4442B
R250345	Meritor	E-6815	S6948	S & S Parts	E-4468B
R250346	Meritor	E-6817	S6949	S & S Parts	E-4458B
R250347	Meritor	E-6835	S6950	S & S Parts	E-4450B
R250348	Meritor	E-6839	S6963	S & S Parts	E-4595B
R250349	Meritor	E-9931	S6964	S & S Parts	E-4694C
R250354	Meritor	E-9961	S6965	S & S Parts	E-4695C
R250357	Meritor	E-9925	S7190	S & S Parts	E-4598B
R250359	Meritor	E-9927	S7191	S & S Parts	E-4471B
R250360	Meritor	E-9929	S7357	S & S Parts	E-4615
R250361	Meritor	E-9933	S7358	S & S Parts	E-4614
R250362	Meritor	E-9934	S7459	S & S Parts	E-4630
R250390	Meritor	E-9960	S7460	S & S Parts	E-4631
R250392	Meritor	E-9937	S7673	S & S Parts	E-4622
R250393	Meritor	E-9959	S7721	S & S Parts	E-4443B
R250394	Meritor	E-9964	S7801	S & S Parts	E-4451B

INTERCHANGE

Part Number	Supplier	Euclid Number	Part Number	Supplier	Euclid Number
S8157	S & S Parts	E-6789	SP692022	Spicer	E-4634
S8184	S & S Parts	E-6835	SP692023	Spicer	E-4635
S8292	S & S Parts	E-5310	SP692032	Spicer	E-4636
S8293	S & S Parts	E-6816	SP692033	Spicer	E-4637
S8294	S & S Parts	E-5339	SP692041	Spicer	E-4610
S8371	S & S Parts	E-4696B	SP692042	Spicer	E-4611
S8513	S & S Parts	E-6868B	SP692051	Spicer	E-4600
S8529	S & S Parts	E-4458C	SP692052	Spicer	E-4601
S8634	S & S Parts	E-4609	SP692097	Spicer	E-4602
S8635	S & S Parts	E-4608	SP692098	Spicer	E-4603
S8999	S & S Parts	E-8757	SP692138	Spicer	E-4620
S9000	S & S Parts	E-8758	SP692139	Spicer	E-4621
S9327	S & S Parts	E-4430B	SP692142	Spicer	E-4624
SP621016	Spicer	E-4444B	SP692143	Spicer	E-4625
SP621017	Spicer	E-4443B	SP692158	Spicer	E-4618
SP621018	Spicer	E-4445B	SP692159	Spicer	E-4619
SP621275	Spicer	E-6865B	SP692189	Spicer	E-4604
SP621336	Spicer	E-4431B	SP692190	Spicer	E-4605
SP621364	Spicer	E-4434B	SP692234	Spicer	E-4630
SP621406	Spicer	E-4435B	SP692235	Spicer	E-4631
SP621414	Spicer	E-4441B	SP692243	Spicer	E-4614
SP621421	Spicer	E-4438B	SP692244	Spicer	E-4615
SP621422	Spicer	E-4434N	SP692311	Spicer	E-4617
SP621425	Spicer	E-4441B	SP692314	Spicer	E-4606
SP621431	Spicer	E-4438N	SP692315	Spicer	E-4607
SP621443	Spicer	E-4598B	SP692337	Spicer	E-6720
SP621461	Spicer	E-4440B	SP692432	Spicer	E-5392
SP621467	Spicer	E-4435N	SP692437	Spicer	E-4622
SP621472	Spicer	E-4444N	SP692438	Spicer	E-4623
SP621473	Spicer	E-4443N	SP692441	Spicer	E-6403
SP621475	Spicer	E-4430B	SP692442	Spicer	E-6404
SP621483	Spicer	E-4445N	SP692448	Spicer	E-6665
SP621491	Spicer	E-4451B	SP692466	Spicer	E-4612
SP621506	Spicer	E-4449B	SP692467	Spicer	E-4613
SP621507	Spicer	E-4442B	SP692474	Spicer	E-4609
SP621509	Spicer	E-4448B	SP692475	Spicer	E-4608
SP621512	Spicer	E-4454N	SP692485	Spicer	E-4629
SP621513	Spicer	E-4454B	SP692486	Spicer	E-4628
SP621514	Spicer	E-4449B	SP692491	Spicer	E-6678
SP621524	Spicer	E-6453B	SP692553	Spicer	E-6722
SP621525	Spicer	E-4450B	SP692644	Spicer	E-4617
SP621537	Spicer	E-4452B	SP692645	Spicer	E-4616
SP621548	Spicer	E-4453B	SP692653	Spicer	E-4640
SP621549	Spicer	E-6451B	SP692698	Spicer	E-4629
SP621550	Spicer	E-4459B	SP692700	Spicer	E-5391
SP621551	Spicer	E-4457B	SP692701	Spicer	E-5402
SP621554	Spicer	E-4458B	SP692703	Spicer	E-6847
SP621555	Spicer	E-4460B	SP692704	Spicer	E-6848
SP621557	Spicer	E-4461B	SP692705	Spicer	E-6849
SP621558	Spicer	E-4462B	SP692709	Spicer	E-4618
SP621559	Spicer	E-4462B	SP692710	Spicer	E-4642
SP621560	Spicer	E-4463B	SP692733	Spicer	E-6694
SP621561	Spicer	E-4463B	SP692736	Spicer	E-6789
SP621563	Spicer	E-6450B	SP721020	Spicer	E-5310
SP621569	Spicer	E-4467B	SP721036	Spicer	E-5374
SP621572	Spicer	E-4468B	SP721131	Spicer	E-5326
SP621576	Spicer	E-4471B	SP721150	Spicer	E-5325
SP621577	Spicer	E-4470B	SP721579	Spicer	E-5373
SP621580	Spicer	E-4595B	SP721582	Spicer	E-5372
SP621582	Spicer	E-4469B	SP721583	Spicer	E-5366
SP621587	Spicer	E-6455C	SP721590	Spicer	E-5339
SP621588	Spicer	E-6454C	SP721593	Spicer	E-6815
SP672441	Spicer	E-6403	SP721600	Spicer	E-5338

INTERCHANGE

Part Number	Supplier	Euclid Number	Part Number	Supplier	Euclid Number
SP721602	Spicer	E-6817	TR176R	Unimotive	E-4637
SP721603	Spicer	E-6816	TR187L	Unimotive	E-4610
SP721604	Spicer	E-5390	TR187R	Unimotive	E-4611
SP721620	Spicer	E-5386	TR2030R	Unimotive	E-5392
SP721623	Spicer	E-6804	TR2035L	Unimotive	E-4622
SP721624	Spicer	E-6806	TR2036R	Unimotive	E-4623
SP721626	Spicer	E-6808	TR2040R	Unimotive	E-4617
SP724124	Spicer	E-5378	TR2041L	Unimotive	E-4616
SP724125	Spicer	E-5380	TR2061L	Unimotive	E-4612
SP724126	Spicer	E-5379	TR2062R	Unimotive	E-4613
SP724148	Spicer	E-5342	TR2069R	Unimotive	E-4609
TE2003	Eaton	E-4634	TR2070L	Unimotive	E-4608
TE2004	Eaton	E-4635	TR2090L	Unimotive	E-4628
TE2005	Eaton	E-4636	TR2091R	Unimotive	E-4629
TE2006	Eaton	E-4637	TR2113R	Unimotive	E-4617
TE2007	Eaton	E-4610	TR2114R	Unimotive	E-4617
TE2008	Eaton	E-4611	TR2115R	Unimotive	E-4617
TE2009	Eaton	E-4600	TR2116L	Unimotive	E-4616
TE2010	Eaton	E-4601	TR2118L	Unimotive	E-4640
TE2011	Eaton	E-4602	TR2202R	Unimotive	E-4629
TE2012	Eaton	E-4603	TR2204R	Unimotive	E-4629
TE2013	Eaton	E-4620	TR2207R	Unimotive	E-4618
TE2014	Eaton	E-4621	TR2208R	Unimotive	E-4642
TE2015	Eaton	E-4624	TR2209R	Unimotive	E-4629
TE2016	Eaton	E-4625	TR2210L	Unimotive	E-4628
TE2017	Eaton	E-4619	TR2224L	Unimotive	E-5391
TE2018	Eaton	E-4618	TR235NL	Unimotive	E-4600
TE2019	Eaton	E-4604	TR235NR	Unimotive	E-4601
TE2020	Eaton	E-4605	TR304L	Unimotive	E-4602
TE2021	Eaton	E-4616	TR304R	Unimotive	E-4603
TE2022	Eaton	E-4617	TR330L	Unimotive	E-4620
TE2023	Eaton	E-4606	TR330R	Unimotive	E-4621
TE2024	Eaton	E-4607	TR332L	Unimotive	E-4624
TE2026	Eaton	E-4631	TR332R	Unimotive	E-4625
TE2027	Eaton	E-4630	TR346L	Unimotive	E-4618
TE2029	Eaton	E-4614	TR346R	Unimotive	E-4619
TE2030	Eaton	E-4615	TR373L	Unimotive	E-4604
TE2033	Eaton	E-4622	TR373R	Unimotive	E-4605
TE2034	Eaton	E-4623	TR376L	Unimotive	E-4616
TE2035	Eaton	E-4612	TR376R	Unimotive	E-4617
TE2036	Eaton	E-4613	TR405L	Unimotive	E-4606
TE2037	Eaton	E-4608	TR405R	Unimotive	E-4607
TE2038	Eaton	E-4609	TR411L	Unimotive	E-4630
TE2041	Eaton	E-4628	TR411R	Unimotive	E-4631
TE2042	Eaton	E-4629	TR423L	Unimotive	E-4614
TE2043	Eaton	E-4617	TR423R	Unimotive	E-4615
TE2044	Eaton	E-4617	TR431R	Unimotive	E-4616
TE2045	Eaton	E-4616	V1091562	Volvo White GMC	E-4614
TE2046	Eaton	E-4640	V1091563	Volvo White GMC	E-4615
TE2349	Eaton	E-4629	V1110067	Volvo White GMC	E-4628
TE2350	Eaton	E-4629	V1110068	Volvo White GMC	E-4629
TE2453	Eaton	E-4617	V111067	Volvo White GMC	E-4629
TR150L	Unimotive	E-4634	V111068	Volvo White GMC	E-4628
TR150R	Unimotive	E-4635	V1112400	Volvo White GMC	E-6869C
TR176L	Unimotive	E-4636	V276193	Volvo White GMC	E-10166N

MASTER PART NUMBER INDEX

Part No.	Page	Part No.	Page	Part No.	Page	Part No.	Page
10-10B	Catalog 100	145143	Catalog 754	83007	Catalog 754	83215	Catalog 754
10-10S	Catalog 100	145144	Catalog 754	83008	Catalog 754	83216	Catalog 754
10-12B	Catalog 100	145147	Catalog 754	83009	Catalog 754	83217	Catalog 754
10-7B	Catalog 100	145148	Catalog 754	83010	Catalog 754	83219	Catalog 754
10-7S	Catalog 100	145149	Catalog 754	83011	Catalog 754	83221	Catalog 754
10-8.5S	Catalog 100	20-10B	Catalog 100	83012	Catalog 754	83225	Catalog 754
10-8B	Catalog 100	20-8.5S	Catalog 100	83013	Catalog 754	83301	Catalog 754
10-8S	Catalog 100	20-8B	Catalog 100	83014	Catalog 754	83303	Catalog 754
10-9B	Catalog 100	20-8S	Catalog 100	83015	Catalog 754	83304	Catalog 754
10-9S	Catalog 100	20-9B	Catalog 100	83016	Catalog 754	83308	Catalog 754
140126	Catalog 754	20-9S	Catalog 100	83017	Catalog 754	83309	Catalog 754
140169	Catalog 754	4-4.5B	Catalog 100	83018	Catalog 754	83312	Catalog 754
140357	Catalog 754	4-4B	Catalog 100	83019	Catalog 754	83314	Catalog 754
140455	Catalog 754	4-5B	Catalog 100	83020	Catalog 754	83317	Catalog 754
140524	Catalog 754	4-6B	Catalog 100	83021	Catalog 754	83318	Catalog 754
140526	Catalog 754	4-7B	Catalog 100	83022	Catalog 754	83353	Catalog 754
140673	Catalog 754	401750	Catalog 754	83023	Catalog 754	83362	Catalog 754
140689	Catalog 754	402041	Catalog 754	83024	Catalog 754	83400	Catalog 754
140702	Catalog 754	4400	Catalog 754	83025	Catalog 754	83401	Catalog 754
140719	Catalog 754	4457	Catalog 754	83026	Catalog 754	83456	Catalog 754
140780	Catalog 754	4552RB	Catalog 754	83027	Catalog 754	83613	Catalog 754
140857	Catalog 754	5-12B	Catalog 100	83028	Catalog 754	83634	Catalog 754
140884	Catalog 754	5-4B	Catalog 100	83029	Catalog 754	83635	Catalog 754
140885	Catalog 754	5-5B	Catalog 100	83030	Catalog 754	83636	Catalog 754
140921	Catalog 754	5-6B	Catalog 100	83031	Catalog 754	85000	Catalog 754
140947	Catalog 754	630811	Catalog 754	83032	Catalog 754	85001	Catalog 754
141041	Catalog 754	632147	Catalog 754	83033	Catalog 754	85003	Catalog 754
141045	Catalog 754	632155	Catalog 754	83034	Catalog 754	85004	Catalog 754
141047	Catalog 754	665937	Catalog 754	83035	Catalog 754	85005	Catalog 754
141083	Catalog 754	7-10B	Catalog 100	83100	Catalog 754	85006	Catalog 754
141108	Catalog 754	7-12B	Catalog 100	83101	Catalog 754	85007	Catalog 754
141137	Catalog 754	7-16B	Catalog 100	83102	Catalog 754	85009	Catalog 754
141138	Catalog 754	7-4B	Catalog 100	83103	Catalog 754	85010	Catalog 754
141168	Catalog 754	7-5B	Catalog 100	83104	Catalog 754	85011	Catalog 754
141247	Catalog 754	7-6B	Catalog 100	83105	Catalog 754	85012	Catalog 754
141349	Catalog 754	7-6S	Catalog 100	83106	Catalog 754	85013	Catalog 754
141350	Catalog 754	7-7B	Catalog 100	83107	Catalog 754	85014	Catalog 754
141353	Catalog 754	7-7S	Catalog 100	83109	Catalog 754	85023	Catalog 754
141354	Catalog 754	7-8B	Catalog 100	83110	Catalog 754	85024	Catalog 754
141356	Catalog 754	7-9B	Catalog 100	83111	Catalog 754	85025	Catalog 754
141368	Catalog 754	78023	Catalog 754	83112	Catalog 754	85026	Catalog 754
141376	Catalog 754	78049	Catalog 754	83113	Catalog 754	85027	Catalog 754
141439	Catalog 754	78050	Catalog 754	83114	Catalog 754	85029	Catalog 754
141448	Catalog 754	78076	Catalog 754	83115	Catalog 754	85030	Catalog 754
141514	Catalog 754	78077	Catalog 754	83116	Catalog 754	85031	Catalog 754
141537	Catalog 754	78097	Catalog 754	83117	Catalog 754	85033	Catalog 754
141665	Catalog 754	78098	Catalog 754	83118	Catalog 754	85036	Catalog 754
142069	Catalog 754	8-10B	Catalog 100	83119	Catalog 754	85040	Catalog 754
142095	Catalog 754	8-10S	Catalog 100	83120	Catalog 754	85042	Catalog 754
142816	Catalog 754	8-12B	Catalog 100	83121	Catalog 754	85043	Catalog 754
145054	Catalog 754	8-6B	Catalog 100	83122	Catalog 754	85044	Catalog 754
145075	Catalog 754	8-6S	Catalog 100	83123	Catalog 754	85045	Catalog 754
145080	Catalog 754	8-7B	Catalog 100	83124	Catalog 754	85046	Catalog 754
145089	Catalog 754	8-7S	Catalog 100	83125	Catalog 754	85047	Catalog 754
145090	Catalog 754	8-8B	Catalog 100	83126	Catalog 754	85049	Catalog 754
145093	Catalog 754	8-8S	Catalog 100	83127	Catalog 754	85050	Catalog 754
145099	Catalog 754	8-9B	Catalog 100	83128	Catalog 754	85051	Catalog 754
145112	Catalog 754	8-9S	Catalog 100	83130	Catalog 754	85052	Catalog 754
145116	Catalog 754	83001	Catalog 754	83200	Catalog 754	85053	Catalog 754
145123	Catalog 754	83002	Catalog 754	83203	Catalog 754	85054	Catalog 754
145126	Catalog 754	83003	Catalog 754	83204	Catalog 754	85055	Catalog 754
145128	Catalog 754	83004	Catalog 754	83207	Catalog 754	85058	Catalog 754
145132	Catalog 754	83005	Catalog 754	83209	Catalog 754	85059	Catalog 754
145140	Catalog 754	83006	Catalog 754	83214	Catalog 754	85060	Catalog 754

MASTER PART NUMBER INDEX

Part No	Page	Part No	Page	Part No	Page	Part No	Page
G60216	Catalog 754	KIT-4S	Catalog 100	E-632	Catalog 100	E-959	Catalog 100
G60217	Catalog 754	KIT-4SHD	Catalog 100	E-633X	Catalog 100	E-961	Catalog 100
G60218	Catalog 754	KIT-5	Catalog 100	E-634X	Catalog 100	E-975	Catalog 100
G60219	Catalog 754	R3010310	Catalog 700	E-635X	Catalog 100	E-979	Catalog 100
G60221	Catalog 754	R3010311	Catalog 700	E-636X	Catalog 100	E-980	Catalog 100
G60222	Catalog 754	R3010312	Catalog 700	E-640	Catalog 700	E-998X	Catalog 100
G60226	Catalog 754	R3010313	Catalog 700	E-641	Catalog 700	E-999X	Catalog 100
G60232	Catalog 754	R3010314	Catalog 700	E-654	Catalog 100	E-1000	Catalog 100
G60233	Catalog 754	R3010315	Catalog 700	E-656	Catalog 100	E-1001	Catalog 100
G60235	Catalog 754	R3010316	Catalog 700	E-661	Catalog 100	E-1018	Catalog 700
G60237	Catalog 754	R3010317	Catalog 700	E-662	Catalog 100	E-1019	Catalog 700
G60238	Catalog 754	R3010318	Catalog 700	E-667	Catalog 100	E-1020	Catalog 700
G60249	Catalog 754	R3010319	Catalog 700	E-684	Catalog 100	E-1021	Catalog 700
G60250	Catalog 754	RKN28600	Catalog 100	E-685	Catalog 100	E-1023	Catalog 700
G60251	Catalog 754	VIDEO-1F	Catalog 100	E-686	Catalog 100	E-1024	Catalog 700
G60253	Catalog 754	VIDEO-2F	Catalog 100	E-687	Catalog 100	E-1025	Catalog 100
G60255	Catalog 754	E-12S	Catalog 100	E-690	Catalog 100	E-1026	Catalog 100
G60257	Catalog 754	E-16S	Catalog 100	E-691	Catalog 100	E-1038	Catalog 700
G60258	Catalog 754	E-24S	Catalog 100	E-700	Catalog 100	E-1039	Catalog 100
G60259	Catalog 754	E-24S-LS	Catalog 100	E-702	Catalog 100	E-1042	Catalog 100
G60260	Catalog 754	E-30S	Catalog 100	E-712	Catalog 100	E-1046	Catalog 100
G60263	Catalog 754	E-36S	Catalog 100	E-714	Catalog 100	E-1061	Catalog 700
G60264	Catalog 754	E-427K	Catalog 100	E-719	Catalog 100	E-1063HD	Catalog 100
G60265	Catalog 754	E-500	Catalog 100	E-747	Catalog 100	E-1072	Catalog 700
G60269	Catalog 754	E-501	Catalog 100	E-752	Catalog 100	E-1073	Catalog 700
G60301	Catalog 754	E-502	Catalog 100	E-757	Catalog 100	E-1074	Catalog 700
G60302	Catalog 754	E-503	Catalog 100	E-759	Catalog 100	E-1075	Catalog 700
G60303	Catalog 754	E-504	Catalog 100	E-773	Catalog 100	E-1087	Catalog 100
G60304	Catalog 754	E-505	Catalog 100	E-781	Catalog 100	E-1089	Catalog 100
G60305	Catalog 754	E-512	Catalog 100	E-795	Catalog 100	E-1090	Catalog 100
G60306	Catalog 754	E-523	Catalog 100	E-796	Catalog 100	E-1094	Catalog 100
G60307	Catalog 754	E-526	Catalog 100	E-797X	Catalog 100	E-1095	Catalog 100
G60308	Catalog 754	E-527	Catalog 100	E-798X	Catalog 100	E-1106	Catalog 100
G60309	Catalog 754	E-530	Catalog 100	E-801	Catalog 100	E-1107	Catalog 100
G60310	Catalog 754	E-535	Catalog 100	E-807	Catalog 100	E-1108	Catalog 100
G60312	Catalog 754	E-536	Catalog 100	E-813	Catalog 700	E-1112	Catalog 100
G60313	Catalog 754	E-537	Catalog 100	E-844	Catalog 100	E-1112A	Catalog 100
G60329	Catalog 754	E-538	Catalog 100	E-864	Catalog 100	E-1112S	Catalog 100
G60330	Catalog 754	E-539	Catalog 100	E-886	Catalog 100	E-1113	Catalog 100
G60338	Catalog 754	E-540	Catalog 100	E-898	Catalog 700	E-1115	Catalog 100
G61112	Catalog 754	E-541	Catalog 100	E-900	Catalog 700	E-1116	Catalog 100
G61113	Catalog 754	E-543	Catalog 100	E-901	Catalog 700	E-1128	Catalog 100
G61114	Catalog 754	E-544	Catalog 100	E-905	Catalog 700	E-1136	Catalog 100
G61115	Catalog 754	E-556	Catalog 100	E-907	Catalog 700	E-1137	Catalog 100
G61116	Catalog 754	E-557	Catalog 100	E-910	Catalog 100	E-1139	Catalog 100
G61118	Catalog 754	E-563	Catalog 100	E-911X	Catalog 100	E-1140	Catalog 100
G61121	Catalog 754	E-564	Catalog 100	E-912X	Catalog 100	E-1159	Catalog 700
G61122	Catalog 754	E-572	Catalog 100	E-914X	Catalog 100	E-1160	Catalog 700
G61124	Catalog 754	E-573	Catalog 100	E-915X	Catalog 100	E-1166	Catalog 700
G61139	Catalog 754	E-576	Catalog 100	E-916X	Catalog 100	E-1204	Catalog 700
G61144	Catalog 754	E-580	Catalog 100	E-917X	Catalog 100	E-1212SB300R	Catalog 100
G61148	Catalog 754	E-581	Catalog 100	E-918X	Catalog 100	E-1214	Catalog 100
G61149	Catalog 754	E-586	Catalog 100	E-919	Catalog 100	E-1215	Catalog 100
G61150	Catalog 754	E-595	Catalog 100	E-920	Catalog 100	E-1216	Catalog 100
G61151	Catalog 754	E-602	Catalog 100	E-920S	Catalog 100	E-1216SB300R	Catalog 100
G61152	Catalog 754	E-603	Catalog 100	E-927	Catalog 700	E-1217	Catalog 100
G61153	Catalog 754	E-604	Catalog 100	E-934	Catalog 700	E-1218	Catalog 100
G61154	Catalog 754	E-612S	Catalog 100	E-937	Catalog 700	E-1230	Catalog 100
G61155	Catalog 754	E-617	Catalog 100	E-939	Catalog 100	E-1250	Catalog 100
G61156	Catalog 754	E-618	Catalog 100	E-940-BK	Catalog 100	E-1251	Catalog 100
G61158	Catalog 754	E-619	Catalog 100	E-940HD	Catalog 100	E-1252	Catalog 100
G61159	Catalog 754	E-620	Catalog 100	E-940S	Catalog 100	E-1253	Catalog 100
KIT-1	Catalog 100	E-628X	Catalog 100	E-943	Catalog 100	E-1261	Catalog 100
KIT-4HD	Catalog 100	E-631	Catalog 100	E-957	Catalog 100	E-1262	Catalog 100

MASTER PART NUMBER INDEX

Part No	Page	Part No	Page	Part No	Page	Part No	Page
E-1269	Catalog 100	E-1553	Catalog 700	E-1855	Catalog 700	E-1966	Catalog 700
E-1271	Catalog 100	E-1559	Catalog 100	E-1856	Catalog 700	E-1967	Catalog 700
E-1272	Catalog 100	E-1561	Catalog 100	E-1859	Catalog 700	E-1968	Catalog 700
E-1277	Catalog 700	E-1563	Catalog 100	E-1860	Catalog 700	E-1969	Catalog 700
E-1279	Catalog 700	E-1564	Catalog 100	E-1869	Catalog 700	E-1970	Catalog 700
E-12SD300R	Catalog 100	E-1565	Catalog 100	E-1876	Catalog 700	E-1971	Catalog 700
E-1307	Catalog 100	E-1567	Catalog 100	E-1877	Catalog 700	E-1972	Catalog 700
E-1308	Catalog 100	E-1569	Catalog 100	E-1878	Catalog 700	E-1974	Catalog 700
E-1312A	Catalog 700	E-1571	Catalog 100	E-1879	Catalog 700	E-1975	Catalog 700
E-1313	Catalog 700	E-1574-BK	Catalog 100	E-1880B	Catalog 100	E-1980	Catalog 700
E-1314	Catalog 100	E-1574HD	Catalog 100	E-1880S	Catalog 100	E-1981	Catalog 700
E-1318A	Catalog 100	E-1574S	Catalog 100	E-1887AHD	Catalog 100	E-1982	Catalog 700
E-1318AHD	Catalog 100	E-1577A	Catalog 100	E-1887ASHD	Catalog 100	E-1983	Catalog 700
E-1319A	Catalog 100	E-1580	Catalog 100	E-1893	Catalog 100	E-1984	Catalog 700
E-1330	Catalog 700	E-1581	Catalog 100	E-1893S	Catalog 100	E-1986A	Catalog 700
E-1331	Catalog 700	E-1582	Catalog 100	E-1901	Catalog 100	E-1987	Catalog 700
E-1332	Catalog 700	E-1583	Catalog 100	E-1902	Catalog 100	E-1988A	Catalog 700
E-1333	Catalog 700	E-1594	Catalog 700	E-1903	Catalog 100	E-1989	Catalog 700
E-1334	Catalog 700	E-1594-2	Catalog 700	E-1904	Catalog 100	E-1993	Catalog 700
E-1335	Catalog 700	E-1595	Catalog 700	E-1905	Catalog 100	E-1995	Catalog 700
E-1336	Catalog 700	E-1595-2	Catalog 700	E-1906	Catalog 100	E-1996	Catalog 700
E-1337	Catalog 100	E-1597A	Catalog 100	E-1907	Catalog 100	E-1997	Catalog 700
E-1338	Catalog 700	E-1598A	Catalog 700	E-1908	Catalog 100	E-1998A	Catalog 700
E-1339	Catalog 700	E-1600	Catalog 100	E-1909	Catalog 100	E-1999A	Catalog 700
E-1340	Catalog 700	E-1607HD	Catalog 100	E-1910	Catalog 100	E-2000	Catalog 700
E-1341A	Catalog 700	E-1735	Catalog 100	E-1911	Catalog 100	E-2001	Catalog 700
E-1351	Catalog 700	E-1773C	Catalog 100	E-1912	Catalog 100	E-2002	Catalog 700
E-1352	Catalog 700	E-1774C	Catalog 100	E-1913	Catalog 100	E-2003	Catalog 700
E-1353	Catalog 700	E-1775	Catalog 100	E-1914	Catalog 100	E-2004	Catalog 700
E-1354	Catalog 700	E-1776	Catalog 100	E-1915	Catalog 100	E-2005	Catalog 700
E-1357A	Catalog 100	E-1777	Catalog 100	E-1916	Catalog 100	E-2007	Catalog 700
E-1362	Catalog 100	E-1778	Catalog 100	E-1917	Catalog 100	E-2011	Catalog 700
E-1385	Catalog 100	E-1778-SBK5	Catalog 100	E-1918	Catalog 100	E-2015	Catalog 100
E-1393	Catalog 100	E-1778-SBK6	Catalog 100	E-1919	Catalog 100	E-2017	Catalog 700
E-1394	Catalog 100	E-1781	Catalog 100	E-1920	Catalog 100	E-2018	Catalog 700
E-1398	Catalog 100	E-1782	Catalog 100	E-1921	Catalog 100	E-2021	Catalog 700
E-1400	Catalog 100	E-1788	Catalog 100	E-1922	Catalog 100	E-2022	Catalog 700
E-1406	Catalog 100	E-1789	Catalog 100	E-1923	Catalog 100	E-2024	Catalog 700
E-1408	Catalog 100	E-1808	Catalog 100	E-1924	Catalog 100	E-2029	Catalog 100
E-1410	Catalog 100	E-1812	Catalog 100	E-1925	Catalog 100	E-2030HD	Catalog 100
E-1411	Catalog 100	E-1816HD	Catalog 100	E-1926	Catalog 100	E-2031A	Catalog 700
E-1412A	Catalog 100	E-1816HDMB	Catalog 100	E-1927	Catalog 100	E-2034	Catalog 700
E-1413A	Catalog 100	E-1816S	Catalog 100	E-1928	Catalog 100	E-2035	Catalog 700
E-1416	Catalog 100	E-1816SHD	Catalog 100	E-1929	Catalog 100	E-2079	Catalog 700
E-1416A	Catalog 100	E-1817	Catalog 700	E-1930	Catalog 100	E-2086B	Catalog 100
E-1418	Catalog 100	E-1818	Catalog 700	E-1931	Catalog 100	E-2086B-2	Catalog 100
E-1420	Catalog 100	E-1819	Catalog 700	E-1932	Catalog 100	E-2087	Catalog 100
E-1421	Catalog 100	E-1820	Catalog 700	E-1933	Catalog 100	E-2087-2	Catalog 100
E-1422	Catalog 100	E-1821	Catalog 700	E-1934	Catalog 100	E-2088A	Catalog 100
E-1423	Catalog 100	E-1828	Catalog 700	E-1935	Catalog 100	E-2088AHD	Catalog 100
E-1424A	Catalog 100	E-1829	Catalog 700	E-1936	Catalog 100	E-2088AHD-2	Catalog 100
E-1425A	Catalog 100	E-1830	Catalog 700	E-1937	Catalog 100	E-2089	Catalog 100
E-1426	Catalog 100	E-1832	Catalog 700	E-1940	Catalog 700	E-2090	Catalog 100
E-1428A	Catalog 100	E-1833A	Catalog 700	E-1941	Catalog 700	E-2090-2	Catalog 100
E-1428S	Catalog 100	E-1834	Catalog 700	E-1942	Catalog 700	E-2091	Catalog 100
E-1458	Catalog 100	E-1835	Catalog 700	E-1943	Catalog 700	E-2096	Catalog 100
E-1493	Catalog 200	E-1840	Catalog 700	E-1944	Catalog 700	E-2098	Catalog 100
E-1495	Catalog 200	E-1842	Catalog 700	E-1945	Catalog 700	E-2099	Catalog 100
E-1496	Catalog 100	E-1849	Catalog 700	E-1946	Catalog 700	E-20S	Catalog 100
E-1497	Catalog 100	E-1850	Catalog 700	E-1947	Catalog 700	E-2100	Catalog 100
E-1545	Catalog 700	E-1851	Catalog 700	E-1960	Catalog 700	E-2101	Catalog 100
E-1546	Catalog 700	E-1852	Catalog 700	E-1963	Catalog 700	E-2102	Catalog 100
E-1551	Catalog 700	E-1853	Catalog 700	E-1964	Catalog 700	E-2103	Catalog 100
E-1552	Catalog 700	E-1854	Catalog 700	E-1965	Catalog 700	E-2104	Catalog 100

MASTER PART NUMBER INDEX

Part No	Page	Part No	Page	Part No	Page	Part No	Page
E-2106	Catalog 100	E-2281	Catalog 100	E-2421	Catalog 100	E-2518A	Catalog 100
E-2107	Catalog 100	E-2282	Catalog 100	E-2422	Catalog 100	E-2522	Catalog 100
E-2108	Catalog 100	E-2286	Catalog 100	E-2423	Catalog 100	E-2526	Catalog 100
E-2109	Catalog 100	E-2287	Catalog 100	E-2424	Catalog 100	E-2528	Catalog 200
E-2111A	Catalog 100	E-2287-2	Catalog 100	E-2425	Catalog 100	E-2529	Catalog 200
E-2116A	Catalog 700	E-2290	Catalog 100	E-2431	Catalog 100	E-2545	Catalog 700
E-2118	Catalog 700	E-2291	Catalog 100	E-2432	Catalog 100	E-2546	Catalog 700
E-2119	Catalog 100	E-2292	Catalog 700	E-2433	Catalog 100	E-2547	Catalog 700
E-2121	Catalog 100	E-2293	Catalog 700	E-2434	Catalog 100	E-2548	Catalog 700
E-2121HD	Catalog 100	E-2294	Catalog 700	E-2435	Catalog 100	E-2549	Catalog 200
E-2121S	Catalog 100	E-2295	Catalog 700	E-2436	Catalog 100	E-2550	Catalog 100
E-2121SHD	Catalog 100	E-2296	Catalog 100	E-2437	Catalog 100	E-2551	Catalog 100
E-2122	Catalog 100	E-2297	Catalog 100	E-2438	Catalog 100	E-2552	Catalog 100
E-2122-2	Catalog 100	E-2298	Catalog 100	E-2441B	Catalog 100	E-2553	Catalog 700
E-2123	Catalog 100	E-2299	Catalog 100	E-2442B	Catalog 100	E-2554	Catalog 700
E-2125	Catalog 100	E-2300	Catalog 100	E-2443B	Catalog 100	E-2555	Catalog 700
E-2125-2	Catalog 100	E-2301	Catalog 100	E-2444B	Catalog 100	E-2556	Catalog 700
E-2126	Catalog 100	E-2303	Catalog 100	E-2445B	Catalog 100	E-2557	Catalog 700
E-2128	Catalog 100	E-2304	Catalog 100	E-2446B	Catalog 100	E-2558	Catalog 700
E-2130	Catalog 100	E-2305	Catalog 100	E-2447A	Catalog 100	E-2566	Catalog 700
E-2134	Catalog 100	E-2306	Catalog 100	E-2448A	Catalog 100	E-2567	Catalog 700
E-2135	Catalog 100	E-2307	Catalog 100	E-2449A	Catalog 100	E-2570	Catalog 700
E-2136	Catalog 100	E-2340	Catalog 100	E-2450A	Catalog 100	E-2573	Catalog 700
E-2137	Catalog 100	E-2341	Catalog 100	E-2451A	Catalog 100	E-2598A	Catalog 700
E-2138	Catalog 100	E-2358	Catalog 100	E-2452A	Catalog 100	E-2599A	Catalog 700
E-2139	Catalog 100	E-2359	Catalog 100	E-2453A	Catalog 100	E-2600A	Catalog 700
E-2140	Catalog 100	E-2360	Catalog 100	E-2458-BK	Catalog 100	E-2601A	Catalog 700
E-2141	Catalog 100	E-2361	Catalog 100	E-2458HD	Catalog 100	E-2604	Catalog 700
E-2142	Catalog 100	E-2363	Catalog 100	E-2458S	Catalog 100	E-2605	Catalog 700
E-2144	Catalog 100	E-2365	Catalog 100	E-2459-BK	Catalog 100	E-2607	Catalog 700
E-2153	Catalog 100	E-2372	Catalog 700	E-2459HD	Catalog 100	E-2608	Catalog 700
E-2154	Catalog 100	E-2373	Catalog 700	E-2459S	Catalog 100	E-2609	Catalog 700
E-2155	Catalog 100	E-2374	Catalog 700	E-2460	Catalog 100	E-2610	Catalog 700
E-2156	Catalog 100	E-2375	Catalog 700	E-2461	Catalog 100	E-2611	Catalog 700
E-2157	Catalog 100	E-2380	Catalog 100	E-2462	Catalog 100	E-2612	Catalog 700
E-2158	Catalog 100	E-2382	Catalog 100	E-2463	Catalog 100	E-2615	Catalog 700
E-2159	Catalog 100	E-2389	Catalog 100	E-2464	Catalog 100	E-2620	Catalog 700
E-2161	Catalog 100	E-2390	Catalog 100	E-2465	Catalog 100	E-2621	Catalog 700
E-2162	Catalog 100	E-2391	Catalog 100	E-2467	Catalog 100	E-2625	Catalog 700
E-2163	Catalog 100	E-2392	Catalog 100	E-2468	Catalog 100	E-2634	Catalog 700
E-2176	Catalog 100	E-2393	Catalog 100	E-2469	Catalog 100	E-2644	Catalog 100
E-2177	Catalog 100	E-2393A	Catalog 100	E-2469-2	Catalog 100	E-2652	Catalog 100
E-2193	Catalog 100	E-2394	Catalog 100	E-2474	Catalog 100	E-2653A	Catalog 100
E-2208	Catalog 100	E-2394A	Catalog 100	E-2475	Catalog 100	E-2654	Catalog 100
E-2214	Catalog 100	E-2395	Catalog 100	E-2476	Catalog 100	E-2655	Catalog 100
E-2215	Catalog 100	E-2396	Catalog 100	E-2477B	Catalog 100	E-2656	Catalog 100
E-2217A	Catalog 100	E-2398	Catalog 100	E-2478B	Catalog 100	E-2658	Catalog 100
E-2217S	Catalog 100	E-2399	Catalog 100	E-2479B	Catalog 100	E-2659	Catalog 100
E-2218	Catalog 100	E-2401	Catalog 100	E-2484	Catalog 100	E-2660	Catalog 100
E-2225	Catalog 700	E-2402HD	Catalog 100	E-2492	Catalog 100	E-2662	Catalog 100
E-2226	Catalog 700	E-2403HD	Catalog 100	E-2493	Catalog 100	E-2663	Catalog 100
E-2227	Catalog 700	E-2404	Catalog 100	E-2494	Catalog 100	E-2665	Catalog 100
E-2228	Catalog 700	E-2405	Catalog 100	E-2496	Catalog 100	E-2668	Catalog 100
E-2229	Catalog 700	E-2406	Catalog 100	E-2498	Catalog 200	E-2669	Catalog 100
E-2232	Catalog 700	E-2407	Catalog 100	E-2499	Catalog 200	E-2670	Catalog 100
E-2233	Catalog 700	E-2408	Catalog 100	E-2500	Catalog 200	E-2672	Catalog 100
E-2237	Catalog 100	E-2409	Catalog 100	E-2501	Catalog 200	E-2675HD	Catalog 100
E-2238	Catalog 700	E-2411A	Catalog 100	E-2510	Catalog 700	E-2676	Catalog 100
E-2241	Catalog 100	E-2412A	Catalog 100	E-2511	Catalog 700	E-2679A	Catalog 100
E-2272	Catalog 700	E-2413A	Catalog 100	E-2512	Catalog 700	E-2679AHD	Catalog 100
E-2273	Catalog 700	E-2417	Catalog 100	E-2513	Catalog 700	E-2680	Catalog 100
E-2274	Catalog 700	E-2418	Catalog 100	E-2514	Catalog 700	E-2680-2	Catalog 100
E-2275	Catalog 700	E-2419	Catalog 100	E-2515	Catalog 700	E-2681A	Catalog 100
E-2277	Catalog 100	E-2420	Catalog 100	E-2517	Catalog 100	E-2684	Catalog 100

MASTER PART NUMBER INDEX

Part No	Page	Part No	Page	Part No	Page	Part No	Page
E-2685	Catalog 100	E-2799	Catalog 100	E-2889	Catalog 700	E-3016	Catalog 700
E-2686	Catalog 100	E-2800	Catalog 100	E-2890	Catalog 700	E-3031	Catalog 700
E-2687	Catalog 100	E-2801	Catalog 100	E-2891	Catalog 700	E-3079	Catalog 700
E-2689	Catalog 100	E-2802	Catalog 100	E-2892	Catalog 700	E-3080	Catalog 700
E-2690A	Catalog 100	E-2803	Catalog 100	E-2898	Catalog 700	E-3081	Catalog 700
E-2693	Catalog 100	E-2804	Catalog 100	E-2899	Catalog 700	E-3082	Catalog 700
E-2694	Catalog 100	E-2805	Catalog 100	E-2907A	Catalog 700	E-3083A	Catalog 700
E-2695	Catalog 100	E-2807	Catalog 100	E-2908	Catalog 700	E-3085A	Catalog 700
E-2696A	Catalog 100	E-2814	Catalog 700	E-2909	Catalog 700	E-3086	Catalog 700
E-2696A-2	Catalog 100	E-2815	Catalog 700	E-2910A	Catalog 700	E-3087	Catalog 700
E-2700B	Catalog 100	E-2816	Catalog 700	E-2911	Catalog 700	E-3165	Catalog 700
E-2701B	Catalog 100	E-2819	Catalog 100	E-2912A	Catalog 700	E-3166	Catalog 700
E-2709	Catalog 100	E-2820	Catalog 100	E-2913A	Catalog 700	E-3167	Catalog 700
E-2712	Catalog 100	E-2821	Catalog 100	E-2914	Catalog 700	E-3168	Catalog 700
E-2713	Catalog 100	E-2822	Catalog 700	E-2915A	Catalog 700	E-3169	Catalog 700
E-2714A	Catalog 100	E-2823	Catalog 700	E-2916	Catalog 700	E-3170	Catalog 700
E-2715A	Catalog 100	E-2824	Catalog 700	E-2917	Catalog 700	E-3171	Catalog 700
E-2717	Catalog 100	E-2826	Catalog 700	E-2919	Catalog 700	E-3172	Catalog 700
E-2720	Catalog 100	E-2827	Catalog 700	E-2920	Catalog 700	E-3173	Catalog 700
E-2723	Catalog 100	E-2828	Catalog 700	E-2921A	Catalog 700	E-3174	Catalog 700
E-2724	Catalog 100	E-2829	Catalog 700	E-2922A	Catalog 700	E-3175	Catalog 700
E-2725	Catalog 100	E-2830	Catalog 700	E-2923A	Catalog 700	E-3176	Catalog 700
E-2726	Catalog 200	E-2831	Catalog 700	E-2924A	Catalog 700	E-3177A	Catalog 700
E-2728	Catalog 100	E-2832	Catalog 700	E-2925	Catalog 700	E-3178	Catalog 700
E-2729	Catalog 100	E-2833	Catalog 700	E-2927	Catalog 700	E-3179A	Catalog 700
E-2733	Catalog 100	E-2836	Catalog 700	E-2934	Catalog 700	E-3180	Catalog 700
E-2735A	Catalog 100	E-2837	Catalog 700	E-2935	Catalog 700	E-3181	Catalog 700
E-2739	Catalog 100	E-2838	Catalog 700	E-2938	Catalog 700	E-3182	Catalog 700
E-2740	Catalog 100	E-2839	Catalog 700	E-2939	Catalog 700	E-3183A	Catalog 700
E-2745	Catalog 100	E-2840	Catalog 700	E-2940	Catalog 700	E-3184	Catalog 700
E-2746	Catalog 100	E-2842	Catalog 700	E-2951	Catalog 700	E-3185	Catalog 700
E-2760	Catalog 100	E-2843	Catalog 700	E-2956	Catalog 700	E-3186	Catalog 700
E-2761	Catalog 100	E-2844	Catalog 700	E-2957	Catalog 700	E-3187	Catalog 700
E-2762	Catalog 100	E-2845	Catalog 700	E-2958	Catalog 700	E-3188	Catalog 700
E-2763	Catalog 100	E-2847	Catalog 700	E-2959	Catalog 700	E-3189	Catalog 700
E-2764	Catalog 100	E-2848	Catalog 700	E-2964	Catalog 700	E-3190	Catalog 700
E-2765	Catalog 100	E-2849	Catalog 700	E-2965	Catalog 700	E-3191	Catalog 700
E-2766	Catalog 100	E-2850	Catalog 700	E-2975	Catalog 700	E-3192	Catalog 700
E-2767	Catalog 100	E-2852	Catalog 700	E-2977A	Catalog 700	E-3193	Catalog 700
E-2768	Catalog 100	E-2853	Catalog 700	E-2978A	Catalog 700	E-3194	Catalog 700
E-2769HD	Catalog 100	E-2854	Catalog 700	E-2979A	Catalog 700	E-3195	Catalog 700
E-2769S	Catalog 100	E-2855	Catalog 700	E-2983	Catalog 700	E-3196	Catalog 700
E-2769S-R	Catalog 100	E-2856	Catalog 700	E-2984A	Catalog 700	E-3197	Catalog 700
E-2769SHD	Catalog 100	E-2858	Catalog 700	E-2985A	Catalog 700	E-3198	Catalog 700
E-2769SHD-R	Catalog 100	E-2859	Catalog 700	E-2988	Catalog 700	E-3199A	Catalog 700
E-2770	Catalog 100	E-2860	Catalog 700	E-2989	Catalog 700	E-3214	Catalog 700
E-2771	Catalog 700	E-2863A	Catalog 700	E-2992A	Catalog 700	E-3224	Catalog 700
E-2773	Catalog 100	E-2865A	Catalog 700	E-2996	Catalog 700	E-3227	Catalog 100
E-2778	Catalog 100	E-2866A	Catalog 700	E-2997	Catalog 700	E-3228	Catalog 100
E-2778-78XL	Catalog 100	E-2867A	Catalog 700	E-2998	Catalog 700	E-3231	Catalog 100
E-2778-SBK4	Catalog 100	E-2873	Catalog 700	E-3000	Catalog 700	E-3234	Catalog 100
E-2778-SBK6	Catalog 100	E-2874	Catalog 700	E-3001	Catalog 700	E-3240	Catalog 700
E-2778-SBK7	Catalog 100	E-2875	Catalog 700	E-3002A	Catalog 700	E-3244	Catalog 700
E-2781	Catalog 700	E-2878	Catalog 700	E-3003	Catalog 700	E-3247	Catalog 700
E-2781A	Catalog 700	E-2879	Catalog 700	E-3004	Catalog 700	E-3258	Catalog 700
E-2785	Catalog 100	E-2880	Catalog 700	E-3005	Catalog 700	E-3276	Catalog 700
E-2786	Catalog 100	E-2881	Catalog 700	E-3006	Catalog 700	E-3277	Catalog 700
E-2787	Catalog 100	E-2882	Catalog 700	E-3007A	Catalog 100	E-3283A	Catalog 700
E-2792	Catalog 100	E-2883	Catalog 700	E-3008	Catalog 100	E-3284A	Catalog 700
E-2793	Catalog 100	E-2884	Catalog 700	E-3009	Catalog 100	E-3291	Catalog 100
E-2794	Catalog 100	E-2885	Catalog 700	E-3010	Catalog 100	E-3294	Catalog 700
E-2795	Catalog 100	E-2886	Catalog 700	E-3012	Catalog 700	E-3295	Catalog 700
E-2796	Catalog 100	E-2887	Catalog 700	E-3013	Catalog 700	E-3296	Catalog 700
E-2797	Catalog 100	E-2888	Catalog 700	E-3015	Catalog 700	E-3297	Catalog 700

MASTER PART NUMBER INDEX

Part No	Page	Part No	Page	Part No	Page	Part No	Page
E-3299	Catalog 700	E-3490S	Catalog 100	E-3583	Catalog 700	E-3727-R	Catalog 100
E-3303	Catalog 100	E-3491	Catalog 100	E-3586	Catalog 700	E-3728-L	Catalog 100
E-3304	Catalog 100	E-3492	Catalog 100	E-3587	Catalog 700	E-3728-R	Catalog 100
E-3353A	Catalog 100	E-3495	Catalog 100	E-3588	Catalog 700	E-3731	Catalog 700
E-3354	Catalog 100	E-3499	Catalog 100	E-3589	Catalog 700	E-3732	Catalog 700
E-3357	Catalog 700	E-3501	Catalog 100	E-3590	Catalog 700	E-3738	Catalog 700
E-3358	Catalog 700	E-3502	Catalog 100	E-3593	Catalog 700	E-3739	Catalog 700
E-3359	Catalog 700	E-3504	Catalog 100	E-3594	Catalog 700	E-3740	Catalog 700
E-3360	Catalog 700	E-3505	Catalog 100	E-3595	Catalog 700	E-3741	Catalog 700
E-3361	Catalog 700	E-3506	Catalog 100	E-3596	Catalog 700	E-3751	Catalog 700
E-3362	Catalog 700	E-3507	Catalog 100	E-3598	Catalog 700	E-3753A	Catalog 700
E-3363	Catalog 700	E-3508	Catalog 100	E-3599	Catalog 700	E-3754A	Catalog 700
E-3371	Catalog 100	E-3509	Catalog 100	E-3601	Catalog 700	E-3755	Catalog 700
E-3372	Catalog 100	E-3510	Catalog 100	E-3603	Catalog 700	E-3760A	Catalog 700
E-3373HD	Catalog 100	E-3511	Catalog 100	E-3604	Catalog 700	E-3761	Catalog 700
E-3374HD	Catalog 100	E-3512	Catalog 100	E-3605	Catalog 700	E-3762	Catalog 700
E-3379	Catalog 100	E-3513	Catalog 100	E-3606	Catalog 700	E-3763	Catalog 700
E-3380	Catalog 700	E-3515	Catalog 200	E-3635	Catalog 200	E-3764	Catalog 700
E-3381	Catalog 700	E-3516	Catalog 100	E-3636	Catalog 200	E-3768	Catalog 700
E-3382	Catalog 700	E-3517	Catalog 100	E-3653	Catalog 200	E-3771	Catalog 700
E-3383	Catalog 700	E-3518	Catalog 100	E-3659	Catalog 200	E-3773	Catalog 700
E-3384	Catalog 700	E-3520A	Catalog 100	E-3660	Catalog 200	E-3774A	Catalog 700
E-3385	Catalog 700	E-3520A-2	Catalog 100	E-3661	Catalog 200	E-3775	Catalog 100
E-3386A	Catalog 700	E-3520AHD	Catalog 100	E-3662	Catalog 200	E-3777	Catalog 700
E-3390	Catalog 700	E-3520AHD-2	Catalog 100	E-3669	Catalog 200	E-3779	Catalog 700
E-3391	Catalog 700	E-3522	Catalog 100	E-3670	Catalog 200	E-3781	Catalog 100
E-3392	Catalog 700	E-3523	Catalog 100	E-3677	Catalog 700	E-3782	Catalog 100
E-3393	Catalog 700	E-3524	Catalog 100	E-3679	Catalog 700	E-3783	Catalog 700
E-3394A	Catalog 700	E-3525	Catalog 100	E-3680	Catalog 700	E-3784	Catalog 700
E-3398	Catalog 700	E-3527	Catalog 700	E-3683	Catalog 700	E-3785	Catalog 700
E-3409	Catalog 700	E-3528	Catalog 700	E-3685	Catalog 700	E-3786	Catalog 700
E-3410	Catalog 700	E-3529	Catalog 700	E-3687	Catalog 700	E-3787	Catalog 700
E-3411	Catalog 700	E-3530	Catalog 700	E-3688	Catalog 700	E-3788	Catalog 700
E-3414	Catalog 700	E-3531	Catalog 700	E-3689	Catalog 700	E-3789	Catalog 700
E-3415	Catalog 700	E-3532	Catalog 700	E-3690	Catalog 700	E-3790	Catalog 700
E-3416	Catalog 700	E-3533	Catalog 700	E-3691	Catalog 700	E-3792	Catalog 700
E-3417	Catalog 100	E-3534	Catalog 700	E-3692	Catalog 700	E-3793	Catalog 700
E-3421A	Catalog 100	E-3536	Catalog 700	E-3693	Catalog 700	E-3794	Catalog 700
E-3427	Catalog 100	E-3537A	Catalog 700	E-3696	Catalog 700	E-3795	Catalog 700
E-3437	Catalog 100	E-3538	Catalog 700	E-3697	Catalog 700	E-3796	Catalog 700
E-3438	Catalog 100	E-3539	Catalog 700	E-3698	Catalog 700	E-3797	Catalog 700
E-3439	Catalog 100	E-3540A	Catalog 700	E-3699	Catalog 700	E-3798	Catalog 700
E-3441	Catalog 100	E-3541	Catalog 700	E-3700	Catalog 700	E-3799	Catalog 700
E-3445	Catalog 100	E-3542	Catalog 700	E-3701	Catalog 700	E-3801	Catalog 100
E-3446	Catalog 100	E-3546	Catalog 700	E-3702	Catalog 700	E-3816	Catalog 700
E-3446-2	Catalog 100	E-3555	Catalog 700	E-3703	Catalog 700	E-3817	Catalog 700
E-3447	Catalog 100	E-3556	Catalog 700	E-3704	Catalog 700	E-3818	Catalog 700
E-3460	Catalog 100	E-3557	Catalog 700	E-3706	Catalog 700	E-3819	Catalog 700
E-3461	Catalog 100	E-3560	Catalog 700	E-3710HD	Catalog 100	E-3821A	Catalog 700
E-3468A	Catalog 100	E-3561A	Catalog 700	E-3710S	Catalog 100	E-3823	Catalog 100
E-3469	Catalog 100	E-3562	Catalog 700	E-3710SHD	Catalog 100	E-3824	Catalog 100
E-3471	Catalog 100	E-3563	Catalog 700	E-3711	Catalog 100	E-3828	Catalog 700
E-3472	Catalog 100	E-3564	Catalog 700	E-3711S	Catalog 100	E-3829	Catalog 700
E-3473	Catalog 100	E-3565	Catalog 700	E-3713	Catalog 100	E-3839	Catalog 700
E-3475	Catalog 100	E-3567	Catalog 700	E-3714	Catalog 100	E-3844	Catalog 700
E-3476	Catalog 100	E-3568	Catalog 700	E-3715	Catalog 700	E-3845	Catalog 700
E-3477	Catalog 100	E-3569	Catalog 700	E-3717	Catalog 700	E-3846	Catalog 700
E-3478	Catalog 100	E-3576	Catalog 700	E-3720	Catalog 700	E-3849	Catalog 700
E-3479	Catalog 100	E-3577	Catalog 700	E-3722	Catalog 700	E-3852	Catalog 700
E-3481A	Catalog 100	E-3578	Catalog 700	E-3723-L	Catalog 100	E-3854	Catalog 100
E-3482	Catalog 100	E-3579	Catalog 700	E-3723-R	Catalog 100	E-3855	Catalog 100
E-3483	Catalog 100	E-3580	Catalog 700	E-3724-L	Catalog 100	E-3856	Catalog 100
E-3484	Catalog 100	E-3581	Catalog 700	E-3724-R	Catalog 100	E-3857	Catalog 100
E-3490B	Catalog 100	E-3582	Catalog 700	E-3727-L	Catalog 100	E-3858	Catalog 100

MASTER PART NUMBER INDEX

Part No	Page	Part No	Page	Part No	Page	Part No	Page
E-3859	Catalog 100	E-3999	Catalog 100	E-4093	Catalog 200	E-4196	Catalog 200
E-3861	Catalog 100	E-4004	Catalog 200	E-4094	Catalog 200	E-4197	Catalog 200
E-3862	Catalog 100	E-4009	Catalog 200	E-4095	Catalog 200	E-4198	Catalog 200
E-3864B	Catalog 100	E-4010	Catalog 200	E-4096	Catalog 200	E-4199	Catalog 200
E-3865	Catalog 100	E-4013	Catalog 200	E-4097	Catalog 200	E-4200	Catalog 200
E-3867	Catalog 700	E-4014	Catalog 200	E-4100	Catalog 200	E-4201	Catalog 200
E-3868	Catalog 700	E-4015	Catalog 200	E-4101	Catalog 200	E-4202	Catalog 200
E-3869	Catalog 100	E-4016	Catalog 200	E-4102	Catalog 200	E-4203	Catalog 200
E-3871	Catalog 100	E-4018	Catalog 200	E-4103	Catalog 200	E-4204	Catalog 200
E-3872	Catalog 100	E-4018-MB23	Catalog 200	E-4104	Catalog 200	E-4205	Catalog 200
E-3873	Catalog 100	E-4019	Catalog 200	E-4105	Catalog 200	E-4206	Catalog 200
E-3874	Catalog 100	E-4019-MB23	Catalog 200	E-4106	Catalog 200	E-4207	Catalog 200
E-3876	Catalog 100	E-4020	Catalog 200	E-4107	Catalog 200	E-4209	Catalog 200
E-3876-2	Catalog 100	E-4020-MB23	Catalog 200	E-4108	Catalog 200	E-4210	Catalog 200
E-3877	Catalog 100	E-4022	Catalog 200	E-4110	Catalog 200	E-4211	Catalog 200
E-3878	Catalog 100	E-4023	Catalog 200	E-4111	Catalog 200	E-4212	Catalog 200
E-3881	Catalog 700	E-4024	Catalog 200	E-4112	Catalog 200	E-4217	Catalog 200
E-3882	Catalog 700	E-4025	Catalog 200	E-4113	Catalog 200	E-4218	Catalog 200
E-3883	Catalog 200	E-4026	Catalog 200	E-4114	Catalog 200	E-4225	Catalog 200
E-3884	Catalog 200	E-4027	Catalog 200	E-4115	Catalog 200	E-4226	Catalog 200
E-3885	Catalog 200	E-4028	Catalog 200	E-4116A	Catalog 200	E-4227	Catalog 200
E-3886	Catalog 200	E-4029	Catalog 200	E-4117A	Catalog 200	E-4228	Catalog 200
E-3888	Catalog 200	E-4030	Catalog 200	E-4118	Catalog 200	E-4229	Catalog 200
E-3889	Catalog 200	E-4032	Catalog 200	E-4119	Catalog 200	E-4230	Catalog 200
E-3890	Catalog 200	E-4033	Catalog 200	E-4120	Catalog 200	E-4231	Catalog 200
E-3891	Catalog 200	E-4034	Catalog 200	E-4121	Catalog 200	E-4232	Catalog 200
E-3892	Catalog 200	E-4035	Catalog 200	E-4122	Catalog 200	E-4233	Catalog 200
E-3893	Catalog 200	E-4038	Catalog 200	E-4123	Catalog 200	E-4234	Catalog 200
E-3894	Catalog 200	E-4042	Catalog 200	E-4124	Catalog 200	E-4235	Catalog 200
E-3895S	Catalog 100	E-4044	Catalog 200	E-4125	Catalog 200	E-4235X	Catalog 200
E-3895S-R	Catalog 100	E-4050	Catalog 200	E-4126	Catalog 200	E-4236	Catalog 200
E-3895SHD	Catalog 100	E-4051	Catalog 200	E-4127	Catalog 200	E-4236X	Catalog 200
E-3895SHD-R	Catalog 100	E-4052	Catalog 200	E-4128	Catalog 200	E-4237A	Catalog 200
E-3900	Catalog 700	E-4053	Catalog 200	E-4129	Catalog 200	E-4237AX	Catalog 200
E-3909	Catalog 100	E-4056	Catalog 200	E-4130	Catalog 200	E-4238	Catalog 200
E-3910	Catalog 100	E-4057	Catalog 200	E-4131	Catalog 200	E-4238X	Catalog 200
E-3911	Catalog 100	E-4058	Catalog 200	E-4132	Catalog 200	E-4239	Catalog 200
E-3914	Catalog 100	E-4059	Catalog 200	E-4133	Catalog 200	E-4240	Catalog 200
E-3915	Catalog 700	E-4060	Catalog 200	E-4134	Catalog 200	E-4241	Catalog 200
E-3916	Catalog 700	E-4061	Catalog 200	E-4135	Catalog 200	E-4242	Catalog 200
E-3917	Catalog 700	E-4062	Catalog 200	E-4136	Catalog 200	E-4243	Catalog 200
E-3917A	Catalog 700	E-4063	Catalog 200	E-4140	Catalog 200	E-4244X	Catalog 200
E-3919	Catalog 700	E-4064	Catalog 200	E-4141	Catalog 200	E-4245	Catalog 200
E-3920	Catalog 100	E-4065	Catalog 200	E-4142	Catalog 200	E-4245X	Catalog 200
E-3920-SBK10	Catalog 100	E-4066	Catalog 200	E-4143	Catalog 200	E-4246	Catalog 200
E-3972	Catalog 700	E-4067	Catalog 200	E-4144	Catalog 200	E-4247	Catalog 200
E-3975	Catalog 700	E-4068	Catalog 200	E-4145	Catalog 200	E-4252	Catalog 700
E-3976	Catalog 700	E-4069	Catalog 200	E-4147	Catalog 200	E-4253	Catalog 700
E-3977	Catalog 700	E-4070	Catalog 200	E-4148	Catalog 200	E-4254	Catalog 700
E-3978	Catalog 700	E-4071	Catalog 200	E-4149	Catalog 200	E-4255	Catalog 700
E-3979	Catalog 700	E-4072	Catalog 200	E-4150	Catalog 200	E-4256	Catalog 700
E-3987	Catalog 700	E-4073	Catalog 200	E-4151	Catalog 200	E-4257	Catalog 700
E-3988	Catalog 700	E-4074	Catalog 200	E-4152	Catalog 200	E-4258	Catalog 700
E-3989AHD	Catalog 100	E-4077	Catalog 200	E-4175	Catalog 200	E-4261	Catalog 700
E-3989AHD-2	Catalog 100	E-4078	Catalog 200	E-4176	Catalog 200	E-4262	Catalog 700
E-3991	Catalog 100	E-4082	Catalog 200	E-4177	Catalog 200	E-4263	Catalog 700
E-3992	Catalog 100	E-4083	Catalog 200	E-4180	Catalog 200	E-4265	Catalog 700
E-3993B	Catalog 100	E-4086	Catalog 200	E-4182	Catalog 200	E-4266	Catalog 700
E-3993B-2	Catalog 100	E-4087	Catalog 200	E-4183	Catalog 200	E-4267	Catalog 700
E-3994	Catalog 100	E-4088	Catalog 200	E-4184	Catalog 200	E-4268	Catalog 700
E-3995	Catalog 100	E-4089	Catalog 200	E-4185	Catalog 200	E-4273	Catalog 700
E-3996	Catalog 100	E-4090	Catalog 200	E-4193	Catalog 200	E-4274	Catalog 700
E-3997	Catalog 100	E-4091	Catalog 200	E-4194	Catalog 200	E-4275	Catalog 700
E-3998	Catalog 100	E-4092	Catalog 200	E-4195	Catalog 200	E-4277	Catalog 700

MASTER PART NUMBER INDEX

Part No	Page	Part No	Page	Part No	Page	Part No	Page
E-4278	Catalog 700	E-4387	Catalog 700	E-4434N (cont)	11-108,11-112, 11-132,11-134, 11-150,11-174, 11-175,11-190, 11-191	E-4441B (cont)	11-55,11-56, 11-57,11-133, 11-150,11-156, 11-158,11-160
E-4279	Catalog 700	E-4389	Catalog 700	E-4435B	11-4,11-5, 11-64,11-65, 11-66,11-68, 11-71,11-73, 11-74,11-75, 11-76,11-77, 11-79,11-80, 11-81,11-82, 11-83,11-84, 11-85,11-86, 11-87,11-88, 11-89,11-92, 11-93,11-94, 11-95,11-96, 11-97,11-98, 11-99,11-100, 11-101,11-102, 11-103,11-133	E-4442B	11-3,11-5, 11-31,11-35, 11-41,11-44, 11-45,11-49, 11-55,11-56, 11-57,11-60, 11-105,11-106, 11-108,11-112, 11-134,11-150, 11-156,11-157, 11-158,11-160, 11-171,11-174, 11-175,11-190, 11-191
E-4281	Catalog 700	E-4390	Catalog 700	E-4435N	11-4,11-5, 11-64,11-65, 11-66,11-68, 11-71,11-73, 11-74,11-75, 11-76,11-77, 11-79,11-80, 11-81,11-82, 11-83,11-84, 11-85,11-86, 11-87,11-88, 11-89,11-92, 11-93,11-94, 11-95,11-96, 11-97,11-98, 11-99,11-100, 11-101,11-102, 11-103,11-133	E-4443B	11-1,11-5, 11-64,11-65, 11-66,11-68, 11-69,11-70, 11-71,11-73, 11-74,11-75, 11-77,11-79, 11-80,11-81, 11-82,11-85, 11-86,11-87, 11-89,11-90, 11-91,11-92, 11-93,11-94, 11-95,11-96, 11-97,11-98, 11-100,11-102, 11-103
E-4282	Catalog 700	E-4391	Catalog 700	E-4438B	11-1,11-5, 11-25,11-31, 11-36,11-38, 11-39,11-41, 11-56,11-57, 11-132,11-150	E-4443N	11-1,11-5, 11-64,11-65, 11-66,11-68, 11-69,11-70, 11-71,11-73, 11-74,11-75, 11-77,11-79, 11-80,11-81, 11-82,11-85, 11-86,11-87, 11-89,11-90, 11-91,11-92, 11-93,11-94, 11-95,11-96, 11-97,11-98, 11-100,11-102, 11-103
E-4283	Catalog 700	E-4392	Catalog 700	E-4438N	11-1,11-5, 11-25,11-31, 11-36,11-38, 11-39,11-41, 11-56,11-57, 11-132,11-150	E-4444B	11-1,11-5, 11-64,11-69, 11-70,11-71, 11-76,11-77, 11-85,11-86, 11-90,11-91, 11-92,11-93, 11-94,11-95
E-4284	Catalog 700	E-4393	Catalog 700	E-4440B	11-1,11-5, 11-25,11-28, 11-36,11-39, 11-53,11-54, 11-56,11-57	E-4444N	11-1,11-5, 11-64,11-69, 11-70,11-71, 11-76,11-77, 11-85,11-86, 11-90,11-91, 11-92,11-93, 11-94,11-95
E-4285	Catalog 700	E-4394	Catalog 700	E-4441B	11-1,11-5, 11-28,11-31, 11-35,11-38, 11-39,11-41, 11-44,11-45, 11-49,11-54		
E-4286	Catalog 700	E-4396	Catalog 700				
E-4287	Catalog 700	E-4397	Catalog 700				
E-4288	Catalog 700	E-4398A	Catalog 700				
E-4289	Catalog 700	E-4399	Catalog 700				
E-4290	Catalog 700	E-4400	Catalog 700				
E-4291	Catalog 700	E-4401A	Catalog 700				
E-4292	Catalog 700	E-4402	Catalog 700				
E-4293	Catalog 700	E-4403	Catalog 700				
E-4294	Catalog 700	E-4405	Catalog 700				
E-4298	Catalog 700	E-4406	Catalog 700				
E-4299	Catalog 700	E-4409	Catalog 700				
E-4300	Catalog 700	E-4410A	Catalog 700				
E-4301	Catalog 700	E-4411A	Catalog 700				
E-4302	Catalog 700	E-4421	Catalog 700				
E-4303	Catalog 700	E-4429	Catalog 700				
E-4305	Catalog 700	E-4430B	11-1,11-5, 11-70,11-71, 11-89,11-90				
E-4306	Catalog 700						
E-4307	Catalog 700	E-4431B	11-1,11-5, 11-150,11-156, 11-158,11-160, 11-163				
E-4308	Catalog 700						
E-4309	Catalog 700	E-4434B	11-4,11-5, 11-60,11-64, 11-73,11-74, 11-76,11-77, 11-78,11-79, 11-80,11-81, 11-82,11-83, 11-84,11-85, 11-86,11-87, 11-88,11-89, 11-95,11-96, 11-97,11-98, 11-99,11-101, 11-102,11-103, 11-105,11-106, 11-108,11-112, 11-132,11-134, 11-150,11-174, 11-175,11-190, 11-191				
E-4310	Catalog 700						
E-4312	Catalog 700						
E-4313	Catalog 700						
E-4315	Catalog 700						
E-4316	Catalog 700						
E-4317	Catalog 700						
E-4318	Catalog 700						
E-4319	Catalog 700						
E-4321	Catalog 700						
E-4323	Catalog 700						
E-4324	Catalog 700						
E-4325	Catalog 700						
E-4326	Catalog 700						
E-4327	Catalog 700						
E-4328	Catalog 700						
E-4329	Catalog 700						
E-4330A	Catalog 700						
E-4331	Catalog 700						
E-4332	Catalog 700						
E-4333	Catalog 700						
E-4334	Catalog 700						
E-4338	Catalog 700						
E-4339	Catalog 700	E-4434N	11-4,11-5, 11-60,11-64, 11-73,11-74, 11-76,11-77, 11-78,11-79, 11-80,11-81, 11-82,11-83, 11-84,11-85, 11-86,11-87, 11-88,11-89, 11-95,11-96, 11-97,11-98, 11-99,11-101, 11-102,11-103, 11-105,11-106				
E-4342	Catalog 700						
E-4343	Catalog 700						
E-4345	Catalog 700						
E-4347	Catalog 700						
E-4348	Catalog 700						
E-4350	Catalog 700						
E-4358	Catalog 700						
E-4361	Catalog 700						
E-4363	Catalog 700						
E-4364	Catalog 700						
E-4382A	Catalog 700						
E-4383	Catalog 700						
E-4384	Catalog 700						
E-4385	Catalog 700						

MASTER PART NUMBER INDEX

Part No	Page	Part No	Page	Part No	Page	Part No	Page
E-4444N (cont)	11-85,11-86, 11-90,11-91, 11-92,11-93, 11-94,11-95	E-4454B (cont)	11-57,11-60, 11-77,11-79, 11-82,11-83, 11-84,11-88,	E-4458B (cont)	11-185,11-189, 11-190,11-191	E-4468B (cont)	11-60,11-67, 11-94,11-100, 11-105,11-106, 11-108,11-109, 11-110,11-111, 11-112,11-123, 11-135,11-144, 11-148,11-150, 11-153,11-163, 11-165,11-166, 11-167,11-171, 11-174,11-175, 11-180,11-181, 11-182,11-183, 11-189,11-190, 11-191
E-4445B	11-1,11-5, 11-25,11-28, 11-31,11-36, 11-38,11-39, 11-42,11-45, 11-49,11-54, 11-55,11-56		11-101,11-102, 11-105,11-106, 11-108,11-112, 11-115,11-136, 11-137,11-150, 11-151,11-154, 11-156,11-157, 11-158,11-160, 11-162,11-169, 11-170,11-171, 11-174,11-175, 11-190,11-191	E-4458C	11-4,11-5, 11-31,11-45, 11-49,11-50, 11-60,11-67, 11-68,11-77, 11-82,11-84, 11-88,11-100, 11-105,11-106, 11-108,11-109, 11-111,11-112, 11-123,11-137, 11-141,11-142, 11-143,11-144, 11-145,11-146, 11-148,11-150, 11-151,11-153, 11-155,11-156, 11-158,11-161, 11-162,11-163, 11-165,11-167, 11-169,11-171, 11-174,11-175, 11-179,11-182, 11-183,11-185, 11-189,11-190, 11-191	E-4469B	11-2,11-5, 11-65,11-66, 11-67,11-68, 11-71,11-73, 11-74,11-75, 11-77,11-78, 11-79,11-80, 11-81,11-82, 11-83,11-86, 11-87,11-88, 11-91,11-92, 11-94,11-96, 11-97,11-100, 11-102
E-4445N	11-1,11-5, 11-25,11-28, 11-31,11-36, 11-38,11-39, 11-42,11-45, 11-49,11-54, 11-55,11-56	E-4454N	11-4,11-5, 11-45,11-49, 11-50,11-56, 11-57,11-60, 11-77,11-79, 11-82,11-83, 11-84,11-88, 11-101,11-102, 11-105,11-106, 11-108,11-112, 11-115,11-136, 11-137,11-151, 11-154,11-156, 11-157,11-158, 11-160,11-162, 11-169,11-170, 11-171,11-174, 11-175,11-190, 11-191	E-4459B	11-3,11-5, 11-31,11-33, 11-34,11-35, 11-36,11-39, 11-42,11-45, 11-49,11-57	E-4470B	11-3,11-5, 11-187,11-189, 11-192
E-4448B	11-2,11-5, 11-156,11-158, 11-160,11-166		11-191	E-4459C	11-3,11-5, 11-31,11-33, 11-34,11-36, 11-39,11-42, 11-45,11-49	E-4471B	11-3,11-5, 11-187,11-189
E-4449B	11-2,11-5, 11-31,11-35, 11-41,11-44, 11-56,11-57, 11-60,11-77, 11-79,11-105, 11-106,11-108, 11-112,11-134, 11-150,11-154, 11-157,11-158, 11-170,11-171, 11-174,11-175, 11-190,11-191	E-4457B	11-2,11-5, 11-31,11-33, 11-34,11-36, 11-39,11-42, 11-45,11-49	E-4460B	11-1,11-5, 11-20,11-150, 11-156,11-158, 11-160,11-166	E-4513	11-6
E-4450B	11-3,11-5, 11-60,11-105, 11-106,11-108, 11-112,11-135, 11-150,11-157, 11-158,11-160, 11-169,11-171, 11-174,11-175, 11-190,11-191		11-4,11-5, 11-31,11-45, 11-49,11-50, 11-53,11-55, 11-60,11-67, 11-68,11-77, 11-82,11-84, 11-88,11-100, 11-105,11-106, 11-108,11-109, 11-111,11-112, 11-123,11-137, 11-141,11-142, 11-143,11-144, 11-146,11-148, 11-150,11-151, 11-153,11-155, 11-156,11-158, 11-161,11-162, 11-163,11-165, 11-167,11-169, 11-171,11-174, 11-175,11-179, 11-182,11-183,	E-4461B	11-2,11-5, 11-156,11-158, 11-160,11-166	E-4514	11-6
E-4451B	11-2,11-5, 11-155,11-156, 11-157,11-158, 11-160,11-162, 11-163,11-166, 11-167,11-169, 11-170,11-171, 11-187,11-192	E-4458B	11-4,11-5, 11-31,11-45, 11-49,11-50, 11-53,11-55, 11-60,11-67, 11-68,11-77, 11-82,11-84, 11-88,11-100, 11-105,11-106, 11-108,11-109, 11-111,11-112, 11-123,11-137, 11-141,11-142, 11-143,11-144, 11-146,11-148, 11-150,11-151, 11-153,11-155, 11-156,11-158, 11-161,11-162, 11-163,11-165, 11-167,11-169, 11-171,11-174, 11-175,11-179, 11-182,11-183,	E-4462B	11-2,11-5, 11-20,11-153, 11-156,11-158, 11-160,11-162, 11-163,11-164, 11-166,11-169, 11-171	E-4515	11-6
E-4452B	11-1,11-5, 11-25,11-28, 11-31,11-36, 11-38,11-39, 11-42,11-45, 11-49,11-54		11-191	E-4463B	11-2,11-5, 11-20,11-156, 11-158,11-160, 11-163,11-166	E-4516	11-6
E-4453B	11-1,11-5, 11-70,11-71, 11-90,11-91, 11-92,11-94		11-191	E-4467B	11-4,11-5, 11-115,11-116, 11-118,11-120, 11-121,11-122, 11-123,11-124, 11-125,11-127	E-4517	11-6
E-4454B	11-4,11-5, 11-45,11-49, 11-50,11-56,		11-191	E-4468B	11-3,11-5,	E-4518	11-6
						E-4519	11-6
						E-4520	11-6
						E-4521	11-6
						E-4522	11-6
						E-4523	11-6
						E-4524	11-6
						E-4525	11-6
						E-452A	Catalog 100
						E-4531	11-6
						E-4532	11-6
						E-4534	11-6
						E-4536	11-6
						E-4538	11-6
						E-4539	11-6
						E-4540	11-6
						E-4541	11-6
						E-4542	11-6
						E-4543	11-6
						E-4544	11-6
						E-4545	11-6
						E-4546	11-6
						E-4547	11-6
						E-4549	11-6
						E-4550	11-6
						E-4552	11-6
						E-4553	11-6

MASTER PART NUMBER INDEX

Part No	Page	Part No	Page	Part No	Page	Part No	Page
E-4554	11-6	E-4605	11-8,11-20,	E-4609 (cont)	11-98,11-99,	E-4612 (cont)	11-82,11-87,
E-4555	11-6		11-25,11-26,		11-100,11-101,		11-90,11-91,
E-4562	11-6		11-28,11-29,		11-102,11-103		11-92,11-94,
E-4563	11-6		11-32,11-36,	E-4610	11-8,11-32,		11-96,11-98,
E-4564	11-6		11-37,11-39,		11-35,11-37,		11-101,11-102
E-4572	11-7		11-40,11-43,		11-39,11-40,	E-4613	11-8,11-26,
E-4573	11-7		11-46,11-50,		11-42,11-44,		11-28,11-36,
E-4575	11-7		11-53,11-54,		11-46,11-54,		11-40,11-43,
E-4576	11-7		11-55,11-56,		11-55,11-56,		11-65,11-66,
E-4577	11-7		11-57,11-151,		11-57,11-61,		11-69,11-70,
E-4579	11-7		11-156,11-159,		11-78,11-81,		11-71,11-72,
E-4580	11-7		11-160,11-167		11-84,11-88,		11-75,11-80,
E-4581	11-7	E-4606	11-8,11-65,		11-105,11-107,		11-82,11-87,
E-4582	11-7		11-66,11-67,		11-108,11-112,		11-90,11-91,
E-4583	11-7		11-72,11-73,		11-115,11-116,		11-92,11-94,
E-4586	Catalog 100		11-74,11-75,		11-119,11-120,		11-96,11-98,
E-4587	Catalog 100		11-78,11-79,		11-121,11-122,		11-101,11-102
E-4593	Catalog 100		11-81,11-84,		11-124,11-125,	E-4614	11-8,11-20,
E-4594	Catalog 100		11-87,11-88,		11-126,11-127,		11-21,11-23,
E-4595B	11-2,11-5,		11-93,11-94,		11-132,11-133,		11-32,11-33,
	11-60,11-105,		11-95,11-96,		11-134,11-136,		11-34,11-35,
	11-108,11-112,		11-97,11-99,		11-138,11-141,		11-37,11-40,
	11-135,11-146,		11-101,11-102,		11-142,11-143,		11-41,11-43,
	11-148,11-150,		11-103		11-152,11-155,		11-46,11-47,
	11-153,11-171,	E-4607	11-8,11-65,		11-156,11-157,		11-50,11-51,
	11-174,11-175		11-66,11-67,		11-159,11-160,		11-55,11-61,
E-4598B	11-3,11-5		11-72,11-73,		11-161,11-168,		11-67,11-69,
E-4599B	11-4,11-5,		11-74,11-75,		11-170,11-171,		11-95,11-100,
	11-115,11-116,		11-78,11-79,		11-174,11-176,		11-105,11-107,
	11-117,11-118,		11-81,11-84,		11-191,11-192		11-108,11-109,
	11-120,11-121,		11-87,11-88,	E-4611	11-8,11-32,		11-110,11-111,
	11-122,11-124,		11-93,11-94,		11-35,11-37,		11-112,11-124,
	11-125		11-95,11-96,		11-39,11-40,		11-132,11-133,
E-4600	11-8,11-88,		11-97,11-99,		11-42,11-44,		11-135,11-136,
	11-151,11-156,		11-101,11-102,		11-46,11-54,		11-139,11-141,
	11-159,11-160,		11-103,11-115,		11-55,11-56,		11-142,11-143,
	11-164		11-116,11-119,		11-57,11-61,		11-145,11-146,
E-4601	11-8,11-151,		11-121,11-122,		11-78,11-81,		11-147,11-149,
	11-156,11-159,		11-126,11-127		11-84,11-88,		11-152,11-154,
	11-160,11-164	E-4608	11-8,11-65,		11-105,11-107,		11-156,11-157,
E-4602	11-8,11-26,		11-66,11-67,		11-108,11-112,		11-159,11-161,
	11-32,11-37,		11-69,11-72,		11-115,11-116,		11-164,11-165,
	11-39,11-40,		11-73,11-74,		11-119,11-120,		11-168,11-170,
	11-42,11-56,		11-75,11-78,		11-121,11-122,		11-171,11-174,
	11-57,11-132,		11-79,11-80,		11-124,11-125,		11-176,11-179,
	11-133		11-81,11-82,		11-126,11-127,		11-180,11-181,
E-4603	11-8,11-26,		11-83,11-84,		11-132,11-133,		11-182,11-183,
	11-32,11-37,		11-87,11-88,		11-134,11-136,		11-185,11-187,
	11-39,11-40,		11-91,11-92,		11-138,11-141,		11-189,11-190,
	11-42,11-56,		11-95,11-97,		11-142,11-143,		11-191,11-192
	11-57,11-132,		11-98,11-99,		11-152,11-155,	E-4615	11-8,11-20,
	11-133		11-100,11-101,		11-156,11-157,		11-23,11-32,
E-4604	11-8,11-20,		11-102,11-103		11-159,11-160,		11-33,11-34,
	11-25,11-26,	E-4609	11-8,11-65,		11-161,11-168,		11-35,11-37,
	11-28,11-29,		11-66,11-67,		11-170,11-171,		11-40,11-41,
	11-32,11-36,		11-69,11-72,		11-174,11-176,		11-43,11-46,
	11-37,11-39,		11-73,11-74,		11-191,11-192		11-47,11-50,
	11-40,11-43,		11-75,11-78,	E-4612	11-8,11-26,		11-51,11-55,
	11-46,11-50,		11-79,11-80,		11-28,11-36,		11-61,11-67,
	11-53,11-54,		11-81,11-82,		11-40,11-43,		11-69,11-95,
	11-55,11-56,		11-83,11-84,		11-65,11-66,		11-100,11-105,
	11-57,11-151,		11-87,11-88,		11-69,11-70,		11-107,11-108,
	11-156,11-159,		11-91,11-92,		11-71,11-72,		11-109,11-110,
	11-160,11-167		11-95,11-97,		11-75,11-80,		11-111,11-112,

MASTER PART NUMBER INDEX

Part No	Page	Part No	Page	Part No	Page	Part No	Page
E-4615 (cont)	11-124,11-132, 11-133,11-135, 11-136,11-139, 11-141,11-142, 11-143,11-145, 11-146,11-147, 11-149,11-152, 11-154,11-156, 11-157,11-159, 11-161,11-164, 11-165,11-167, 11-168,11-170, 11-171,11-174, 11-176,11-179, 11-180,11-181, 11-182,11-183, 11-185,11-187, 11-189,11-190, 11-191,11-192	E-4617 (cont)	11-113,11-115, 11-116,11-117, 11-118,11-119, 11-120,11-121, 11-122,11-123, 11-124,11-125, 11-126,11-127, 11-132,11-134, 11-135,11-136, 11-137,11-142, 11-152,11-155, 11-156,11-157, 11-159,11-161, 11-162,11-170, 11-171,11-174, 11-176,11-177, 11-179,11-180, 11-182,11-183, 11-185,11-187, 11-189,11-190, 11-191,11-192	E-4622 (cont)	11-46,11-50, 11-54,11-55	E-4628 (cont)	11-185,11-189, 11-191,11-192
E-4616	11-9,11-21, 11-32,11-47, 11-50,11-51, 11-58,11-61, 11-62,11-78, 11-80,11-82, 11-83,11-84, 11-88,11-101, 11-102,11-105, 11-106,11-107, 11-108,11-110, 11-111,11-112, 11-113,11-115, 11-116,11-117, 11-118,11-119, 11-120,11-121, 11-122,11-123, 11-124,11-125, 11-126,11-127, 11-132,11-134, 11-135,11-136, 11-137,11-142, 11-152,11-155, 11-156,11-157, 11-159,11-161, 11-162,11-170, 11-171,11-174, 11-176,11-177, 11-179,11-180, 11-182,11-183, 11-185,11-187, 11-189,11-190, 11-191,11-192	E-4618	11-9,11-32, 11-35,11-42, 11-44,11-56, 11-57,11-58, 11-61,11-105, 11-107,11-108, 11-112,11-134, 11-174,11-176, 11-191,11-192	E-4623	11-9,11-26, 11-27,11-28, 11-29,11-32, 11-33,11-34, 11-36,11-37, 11-39,11-40, 11-43,11-46, 11-50,11-54, 11-55	E-4629	11-9,11-23, 11-61,11-66, 11-67,11-69, 11-71,11-74, 11-76,11-78, 11-82,11-84, 11-100,11-105, 11-106,11-107, 11-108,11-110, 11-111,11-113, 11-115,11-116, 11-117,11-118, 11-119,11-120, 11-121,11-123, 11-124,11-125, 11-126,11-137, 11-138,11-139, 11-142,11-145, 11-146,11-147, 11-149,11-152, 11-154,11-155, 11-156,11-159, 11-161,11-162, 11-164,11-168, 11-170,11-171, 11-172,11-174, 11-176,11-177, 11-179,11-180, 11-182,11-183, 11-185,11-189, 11-191,11-192
E-4617	11-9,11-21, 11-32,11-47, 11-50,11-51, 11-58,11-61, 11-62,11-78, 11-80,11-82, 11-83,11-84, 11-88,11-101, 11-102,11-105, 11-106,11-107, 11-108,11-110, 11-111,11-112, 11-113,11-115, 11-116,11-117, 11-118,11-119, 11-120,11-121, 11-122,11-123, 11-124,11-125, 11-126,11-127, 11-132,11-134, 11-135,11-136, 11-137,11-142, 11-152,11-155, 11-156,11-157, 11-159,11-161, 11-162,11-170, 11-171,11-174, 11-176,11-177, 11-179,11-180, 11-182,11-183, 11-185,11-187, 11-189,11-190, 11-191,11-192	E-4619	11-9,11-32, 11-35,11-42, 11-44,11-56, 11-57,11-58, 11-61,11-106, 11-107,11-108, 11-112,11-134, 11-152,11-153, 11-174,11-176, 11-189,11-191, 11-192	E-4624	11-9,11-64, 11-70,11-71, 11-72,11-73, 11-74,11-77, 11-80,11-81, 11-82,11-85, 11-86,11-87, 11-89,11-93, 11-94,11-95, 11-96,11-97, 11-98,11-99, 11-103	E-4630	11-9,11-20, 11-21,11-141, 11-142,11-143, 11-145,11-146, 11-147,11-149, 11-154,11-155, 11-157,11-159, 11-160,11-161, 11-162,11-164, 11-165,11-167, 11-168,11-170, 11-171
		E-4620	11-9,11-64, 11-70,11-71, 11-72,11-76, 11-77,11-85, 11-86,11-87, 11-90,11-91, 11-93,11-94, 11-95	E-4625	11-9,11-64, 11-70,11-71, 11-72,11-73, 11-74,11-77, 11-80,11-81, 11-82,11-85, 11-86,11-87, 11-89,11-93, 11-94,11-95, 11-96,11-97, 11-98,11-99, 11-103	E-4631	11-9,11-20, 11-21,11-141, 11-142,11-143, 11-145,11-146, 11-147,11-149, 11-154,11-155, 11-157,11-159, 11-160,11-161, 11-162,11-164, 11-165,11-167, 11-168,11-170, 11-171
		E-4621	11-9,11-64, 11-70,11-71, 11-72,11-76, 11-77,11-85, 11-86,11-87, 11-90,11-91, 11-93,11-94, 11-95	E-4626	11-9,11-23, 11-61,11-66, 11-67,11-69, 11-71,11-74, 11-76,11-78, 11-82,11-84, 11-100,11-105, 11-106,11-107, 11-108,11-110, 11-111,11-113, 11-115,11-116, 11-117,11-118, 11-119,11-120, 11-121,11-122, 11-123,11-124, 11-125,11-126, 11-137,11-138, 11-139,11-142, 11-145,11-146, 11-147,11-149, 11-152,11-154, 11-155,11-156, 11-159,11-161, 11-162,11-164, 11-168,11-170, 11-171,11-174, 11-176,11-177, 11-179,11-180, 11-182,11-183,	E-4632	11-9,11-20, 11-21,11-141, 11-142,11-143, 11-145,11-146, 11-147,11-149, 11-154,11-155, 11-157,11-159, 11-160,11-161, 11-162,11-164, 11-165,11-167, 11-168,11-170, 11-171
		E-4622	11-9,11-26, 11-27,11-29, 11-32,11-33, 11-34,11-36, 11-37,11-39, 11-40,11-43,	E-4627	11-9,11-26, 11-27,11-28, 11-29,11-32, 11-33,11-34, 11-36,11-37, 11-39,11-40, 11-43,11-46, 11-50,11-54, 11-55	E-4633	11-8,11-25, 11-26,11-28, 11-32,11-36, 11-56,11-57, 11-151,11-153
						E-4634	11-8,11-25, 11-26,11-28, 11-32,11-36, 11-56,11-57, 11-151,11-153
						E-4635	11-8,11-25, 11-26,11-28,

MASTER PART NUMBER INDEX

Part No	Page	Part No	Page	Part No	Page	Part No	Page
E-4635 (cont)	11-32,11-36, 11-56,11-57, 11-151,11-153	E-4693B (cont)	11-150,11-153, 11-158,11-162, 11-163,11-166, 11-167	E-4713	Catalog 100	E-4806	Catalog 700
E-4636	11-8,11-64, 11-72,11-73, 11-74,11-76, 11-77,11-78, 11-79,11-80, 11-81,11-82, 11-84,11-85, 11-86,11-87, 11-89,11-93, 11-94,11-95, 11-96,11-97, 11-98,11-99, 11-101,11-102, 11-103,11-141, 11-151	E-4694C	11-3,11-5, 11-60,11-67, 11-68,11-94, 11-100,11-105, 11-106,11-108, 11-109,11-110, 11-111,11-112, 11-123,11-135, 11-144,11-146, 11-148,11-150, 11-153,11-163, 11-165,11-166, 11-167,11-171, 11-174,11-175, 11-180,11-181, 11-182,11-183, 11-189,11-190, 11-191	E-4714A	Catalog 100	E-4807	Catalog 700
E-4637	11-8,11-64, 11-72,11-73, 11-74,11-76, 11-77,11-78, 11-79,11-80, 11-81,11-82, 11-84,11-85, 11-86,11-87, 11-88,11-89, 11-93,11-94, 11-95,11-96, 11-97,11-98, 11-99,11-101, 11-102,11-103, 11-151	E-4695C	11-3,11-5, 11-60,11-109, 11-110,11-111, 11-112,11-132, 11-136,11-146, 11-175,11-179, 11-180,11-181, 11-182,11-183, 11-185	E-4715A	Catalog 100	E-4808	Catalog 700
E-4640	11-8,11-115, 11-116,11-119, 11-120,11-121, 11-122,11-124, 11-125,11-126, 11-127	E-4696B	11-2,11-5, 11-23,11-60, 11-109,11-110, 11-111,11-112, 11-144,11-145, 11-146,11-148, 11-163,11-175, 11-180,11-181, 11-182,11-185	E-4716	Catalog 100	E-4809	Catalog 700
E-4642	11-9,11-106, 11-134,11-153, 11-155,11-162, 11-163,11-189	E-4696C	11-2,11-5, 11-23,11-60, 11-109,11-110, 11-111,11-112, 11-144,11-146, 11-148,11-163, 11-175,11-180, 11-181,11-182, 11-185	E-4717	Catalog 100	E-4810	Catalog 700
E-4664	Catalog 700	E-4697B	11-2,11-5, 11-20,11-150, 11-156,11-163, 11-166	E-4718	Catalog 100	E-4811	Catalog 700
E-4669	Catalog 700	E-4702B	Catalog 100	E-4719	Catalog 100	E-4813	Catalog 700
E-4674	Catalog 700	E-4703B	Catalog 100	E-4720	Catalog 100	E-4814	Catalog 700
E-4675	Catalog 700	E-4704B	Catalog 100	E-4721	Catalog 100	E-4815	Catalog 700
E-4676	Catalog 700	E-4705B	Catalog 100	E-4722	Catalog 100	E-4816	Catalog 700
E-4677A	Catalog 700	E-4706B	Catalog 100	E-4723	Catalog 100	E-4817	Catalog 700
E-4678A	Catalog 700	E-4707B	Catalog 100	E-4732A	Catalog 100	E-4818	Catalog 700
E-4679	Catalog 700	E-4708B	Catalog 100	E-4733A	Catalog 100	E-4819	Catalog 700
E-4680	Catalog 700	E-4709B	Catalog 100	E-4736	Catalog 100	E-4822	Catalog 700
E-4681	Catalog 700	E-4710B	Catalog 100	E-4737A	Catalog 100	E-4823	Catalog 700
E-4682	Catalog 700	E-4711B	Catalog 100	E-4738A	Catalog 100	E-4824	Catalog 700
E-4683	Catalog 700	E-4712	Catalog 100	E-4739	Catalog 100	E-4825	Catalog 700
E-4684	Catalog 700			E-4740	Catalog 100	E-4827	Catalog 700
E-4685	Catalog 700			E-4741	Catalog 100	E-4828	Catalog 700
E-4686	Catalog 700			E-4742	Catalog 100	E-4830	Catalog 700
E-4687	Catalog 700			E-4744	Catalog 700	E-4832	Catalog 700
E-4688A	Catalog 700			E-4745	Catalog 700	E-4833	Catalog 700
E-4691	Catalog 100			E-4751	Catalog 700	E-4834A	Catalog 700
E-4692	Catalog 100			E-4752	Catalog 700	E-4835	Catalog 700
E-4693B	11-2,11-5, 11-20,11-144,			E-4753	Catalog 700	E-4837	Catalog 700
				E-4754	Catalog 700	E-4838	Catalog 700
				E-4755	Catalog 700	E-4839	Catalog 700
				E-4759	Catalog 700	E-4840	Catalog 700
				E-4761	Catalog 700	E-4844	Catalog 700
				E-4763	Catalog 700	E-4849	Catalog 100
				E-4764	Catalog 700	E-4850	Catalog 100
				E-4765	Catalog 700	E-4851	Catalog 100
				E-4767	Catalog 700	E-4852	Catalog 100
				E-4768	Catalog 700	E-4853	Catalog 100
				E-4770	Catalog 700	E-4854	Catalog 100
				E-4771	Catalog 700	E-4855	Catalog 100
				E-4773	Catalog 700	E-4856	Catalog 100
				E-4774	Catalog 700	E-4857	Catalog 100
				E-4775	Catalog 700	E-4858	Catalog 100
				E-4776	Catalog 700	E-4859	Catalog 100
				E-4777	Catalog 700	E-4861	Catalog 100
				E-4778	Catalog 700	E-4862	Catalog 100
				E-4779	Catalog 700	E-4863	Catalog 100
				E-4780	Catalog 700	E-4864	Catalog 100
				E-4781	Catalog 700	E-4865	Catalog 100
				E-4782	Catalog 700	E-4867	Catalog 100
				E-4785	Catalog 100	E-4868	Catalog 100
				E-4786	Catalog 700	E-4869	Catalog 100
				E-4788A	Catalog 700	E-4870	Catalog 100
				E-4789	Catalog 700	E-4871	Catalog 100
				E-4790	Catalog 700	E-4873	Catalog 100
				E-4791	Catalog 700	E-4874	Catalog 100
				E-4792	Catalog 700	E-4875	Catalog 100
				E-4793	Catalog 700	E-4876	Catalog 100
				E-4794	Catalog 700	E-4877	Catalog 100
				E-4795	Catalog 700	E-4878	Catalog 100
				E-4796	Catalog 700	E-4879	Catalog 100
				E-4798	Catalog 700	E-4880S	Catalog 100
				E-4800	Catalog 100	E-4880SHD	Catalog 100
				E-4801	Catalog 700	E-4881	Catalog 100
				E-4802	Catalog 700	E-4884	Catalog 100
				E-4803	Catalog 700	E-4885	Catalog 100
				E-4804	Catalog 700	E-4886	Catalog 100
				E-4805	Catalog 700	E-4887	Catalog 100

MASTER PART NUMBER INDEX

Part No	Page	Part No	Page	Part No	Page	Part No	Page
E-4888	Catalog 100	E-4990A	Catalog 100	E-5123	Catalog 100	E-5189	Catalog 200
E-4889	Catalog 100	E-4991	Catalog 100	E-5124	Catalog 100	E-5190	Catalog 200
E-4890	Catalog 100	E-4992	Catalog 100	E-5125	Catalog 100	E-5191	Catalog 200
E-4891	Catalog 100	E-4993	Catalog 100	E-5126	Catalog 100	E-5192	Catalog 200
E-4892	Catalog 100	E-4994	Catalog 100	E-5127	Catalog 100	E-5193	Catalog 200
E-4893	Catalog 100	E-4995	Catalog 100	E-5128	Catalog 100	E-5195	Catalog 200
E-4900	Catalog 100	E-4996	Catalog 100	E-5129	Catalog 100	E-5197	Catalog 200
E-4901	Catalog 100	E-4997	Catalog 100	E-512S	Catalog 100	E-5198	Catalog 200
E-4902	Catalog 100	E-4998	Catalog 100	E-5130	Catalog 100	E-5199	Catalog 200
E-4904	Catalog 100	E-5007	Catalog 100	E-5131	Catalog 100	E-5200	Catalog 200
E-4910A	Catalog 100	E-5008	Catalog 100	E-5132	Catalog 100	E-5201	Catalog 200
E-4911A	Catalog 100	E-5012	Catalog 100	E-5133	Catalog 100	E-5202	Catalog 200
E-4912	Catalog 100	E-5018	Catalog 100	E-5134	Catalog 100	E-5203	Catalog 200
E-4913	Catalog 100	E-5032	Catalog 100	E-5135	Catalog 100	E-5204	Catalog 200
E-4916	Catalog 100	E-5036	Catalog 100	E-5136	Catalog 100	E-5205	Catalog 100
E-4917	Catalog 100	E-5040A	Catalog 100	E-5137	Catalog 100	E-5206	Catalog 100
E-4918	Catalog 100	E-5044	Catalog 100	E-5138	Catalog 100	E-5207	Catalog 100
E-4919	Catalog 100	E-5045	Catalog 100	E-5139	Catalog 100	E-5208	Catalog 100
E-4934A	Catalog 100	E-5046	Catalog 100	E-5140	Catalog 100	E-5209	Catalog 100
E-4935	Catalog 100	E-5047	Catalog 100	E-5140-2	Catalog 100	E-5210	Catalog 700
E-4936	Catalog 100	E-5055	Catalog 100	E-5141	Catalog 100	E-5211	Catalog 700
E-4937	Catalog 100	E-5056	Catalog 100	E-5144	Catalog 100	E-5212	Catalog 700
E-4940	Catalog 100	E-5057	Catalog 100	E-5145	Catalog 200	E-5213	Catalog 700
E-4941	Catalog 100	E-5058	Catalog 100	E-5146	Catalog 200	E-5214	Catalog 700
E-4942	Catalog 100	E-5059	Catalog 100	E-5147	Catalog 200	E-5215	Catalog 700
E-4944	Catalog 100	E-5060	Catalog 100	E-5148	Catalog 200	E-5216	Catalog 700
E-4945	Catalog 100	E-5061	Catalog 100	E-5149	Catalog 200	E-5218	Catalog 700
E-4946	Catalog 100	E-5062	Catalog 100	E-5150	Catalog 200	E-5219	Catalog 700
E-4947	Catalog 100	E-5063	Catalog 100	E-5151	Catalog 200	E-5220	Catalog 700
E-4948	Catalog 100	E-5066	Catalog 100	E-5152	Catalog 200	E-5221	Catalog 700
E-4949	Catalog 100	E-5067	Catalog 100	E-5153	Catalog 200	E-5222	Catalog 700
E-4950	Catalog 100	E-5070	Catalog 700	E-5154	Catalog 200	E-5223	Catalog 700
E-4951	Catalog 100	E-5071	Catalog 700	E-5155	Catalog 200	E-5224	Catalog 700
E-4952	Catalog 100	E-5072	Catalog 700	E-5156	Catalog 200	E-5225	Catalog 700
E-4953	Catalog 100	E-5073	Catalog 700	E-5157	Catalog 200	E-5226	Catalog 700
E-4955	Catalog 100	E-5074	Catalog 700	E-5158	Catalog 200	E-5227	Catalog 700
E-4956A	Catalog 100	E-5075	Catalog 700	E-5159	Catalog 200	E-5228	Catalog 700
E-4956A-PL	Catalog 100	E-5076	Catalog 700	E-5160	Catalog 200	E-5230	Catalog 700
E-4957	Catalog 100	E-5077	Catalog 700	E-5161	Catalog 200	E-5231	Catalog 700
E-4958	Catalog 100	E-5079	Catalog 700	E-5162	Catalog 200	E-5239	Catalog 100
E-4960	Catalog 100	E-5080	Catalog 700	E-5163	Catalog 200	E-5240A	Catalog 100
E-4961A	Catalog 100	E-5081	Catalog 700	E-5164	Catalog 200	E-5241A	Catalog 100
E-4962	Catalog 100	E-5082	Catalog 700	E-5165	Catalog 200	E-5242A	Catalog 100
E-4963	Catalog 100	E-5083	Catalog 700	E-5166	Catalog 200	E-5243A	Catalog 100
E-4963-PL	Catalog 100	E-5085	Catalog 700	E-5167	Catalog 200	E-5244A	Catalog 100
E-4964-L	Catalog 100	E-5086	Catalog 100	E-5168	Catalog 200	E-5245	Catalog 700
E-4964-R	Catalog 100	E-5087	Catalog 100	E-5169	Catalog 200	E-5246	Catalog 700
E-4965-L	Catalog 100	E-5088	Catalog 100	E-5170	Catalog 200	E-5247	Catalog 700
E-4965-R	Catalog 100	E-5089	Catalog 100	E-5171	Catalog 200	E-5253	Catalog 700
E-4966-L	Catalog 100	E-5092	Catalog 100	E-5172	Catalog 200	E-5254	Catalog 700
E-4966-R	Catalog 100	E-5093	Catalog 100	E-5173	Catalog 200	E-5255A	Catalog 700
E-4967-L	Catalog 100	E-5094A	Catalog 100	E-5174	Catalog 200	E-5256	Catalog 700
E-4967-R	Catalog 100	E-5095	Catalog 100	E-5175	Catalog 200	E-5257	Catalog 700
E-4968-L	Catalog 100	E-5096	Catalog 100	E-5176	Catalog 200	E-5258	Catalog 700
E-4968-R	Catalog 100	E-5097	Catalog 100	E-5177	Catalog 200	E-5259	Catalog 700
E-4969-L	Catalog 100	E-5107	Catalog 100	E-5178	Catalog 200	E-5260	Catalog 700
E-4969-R	Catalog 100	E-5108	Catalog 100	E-5179	Catalog 200	E-5261	Catalog 700
E-4975-R	Catalog 100	E-5111	Catalog 100	E-5180	Catalog 200	E-5262	Catalog 700
E-4976-R	Catalog 100	E-5113	Catalog 100	E-5182	Catalog 200	E-5263	Catalog 700
E-4979-R	Catalog 100	E-5115	Catalog 100	E-5183	Catalog 200	E-5264	Catalog 700
E-4987A	Catalog 100	E-5116	Catalog 100	E-5185	Catalog 200	E-5265	Catalog 700
E-4988-L	Catalog 100	E-5118	Catalog 100	E-5186	Catalog 200	E-5267	Catalog 700
E-4988-R	Catalog 100	E-5119	Catalog 100	E-5187	Catalog 200	E-5268	Catalog 700
E-4989	Catalog 100	E-5122	Catalog 100	E-5188	Catalog 200	E-5269	Catalog 700

MASTER PART NUMBER INDEX

Part No	Page	Part No	Page	Part No	Page	Part No	Page
E-5270	Catalog 700	E-5374 (cont)	11-83,11-84,	E-5470 (cont)	11-164,11-167,	E-5553-L	Catalog 100
E-5271	Catalog 700		11-85,11-89,		11-168	E-5553-R	Catalog 100
E-5272	Catalog 700		11-100	E-5476	Catalog 100	E-5554-L	Catalog 100
E-5273	Catalog 700	E-5378	11-14,11-113	E-5477	Catalog 100	E-5554-R	Catalog 100
E-5274	Catalog 700	E-5379	11-15,11-113	E-5478	Catalog 100	E-5556-L	Catalog 100
E-5275	Catalog 700	E-5380	11-15,11-113	E-5480	Catalog 100	E-5556-R	Catalog 100
E-5276	Catalog 700	E-5386	11-11,11-147,	E-5481A	Catalog 100	E-5557-L	Catalog 100
E-5277	Catalog 700		11-154	E-5482	Catalog 100	E-5557-R	Catalog 100
E-5278	Catalog 700	E-5390	11-11,11-165,	E-5487	Catalog 100	E-5558-L	Catalog 100
E-5281	Catalog 700		11-169	E-5488	Catalog 200	E-5558-R	Catalog 100
E-5282	Catalog 700	E-5391	11-9,11-62,	E-5489	Catalog 200	E-5559-L	Catalog 100
E-5283	Catalog 700		11-189,11-190,	E-5490	Catalog 100	E-5559-R	Catalog 100
E-5286	Catalog 700		11-191	E-5491	Catalog 100	E-5560-L	Catalog 100
E-5292	Catalog 700	E-5392	11-8,11-73,	E-5492	Catalog 100	E-5560-R	Catalog 100
E-5293	Catalog 700		11-74,11-88	E-5493	Catalog 100	E-5561-L	Catalog 100
E-5299	Catalog 700	E-5402	11-9,11-183,	E-5494	Catalog 100	E-5561-R	Catalog 100
E-5300	Catalog 700		11-189,11-190	E-5495	Catalog 100	E-5570	Catalog 100
E-5301	Catalog 700	E-5407	Catalog 200	E-5496	Catalog 100	E-5571A	Catalog 100
E-5303A	Catalog 100	E-5407X	Catalog 200	E-5497	Catalog 100	E-5572A	Catalog 100
E-5304	Catalog 100	E-5408	Catalog 200	E-5498	Catalog 100	E-5573	Catalog 100
E-5305	Catalog 100	E-5408X	Catalog 200	E-5499	Catalog 100	E-5576-L	Catalog 100
E-5306	Catalog 100	E-5409	Catalog 200	E-5500	Catalog 100	E-5576-R	Catalog 100
E-5307	Catalog 100	E-5410	Catalog 200	E-5501	Catalog 100	E-5578-R	Catalog 100
E-5307-2	Catalog 100	E-5411	Catalog 200	E-5501-2	Catalog 100	E-5579-L	Catalog 100
E-5308	Catalog 700	E-5412	Catalog 200	E-5503	Catalog 100	E-5579-R	Catalog 100
E-5309	Catalog 700	E-5413	Catalog 200	E-5504A	Catalog 100	E-5585-L	Catalog 100
E-5310	11-11,11-25,	E-5413X	Catalog 200	E-5505A	Catalog 100	E-5585-R	Catalog 100
	11-27,11-30,	E-5414	Catalog 200	E-5506	Catalog 100	E-5587-L	Catalog 100
	11-38,11-39,	E-5414X	Catalog 200	E-5507	Catalog 100	E-5587-R	Catalog 100
	11-41,11-53	E-5417	Catalog 700	E-5508	Catalog 100	E-5588-L	Catalog 100
E-5325	11-13,11-48,	E-5419	Catalog 700	E-5509	Catalog 100	E-5588-R	Catalog 100
	11-49,11-52,	E-5420	Catalog 700	E-5510	Catalog 100	E-5589-L	Catalog 100
	11-53	E-5421	Catalog 700	E-5511	Catalog 100	E-5589-R	Catalog 100
E-5326	11-12,11-68,	E-5422	Catalog 700	E-5512	Catalog 100	E-5610-R	Catalog 100
	11-69,11-80,	E-5423	Catalog 700	E-5513	Catalog 100	E-5612-R	Catalog 100
	11-81,11-82,	E-5424	Catalog 700	E-5515	Catalog 100	E-5613-R	Catalog 100
	11-83,11-84,	E-5425	Catalog 700	E-5516	Catalog 100	E-5618-L	Catalog 100
	11-85,11-89,	E-5426	Catalog 700	E-5517	Catalog 100	E-5618-R	Catalog 100
	11-95	E-5427	Catalog 700	E-5518	Catalog 100	E-5632	Catalog 100
E-5338	11-13,11-27,	E-5428	Catalog 700	E-5519	Catalog 100	E-5652-L	Catalog 100
	11-30,11-33,	E-5429	Catalog 700	E-5520	Catalog 100	E-5652-R	Catalog 100
	11-38,11-41,	E-5432	Catalog 700	E-5521	Catalog 100	E-5682	Catalog 100
	11-44	E-5433	Catalog 700	E-5522	Catalog 100	E-5683	Catalog 100
E-5339	11-13,11-27,	E-5434	Catalog 700	E-5523	Catalog 100	E-5702	Catalog 100
	11-30,11-33,	E-5435	Catalog 700	E-5524	Catalog 100	E-5704	Catalog 100
	11-38,11-41,	E-5436	Catalog 700	E-5525	Catalog 100	E-5706	Catalog 100
	11-44	E-5439	Catalog 700	E-5526	Catalog 100	E-5708	Catalog 100
E-5342	11-15,11-48,	E-5441B	11-4,11-5	E-5527	Catalog 100	E-5710	Catalog 100
	11-49,11-52,	E-5442	11-6	E-5528	Catalog 100	E-5711	Catalog 100
	11-53	E-5444	11-6	E-5529	Catalog 100	E-5712	Catalog 100
E-5366	11-13,11-165,	E-5445	11-6	E-5530	Catalog 100	E-5713-L	Catalog 100
	11-166,11-169	E-5446	11-6	E-5531	Catalog 100	E-5713-R	Catalog 100
E-5372	11-12,11-67,	E-5449	11-6	E-5532	Catalog 100	E-5714-L	Catalog 100
	11-72,11-73,	E-5450	11-6	E-5537	Catalog 100	E-5714-R	Catalog 100
	11-74,11-75	E-5453	Catalog 700	E-5538	Catalog 100	E-5715-L	Catalog 100
E-5373	11-12,11-65,	E-5457	Catalog 700	E-5539	Catalog 100	E-5715-R	Catalog 100
	11-67,11-72,	E-5458	Catalog 700	E-5540	Catalog 100	E-5716-L	Catalog 100
	11-73,11-74,	E-545A	Catalog 100	E-5541	Catalog 100	E-5716-R	Catalog 100
	11-75,11-88,	E-5469	11-8,11-20,	E-5542	Catalog 100	E-5717-L	Catalog 100
	11-92		11-149,11-154,	E-5543	Catalog 100	E-5717-R	Catalog 100
E-5374	11-12,11-68,		11-164,11-167,	E-5544	Catalog 100	E-5718-L	Catalog 100
	11-69,11-78,		11-168	E-5545	Catalog 100	E-5718-R	Catalog 100
	11-79,11-80,	E-5470	11-8,11-20,	E-5551-L	Catalog 100	E-5719-L	Catalog 100
	11-81,11-82,		11-149,11-154,	E-5551-R	Catalog 100	E-5719-R	Catalog 100

MASTER PART NUMBER INDEX

Part No	Page	Part No	Page	Part No	Page	Part No	Page
E-5720-L	Catalog 100	E-5825	Catalog 100	E-5922-L	Catalog 100	E-5987-L	Catalog 100
E-5720-R	Catalog 100	E-5827	Catalog 100	E-5922-R	Catalog 100	E-5987-R	Catalog 100
E-5721-L	Catalog 100	E-5828	Catalog 100	E-5923-L	Catalog 100	E-5988-L	Catalog 100
E-5721-R	Catalog 100	E-5829	Catalog 100	E-5923-R	Catalog 100	E-5988-L-PL	Catalog 100
E-5722-L	Catalog 100	E-5833	Catalog 100	E-5924-L	Catalog 100	E-5988-R	Catalog 100
E-5722-R	Catalog 100	E-5834	Catalog 100	E-5924-R	Catalog 100	E-5988-R-PL	Catalog 100
E-5724	Catalog 100	E-5837	Catalog 100	E-5925	Catalog 100	E-5989-L	Catalog 100
E-5726	Catalog 100	E-5838	Catalog 100	E-5926	Catalog 100	E-5989-R	Catalog 100
E-5727	Catalog 100	E-5839	Catalog 100	E-5927	Catalog 100	E-5990-L	Catalog 100
E-5728	Catalog 100	E-583X	Catalog 100	E-5929-L	Catalog 100	E-5990-R	Catalog 100
E-5729	Catalog 100	E-5840	Catalog 100	E-5929-R	Catalog 100	E-5991	Catalog 100
E-5734	Catalog 100	E-5841	Catalog 100	E-5930-L	Catalog 100	E-5991-PL	Catalog 100
E-5736	Catalog 100	E-5850	Catalog 100	E-5930-R	Catalog 100	E-5992A	Catalog 100
E-5737	Catalog 100	E-5851	Catalog 100	E-5931-L	Catalog 100	E-5993	Catalog 100
E-5738	Catalog 100	E-5854	Catalog 100	E-5931-R	Catalog 100	E-5994	Catalog 100
E-5739	Catalog 100	E-5855	Catalog 100	E-5932-L	Catalog 100	E-5995-L	Catalog 100
E-5740	Catalog 100	E-5856	Catalog 100	E-5932-R	Catalog 100	E-5995-R	Catalog 100
E-5742	Catalog 100	E-5857	Catalog 100	E-5933-L	Catalog 100	E-5996-L	Catalog 100
E-5743	Catalog 100	E-5859	Catalog 100	E-5933-R	Catalog 100	E-5996-R	Catalog 100
E-5746	Catalog 100	E-5868-L	Catalog 100	E-5935-L	Catalog 100	E-5997	Catalog 100
E-5747	Catalog 100	E-5868-R	Catalog 100	E-5935-R	Catalog 100	E-5998	Catalog 100
E-5748-L	Catalog 100	E-5869-L	Catalog 100	E-5936-L	Catalog 100	E-5999	Catalog 100
E-5748-R	Catalog 100	E-5869-R	Catalog 100	E-5936-R	Catalog 100	E-6000A	Catalog 100
E-5749-L	Catalog 100	E-5870-L	Catalog 100	E-5937-L	Catalog 100	E-6000A-PL	Catalog 100
E-5749-R	Catalog 100	E-5870-R	Catalog 100	E-5937-R	Catalog 100	E-6001A	Catalog 100
E-5750-L	Catalog 100	E-5871-L	Catalog 100	E-5944	Catalog 100	E-6023-L	Catalog 100
E-5750-R	Catalog 100	E-5871-R	Catalog 100	E-5946	Catalog 100	E-6023-R	Catalog 100
E-5753	Catalog 100	E-5872	Catalog 100	E-5947	Catalog 100	E-6024-L	Catalog 100
E-5754	Catalog 100	E-5876-L	Catalog 100	E-5949	Catalog 100	E-6024-R	Catalog 100
E-5755	Catalog 100	E-5876-R	Catalog 100	E-5952	Catalog 100	E-6026-L	Catalog 100
E-5756-L	Catalog 100	E-5882	Catalog 100	E-5953	Catalog 100	E-6026-R	Catalog 100
E-5756-R	Catalog 100	E-5883	Catalog 100	E-5954	Catalog 100	E-6027-L	Catalog 100
E-5757-L	Catalog 100	E-5885	Catalog 100	E-5955	Catalog 100	E-6027-R	Catalog 100
E-5757-R	Catalog 100	E-5887	Catalog 100	E-5957	Catalog 100	E-6028-L	Catalog 100
E-5761	Catalog 100	E-5889	Catalog 100	E-5960	Catalog 100	E-6028-R	Catalog 100
E-5763-L	Catalog 100	E-5890	Catalog 100	E-5961	Catalog 100	E-6029A	Catalog 100
E-5763-R	Catalog 100	E-5891	Catalog 100	E-5962	Catalog 100	E-6030A	Catalog 100
E-5764-L	Catalog 100	E-5892	Catalog 100	E-5963	Catalog 100	E-6033-L	Catalog 100
E-5764-R	Catalog 100	E-5896-L	Catalog 100	E-5964	Catalog 100	E-6033-R	Catalog 100
E-5765-L	Catalog 100	E-5896-R	Catalog 100	E-596A	Catalog 100	E-6034	Catalog 100
E-5765-R	Catalog 100	E-5897-L	Catalog 100	E-5970	Catalog 100	E-6035	Catalog 100
E-5766-L	Catalog 100	E-5897-R	Catalog 100	E-5970-PL	Catalog 100	E-6036	Catalog 100
E-5766-R	Catalog 100	E-5898-L	Catalog 100	E-5971	Catalog 100	E-6038	Catalog 100
E-5775	Catalog 100	E-5898-R	Catalog 100	E-5972	Catalog 100	E-6039	Catalog 100
E-5776	Catalog 100	E-5899-L	Catalog 100	E-5972-PL	Catalog 100	E-6040	Catalog 100
E-5778	Catalog 100	E-5899-R	Catalog 100	E-5973	Catalog 100	E-6041	Catalog 100
E-5780	Catalog 100	E-5900-L	Catalog 100	E-5974	Catalog 100	E-6053	Catalog 100
E-5781	Catalog 100	E-5900-R	Catalog 100	E-5976	Catalog 100	E-6054	Catalog 100
E-5782	Catalog 100	E-5902	Catalog 100	E-5977-L	Catalog 100	E-6057-L	Catalog 100
E-5783	Catalog 100	E-5904A	Catalog 100	E-5977-LC	Catalog 100	E-6057-R	Catalog 100
E-5784A	Catalog 100	E-5905A	Catalog 100	E-5977-L-PL	Catalog 100	E-6058-L	Catalog 100
E-5785A	Catalog 100	E-5906	Catalog 100	E-5977-R	Catalog 100	E-6058-R	Catalog 100
E-5796	Catalog 100	E-5909-L	Catalog 100	E-5977-RC	Catalog 100	E-6059-L	Catalog 100
E-5798	Catalog 100	E-5909-R	Catalog 100	E-5977-R-PL	Catalog 100	E-6059-R	Catalog 100
E-5799	Catalog 100	E-5910-L	Catalog 100	E-5978-L	Catalog 100	E-6060-L	Catalog 100
E-579A	Catalog 100	E-5910-R	Catalog 100	E-5978-R	Catalog 100	E-6060-R	Catalog 100
E-5800	Catalog 100	E-5911-L	Catalog 100	E-5982-L	Catalog 100	E-6061	Catalog 100
E-5801	Catalog 100	E-5911-R	Catalog 100	E-5982-R	Catalog 100	E-6064	Catalog 100
E-5816	Catalog 100	E-5916-L	Catalog 100	E-5983-L	Catalog 100	E-6065	Catalog 100
E-5820	Catalog 100	E-5916-R	Catalog 100	E-5983-R	Catalog 100	E-6066	Catalog 100
E-5821	Catalog 100	E-5918-L	Catalog 100	E-5985-L	Catalog 100	E-6067	Catalog 100
E-5822	Catalog 100	E-5918-R	Catalog 100	E-5985-R	Catalog 100	E-6068	Catalog 100
E-5823	Catalog 100	E-5920-L	Catalog 100	E-5986-L	Catalog 100	E-6069	Catalog 100
E-5824	Catalog 100	E-5920-R	Catalog 100	E-5986-R	Catalog 100	E-6070	Catalog 100

MASTER PART NUMBER INDEX

Part No	Page	Part No	Page	Part No	Page	Part No	Page
E-6071	Catalog 100	E-6195B (cont)	11-49	E-6816 (cont)	11-71,11-72, 11-73,11-74, 11-75,11-87, 11-88,11-92, 11-94	E-6856 (cont)	11-177,11-179, 11-180,11-182, 11-183,11-185, 11-189,11-191
E-6072	Catalog 100	E-6196B	11-3,11-5, 11-31,11-33, 11-34,11-35, 11-36,11-39, 11-42,11-45, 11-49	E-6817	11-11,11-68, 11-69,11-100	E-6857	11-10,11-21, 11-61,11-105, 11-107,11-110, 11-111,11-137, 11-139,11-142, 11-143,11-176, 11-177,11-179, 11-180,11-182, 11-183,11-185, 11-189,11-191
E-6073	Catalog 100			E-6818	11-11,11-174, 11-177		
E-6074	Catalog 100	E-6197B	11-2,11-5, 11-33,11-34, 11-45,11-49, 11-55	E-6819	11-15,11-174, 11-177		
E-6075	Catalog 100			E-6825	11-14,11-109, 11-110,11-111		
E-6076	Catalog 100	E-6198B	11-1,11-5, 11-20,11-141, 11-142,11-143, 11-160,11-161, 11-166	E-6827	11-14,11-27, 11-30,11-38, 11-41,11-44	E-6858	11-9,11-106, 11-134,11-152, 11-153,11-155, 11-162,11-163, 11-189
E-6077	Catalog 100			E-6833	11-13,11-65, 11-67,11-72, 11-75,11-92		
E-6078	Catalog 100	E-6199B	11-3,11-5, 11-105,11-109, 11-110,11-111, 11-133,11-135, 11-144,11-145, 11-146,11-148, 11-163,11-175, 11-179,11-180, 11-181,11-182, 11-185	E-6834	11-13,11-67, 11-72,11-75	E-6863	11-10,11-26, 11-28,11-29, 11-36,11-37, 11-40,11-43
E-6080	Catalog 100			E-6835	11-15,11-48, 11-49,11-52, 11-53	E-6864	11-10,11-26, 11-28,11-29, 11-36,11-37, 11-40,11-43
E-6101	Catalog 100	E-6199C	11-3,11-5, 11-42,11-60, 11-105,11-109, 11-110,11-111, 11-133,11-135, 11-144,11-145, 11-146,11-148, 11-163,11-165, 11-166,11-167, 11-175,11-179, 11-180,11-181, 11-182,11-185	E-6836	11-13,11-27, 11-30,11-38, 11-41,11-44		
E-6102	Catalog 100			E-6839	11-15,11-48, 11-52	E-6865B	11-1
E-6103	Catalog 100	E-6403	11-9	E-6847	11-9,11-61, 11-100,11-105, 11-107,11-108, 11-112,11-134, 11-135,11-147, 11-149,11-152, 11-154,11-155, 11-159,11-171, 11-174,11-176, 11-191	E-6868B	11-3,11-5, 11-60,11-109, 11-110,11-111, 11-112,11-132, 11-136,11-146, 11-175,11-179, 11-180,11-181, 11-182,11-183, 11-185
E-6104	Catalog 100	E-6404	11-9	E-6848	11-9,11-61, 11-100,11-105, 11-107,11-108, 11-112,11-134, 11-135,11-147, 11-149,11-152, 11-154,11-155, 11-159,11-171, 11-174,11-176, 11-191	E-6869C	11-2,11-5, 11-23
E-6109	Catalog 100	E-6450B	11-1,11-5			E-6875C	11-2,11-5, 11-20,11-144, 11-146,11-148, 11-155,11-158, 11-162,11-163, 11-164,11-166, 11-167
E-6110	Catalog 100	E-6451B	11-1,11-5	E-6849	11-8,11-165	E-6878	11-12,11-165
E-6111	Catalog 100	E-6453B	11-1,11-5	E-6854	11-10,11-65, 11-66,11-72, 11-75,11-91, 11-92	E-6879	Catalog 100
E-6112	Catalog 100	E-6454B	11-1			E-6880	Catalog 100
E-6113	Catalog 100	E-6454C	11-1,11-5			E-6881	Catalog 100
E-6114	Catalog 200	E-6455B	11-1,11-5			E-6884	Catalog 100
E-6115	Catalog 200	E-6455C	11-1,11-5			E-6885	Catalog 100
E-6116	Catalog 200	E-6665	11-8			E-6887	Catalog 200
E-6117	Catalog 200	E-6678	11-8			E-6888	Catalog 200
E-6118	Catalog 200	E-6694	11-9			E-6889	Catalog 200
E-6119	Catalog 200	E-6720	11-8			E-688A	Catalog 100
E-6120	Catalog 200	E-6722	11-8			E-6890	Catalog 200
E-6120X	Catalog 200	E-6774	11-8			E-6891	Catalog 200
E-6121	Catalog 700	E-6789	11-8			E-6892	Catalog 200
E-6122	Catalog 700	E-6804	11-11,11-165, 11-169	E-6855	11-10,11-65, 11-66,11-72, 11-75,11-91, 11-92	E-6893	Catalog 200
E-6124	Catalog 700	E-6806	11-13,11-183, 11-189,11-190			E-6894	Catalog 200
E-6126	Catalog 700	E-6808	11-11,11-170, 11-172	E-6856	11-10,11-21, 11-61,11-105, 11-107,11-110, 11-111,11-137, 11-139,11-142, 11-143,11-176,	E-6895	Catalog 200
E-6127	Catalog 700					E-6896	Catalog 200
E-6128	Catalog 700	E-6815	11-11,11-68, 11-69,11-100			E-6898	Catalog 700
E-6129	Catalog 700	E-6816	11-11,11-65, 11-67,11-70,				
E-612-BK	Catalog 100						
E-612HD	Catalog 100						
E-6130	Catalog 700						
E-6131	Catalog 700						
E-6135	11-10,11-147, 11-149,11-167, 11-168						
E-6136	11-10,11-147, 11-149,11-167, 11-168						
E-6137	Catalog 100						
E-6138	Catalog 100						
E-6139	Catalog 100						
E-6140	Catalog 100						
E-6141	Catalog 100						
E-6142	Catalog 100						
E-6144	Catalog 100						
E-6145	Catalog 100						
E-6146	Catalog 100						
E-6147	Catalog 100						
E-6148	Catalog 100						
E-6194B	11-3,11-5, 11-66,11-112, 11-175						
E-6194C	11-3,11-5, 11-23,11-112, 11-175						
E-6195B	11-1,11-5, 11-25,11-28, 11-36,11-39, 11-42,11-45,						

MASTER PART NUMBER INDEX

Part No	Page	Part No	Page	Part No	Page	Part No	Page
E-689A	Catalog 100	E-7034	Catalog 100	E-7408	Catalog 100	E-7492	Catalog 700
E-6900A	Catalog 100	E-7035	Catalog 100	E-7410	Catalog 100	E-7493	Catalog 700
E-6902A	Catalog 100	E-7043	Catalog 100	E-7411	Catalog 100	E-7497	Catalog 700
E-6903A	Catalog 100	E-7044	Catalog 100	E-7418	Catalog 200	E-7498	Catalog 700
E-6905A	Catalog 100	E-7098	Catalog 200	E-7418-21	Catalog 100	E-7499	Catalog 700
E-6906A	Catalog 100	E-7120	Catalog 200	E-7424	Catalog 200	E-7500	Catalog 700
E-6907A	Catalog 100	E-7122	Catalog 200	E-7425	Catalog 200	E-7501	Catalog 700
E-6912	Catalog 100	E-7124	Catalog 200	E-7426	Catalog 700	E-7502	Catalog 700
E-6913	Catalog 100	E-7125	Catalog 100	E-7427	Catalog 700	E-7503	Catalog 700
E-6914A	Catalog 100	E-7129	Catalog 200	E-7429	Catalog 700	E-7504	Catalog 700
E-6918A	Catalog 100	E-7130	Catalog 200	E-7430	Catalog 700	E-7505	Catalog 700
E-6919A	Catalog 100	E-7161	Catalog 100	E-7431	Catalog 700	E-7506	Catalog 700
E-6923B	Catalog 100	E-7162	Catalog 100	E-7432	Catalog 700	E-7507	Catalog 700
E-6924B	Catalog 100	E-7163	Catalog 100	E-7433	Catalog 700	E-7508	Catalog 700
E-6925B	Catalog 100	E-7164	Catalog 100	E-7434	Catalog 700	E-7509	Catalog 700
E-6927B	Catalog 100	E-7165	Catalog 100	E-7439	Catalog 700	E-7510	Catalog 700
E-6928	Catalog 100	E-7166	Catalog 100	E-7440	Catalog 700	E-7515	Catalog 700
E-6932	Catalog 100	E-7167	Catalog 100	E-7441	Catalog 700	E-7516	Catalog 700
E-6933	Catalog 100	E-7180	Catalog 200	E-7442	Catalog 700	E-7517	Catalog 700
E-6934	Catalog 100	E-7181	Catalog 200	E-7443	Catalog 700	E-7518	Catalog 700
E-6936	Catalog 100	E-7182	Catalog 200	E-7444	Catalog 700	E-7520	Catalog 700
E-6940	Catalog 100	E-7183	Catalog 200	E-7445	Catalog 700	E-7522	Catalog 700
E-6942	Catalog 100	E-7184	Catalog 200	E-7446A	Catalog 700	E-7523	Catalog 700
E-6944	Catalog 100	E-7185	Catalog 200	E-7447	Catalog 700	E-7524	Catalog 700
E-6946	Catalog 100	E-7186	Catalog 200	E-7448	Catalog 700	E-7525	Catalog 700
E-6947	Catalog 100	E-7188	Catalog 200	E-7449	Catalog 700	E-7526	Catalog 700
E-6951A	Catalog 100	E-7189	Catalog 200	E-7450	Catalog 700	E-7527	Catalog 700
E-6954	Catalog 100	E-7190	Catalog 200	E-7451	Catalog 700	E-7528	Catalog 700
E-6956	Catalog 100	E-7191	Catalog 200	E-7452	Catalog 700	E-7529	Catalog 700
E-6957	Catalog 100	E-7192	Catalog 200	E-7453	Catalog 700	E-7530	Catalog 700
E-6958	Catalog 100	E-7196	Catalog 200	E-7455	Catalog 700	E-7531	Catalog 700
E-6960	Catalog 100	E-7197	Catalog 200	E-7457	Catalog 700	E-7532	Catalog 700
E-6966A	Catalog 100	E-7198	Catalog 200	E-7458	Catalog 700	E-7533	Catalog 700
E-6967A	Catalog 100	E-7199	Catalog 200	E-7459	Catalog 700	E-7534	Catalog 700
E-6979	Catalog 700	E-7208	Catalog 200	E-7460	Catalog 700	E-7535	Catalog 700
E-6980	Catalog 700	E-7208X	Catalog 200	E-7461	Catalog 700	E-7536	Catalog 700
E-6981	Catalog 100	E-7210	Catalog 200	E-7462	Catalog 700	E-7537	Catalog 700
E-6982	Catalog 100	E-7211	Catalog 100	E-7463	Catalog 700	E-7540	Catalog 700
E-6983	Catalog 100	E-7212A	Catalog 100	E-7464	Catalog 700	E-7541	Catalog 700
E-6984	Catalog 100	E-7213A	Catalog 100	E-7465	Catalog 700	E-7543	Catalog 700
E-6985	Catalog 100	E-7214A	Catalog 100	E-7466	Catalog 700	E-7544	Catalog 700
E-6987	Catalog 100	E-7216	Catalog 100	E-7467	Catalog 700	E-7557	Catalog 700
E-6988	Catalog 100	E-7217	Catalog 100	E-7468	Catalog 700	E-7560	Catalog 700
E-6989	Catalog 100	E-7218	Catalog 100	E-7469	Catalog 700	E-7562	Catalog 700
E-6990	Catalog 100	E-7219	Catalog 100	E-7470	Catalog 700	E-7563	Catalog 700
E-6991	Catalog 100	E-7220	Catalog 100	E-7471	Catalog 700	E-7564	Catalog 700
E-6992	Catalog 100	E-7230	Catalog 100	E-7472	Catalog 700	E-7566	Catalog 700
E-6993	Catalog 100	E-7231	Catalog 100	E-7473	Catalog 700	E-7568A	Catalog 700
E-6994	Catalog 100	E-7232	Catalog 100	E-7474	Catalog 700	E-7569A	Catalog 700
E-6995	Catalog 100	E-7235	Catalog 100	E-7475	Catalog 700	E-7570	Catalog 700
E-6996	Catalog 100	E-7236	Catalog 100	E-7477	Catalog 700	E-7571	Catalog 700
E-6999S	Catalog 100	E-7237	Catalog 100	E-7478	Catalog 700	E-7572A	Catalog 700
E-6999SHD	Catalog 100	E-7238	Catalog 100	E-7479	Catalog 700	E-7579	Catalog 700
E-6999SHD-R	Catalog 100	E-7241	Catalog 100	E-7480	Catalog 700	E-7580	Catalog 700
E-6999S-R	Catalog 100	E-7258	Catalog 200	E-7481	Catalog 700	E-7581	Catalog 700
E-7015	Catalog 200	E-7260	Catalog 200	E-7482	Catalog 700	E-7582	Catalog 700
E-7016	Catalog 200	E-7371	Catalog 200	E-7483	Catalog 700	E-7583	Catalog 700
E-7016-30	Catalog 100	E-7382	Catalog 200	E-7484	Catalog 700	E-7584	Catalog 700
E-7017	Catalog 100	E-7383	Catalog 200	E-7485	Catalog 700	E-7599	Catalog 700
E-7024	Catalog 100	E-7385	Catalog 200	E-7486	Catalog 700	E-7600	Catalog 700
E-7025	Catalog 100	E-7400	Catalog 200	E-7487	Catalog 700	E-7601	Catalog 700
E-7026	Catalog 100	E-7401	Catalog 200	E-7488	Catalog 700	E-7602	Catalog 700
E-7031	Catalog 100	E-7402	Catalog 200	E-7489	Catalog 700	E-7603	Catalog 700
E-7033	Catalog 100	E-7406	Catalog 100	E-7491	Catalog 700	E-7604	Catalog 700

MASTER PART NUMBER INDEX

Part No	Page	Part No	Page	Part No	Page	Part No	Page
E-7605	Catalog 700	E-7686	Catalog 700	E-7781	Catalog 200	E-7867	Catalog 700
E-7606	Catalog 700	E-7687	Catalog 700	E-7783	Catalog 200	E-7868	Catalog 700
E-7607	Catalog 700	E-7688	Catalog 700	E-7785	Catalog 200	E-7869	Catalog 700
E-7608	Catalog 700	E-7689	Catalog 700	E-7786	Catalog 200	E-7870	Catalog 700
E-7609	Catalog 700	E-7690	Catalog 700	E-7787	Catalog 200	E-7871	Catalog 700
E-7610	Catalog 700	E-7691	Catalog 700	E-7788	Catalog 200	E-7879	Catalog 700
E-7611	Catalog 700	E-7692	Catalog 700	E-7789	Catalog 200	E-7887	Catalog 700
E-7612	Catalog 700	E-7693	Catalog 700	E-7790	Catalog 200	E-7895-L	Catalog 100
E-7613	Catalog 700	E-7694	Catalog 700	E-7791	Catalog 200	E-7895-L-PL	Catalog 100
E-7614	Catalog 700	E-7695	Catalog 700	E-7792	Catalog 200	E-7895-R	Catalog 100
E-7615	Catalog 700	E-7696	Catalog 700	E-7793	Catalog 200	E-7895-R-PL	Catalog 100
E-7616	Catalog 700	E-7697	Catalog 700	E-7794	Catalog 200	E-7896-L	Catalog 100
E-7617	Catalog 700	E-7698	Catalog 700	E-7795	Catalog 200	E-7896-L-PL	Catalog 100
E-7618	Catalog 700	E-7699	Catalog 700	E-7796	Catalog 200	E-7896-R	Catalog 100
E-7619	Catalog 700	E-7700	Catalog 700	E-7797	Catalog 200	E-7896-R-PL	Catalog 100
E-7620	Catalog 700	E-7701	Catalog 700	E-7798	Catalog 200	E-7897-L	Catalog 100
E-7621	Catalog 700	E-7702	Catalog 700	E-7799	Catalog 200	E-7897-R	Catalog 100
E-7622	Catalog 700	E-7703	Catalog 700	E-7800	Catalog 200	E-7898-L	Catalog 100
E-7623	Catalog 700	E-7704	Catalog 700	E-7801	Catalog 200	E-7898-R	Catalog 100
E-7624	Catalog 700	E-7706	Catalog 700	E-7802	Catalog 200	E-7899	Catalog 100
E-7625	Catalog 700	E-7707	Catalog 700	E-7803	Catalog 200	E-7900	Catalog 100
E-7626	Catalog 700	E-7709	Catalog 700	E-7804	Catalog 200	E-7901	Catalog 100
E-7627	Catalog 700	E-7710	Catalog 700	E-7805	Catalog 200	E-7902	Catalog 100
E-7628	Catalog 700	E-7712	Catalog 700	E-7806	Catalog 200	E-7903	Catalog 100
E-7629	Catalog 700	E-7713	Catalog 700	E-7807	Catalog 200	E-7904	Catalog 100
E-7630	Catalog 700	E77-1308	Catalog 100	E-7808	Catalog 200	E-7905	Catalog 100
E-7631	Catalog 700	E77-1308T	Catalog 100	E-7809	Catalog 200	E-7909	Catalog 100
E-7632	Catalog 700	E-7716	Catalog 700	E-7811	Catalog 200	E-7910	Catalog 100
E-7633	Catalog 700	E-7717	Catalog 700	E-7814	Catalog 200	E-7911	Catalog 100
E-7634	Catalog 700	E-7719	Catalog 700	E-7815	Catalog 200	E-7912	Catalog 100
E-7635	Catalog 700	E-7721	Catalog 700	E-7818	Catalog 200	E-7913	Catalog 100
E-7636	Catalog 700	E-7727	Catalog 700	E-7822	Catalog 200	E-7914	Catalog 100
E-7637	Catalog 700	E-7739	Catalog 700	E-7823	Catalog 200	E-7915	Catalog 100
E-7638	Catalog 700	E-7741	Catalog 700	E-7824	Catalog 200	E-7916	Catalog 100
E-7639	Catalog 700	E-7742	Catalog 700	E-7825	Catalog 200	E-7917	Catalog 100
E-7640	Catalog 700	E-7743	Catalog 700	E-7826	Catalog 200	E-7918	Catalog 700
E-7641	Catalog 700	E-7744	Catalog 700	E-7827	Catalog 200	E-7921	Catalog 200
E-7643	Catalog 700	E-7746	Catalog 700	E-7828	Catalog 200	E-7922	Catalog 200
E-7644	Catalog 700	E-7748	Catalog 700	E-7829	Catalog 200	E-7923	Catalog 200
E-7645	Catalog 700	E-7749	Catalog 700	E-7830	Catalog 200	E-7924	Catalog 200
E-7647	Catalog 100	E-7750	Catalog 700	E-7831	Catalog 200	E-7925	Catalog 200
E-7648	Catalog 100	E-7752	Catalog 700	E-7832	Catalog 200	E-7926	Catalog 200
E-7649	Catalog 100	E-7754	Catalog 700	E-7833	Catalog 200	E-7927	Catalog 200
E-7650	Catalog 100	E-7755	Catalog 700	E-7834	Catalog 200	E-7928	Catalog 200
E-7651	Catalog 100	E-7756	Catalog 700	E-7835	Catalog 200	E-7929	Catalog 200
E-7652	Catalog 100	E-7757	Catalog 700	E-7836	Catalog 200	E-7930	Catalog 200
E-7653	Catalog 100	E-7758	Catalog 700	E-7837	Catalog 200	E-7931	Catalog 200
E-7654	Catalog 100	E-7763	Catalog 700	E-7838	Catalog 200	E-7932	Catalog 200
E-7655	Catalog 100	E-7764	Catalog 700	E-7839	Catalog 200	E-7933	Catalog 200
E-7656	Catalog 100	E-7765	Catalog 700	E-7840	Catalog 700	E-7934	Catalog 200
E-7657	Catalog 100	E-7766	Catalog 700	E-7841	Catalog 700	E-7936	Catalog 200
E-7658	Catalog 100	E-7767	Catalog 700	E-7844	Catalog 700	E-7937	Catalog 200
E-7659	Catalog 100	E-7768	Catalog 700	E-7845	Catalog 700	E-7938	Catalog 200
E-7660	Catalog 100	E-7769	Catalog 700	E-7846	Catalog 700	E-7939	Catalog 200
E-7662	Catalog 100	E-7770	Catalog 700	E-7851	Catalog 700	E-7940	Catalog 200
E-7663	Catalog 100	E-7771	Catalog 700	E-7852	Catalog 700	E-7941	Catalog 200
E-7664	Catalog 100	E-7772	Catalog 700	E-7853	Catalog 700	E-7942	Catalog 200
E-7665	Catalog 100	E-7773	Catalog 700	E-7854	Catalog 700	E-7943	Catalog 200
E-7666	Catalog 100	E-7774	Catalog 700	E-7855	Catalog 700	E-7944	Catalog 200
E-7681	Catalog 700	E-7775	Catalog 100	E-7862	Catalog 700	E-7945	Catalog 200
E-7682	Catalog 700	E-7776	Catalog 200	E-7863	Catalog 700	E-7946	Catalog 200
E-7683	Catalog 700	E-7777	Catalog 200	E-7864	Catalog 700	E-7948	Catalog 200
E-7684	Catalog 700	E-7778	Catalog 200	E-7865	Catalog 700	E-7949	Catalog 200
E-7685	Catalog 700	E-7779	Catalog 200	E-7866	Catalog 700	E-7950	Catalog 200

MASTER PART NUMBER INDEX

Part No	Page	Part No	Page	Part No	Page	Part No	Page
E-8579-18	Catalog 100	E-8581-20	Catalog 100	E-8583-14	Catalog 100	E-8598	Catalog 100
E-8579-20	Catalog 100	E-8581-22	Catalog 100	E-8583-16	Catalog 100	E-8599	Catalog 100
E-8579-20-BK	Catalog 100	E-8581-24	Catalog 100	E-8583-18	Catalog 100	E-8600	Catalog 100
E-8579-22	Catalog 100	E-8581-26	Catalog 100	E-8583-20	Catalog 100	E-8601	Catalog 100
E-8579-24	Catalog 100	E-8581-28	Catalog 100	E-8583-22	Catalog 100	E-8602	Catalog 100
E-8579-24-BK	Catalog 100	E-8581-30	Catalog 100	E-8583-24	Catalog 100	E-8603	Catalog 100
E-8579-26	Catalog 100	E-8581-32	Catalog 100	E-8583-26	Catalog 100	E-8604	Catalog 100
E-8579-26-BK	Catalog 100	E-8581-34	Catalog 100	E-8583-28	Catalog 100	E-8605	Catalog 100
E-8579-28	Catalog 100	E-8581-36	Catalog 100	E-8583-30	Catalog 100	E-8606	Catalog 100
E-8579-28-BK	Catalog 100	E-8581-38	Catalog 100	E-8583-32	Catalog 100	E-8607	Catalog 100
E-8579-30	Catalog 100	E-8581-40	Catalog 100	E-8583-34	Catalog 100	E-8608	Catalog 100
E-8579-30-BK	Catalog 100	E-8581-42	Catalog 100	E-8583-36	Catalog 100	E-8609	Catalog 100
E-8579-32	Catalog 100	E-8581-44	Catalog 100	E-8583-38	Catalog 100	E-8610	Catalog 100
E-8579-34	Catalog 100	E-8581-48	Catalog 100	E-8583-40	Catalog 100	E-8611	Catalog 100
E-8579-36	Catalog 100	E-8581-50	Catalog 100	E-8583-42	Catalog 100	E-8612	Catalog 100
E-8579-36-BK	Catalog 100	E-8581-52	Catalog 100	E-8583-44	Catalog 100	E-8613	Catalog 100
E-8579-38	Catalog 100	E-8581-56	Catalog 100	E-8583-46	Catalog 100	E-8614	Catalog 100
E-8579-40	Catalog 100	E-8581-60	Catalog 100	E-8583-48	Catalog 100	E-8615	Catalog 100
E-8579-42	Catalog 100	E-8581-66	Catalog 100	E-8583-50	Catalog 100	E-8616	Catalog 100
E-8579-44	Catalog 100	E-8581-72	Catalog 100	E-8583-52	Catalog 100	E-8617	Catalog 100
E-8579-46	Catalog 100	E-8581-84	Catalog 100	E-8583-56	Catalog 100	E-8618	Catalog 100
E-8579-50	Catalog 100	E-8582-08	Catalog 100	E-8583-60	Catalog 100	E-8619	Catalog 100
E-8579-54	Catalog 100	E-8582-12	Catalog 100	E-8583-66	Catalog 100	E-8620	Catalog 100
E-8579-60	Catalog 100	E-8582-14	Catalog 100	E-8583-72	Catalog 100	E-8621	Catalog 100
E-8579-66	Catalog 100	E-8582-16	Catalog 100	E-8583-84	Catalog 100	E-8622	Catalog 100
E-8579-72	Catalog 100	E-8582-18	Catalog 100	E-8584-08	Catalog 100	E-8623	Catalog 100
E-8579-84	Catalog 100	E-8582-18-BK	Catalog 100	E-8584-12	Catalog 100	E-8624	Catalog 100
E-8580-08	Catalog 100	E-8582-20	Catalog 100	E-8584-14	Catalog 100	E-8625	Catalog 100
E-8580-12	Catalog 100	E-8582-20-BK	Catalog 100	E-8584-16	Catalog 100	E-8626	Catalog 100
E-8580-14	Catalog 100	E-8582-22	Catalog 100	E-8584-18	Catalog 100	E-8627	Catalog 100
E-8580-16	Catalog 100	E-8582-22-BK	Catalog 100	E-8584-20	Catalog 100	E-8629	Catalog 200
E-8580-18	Catalog 100	E-8582-24	Catalog 100	E-8584-22	Catalog 100	E-8630	Catalog 200
E-8580-20	Catalog 100	E-8582-24-BK	Catalog 100	E-8584-24	Catalog 100	E-8631	Catalog 200
E-8580-20-BK	Catalog 100	E-8582-26	Catalog 100	E-8584-26	Catalog 100	E-8632	Catalog 200
E-8580-22	Catalog 100	E-8582-26-BK	Catalog 100	E-8584-28	Catalog 100	E-8633	Catalog 200
E-8580-24	Catalog 100	E-8582-28	Catalog 100	E-8584-30	Catalog 100	E-8634	Catalog 200
E-8580-24-BK	Catalog 100	E-8582-28-BK	Catalog 100	E-8584-32	Catalog 100	E-8635	Catalog 200
E-8580-26	Catalog 100	E-8582-30	Catalog 100	E-8584-34	Catalog 100	E-8636	Catalog 200
E-8580-26-BK	Catalog 100	E-8582-30-BK	Catalog 100	E-8584-36	Catalog 100	E-8637	Catalog 200
E-8580-28	Catalog 100	E-8582-32	Catalog 100	E-8584-38	Catalog 100	E-8639	Catalog 200
E-8580-28-BK	Catalog 100	E-8582-32-BK	Catalog 100	E-8584-40	Catalog 100	E-8640	Catalog 200
E-8580-30	Catalog 100	E-8582-34	Catalog 100	E-8584-42	Catalog 100	E-8641	Catalog 200
E-8580-30-BK	Catalog 100	E-8582-34-BK	Catalog 100	E-8584-44	Catalog 100	E-8642	Catalog 200
E-8580-32	Catalog 100	E-8582-36	Catalog 100	E-8584-46	Catalog 100	E-8643	Catalog 200
E-8580-34	Catalog 100	E-8582-36-BK	Catalog 100	E-8584-48	Catalog 100	E-8644	Catalog 200
E-8580-36	Catalog 100	E-8582-38	Catalog 100	E-8584-50	Catalog 100	E-8645	Catalog 200
E-8580-36-BK	Catalog 100	E-8582-40	Catalog 100	E-8584-56	Catalog 100	E-8646	Catalog 200
E-8580-38	Catalog 100	E-8582-42	Catalog 100	E-8584-60	Catalog 100	E-8650	Catalog 700
E-8580-40	Catalog 100	E-8582-42-BK	Catalog 100	E-8584-66	Catalog 100	E-8651	Catalog 700
E-8580-42	Catalog 100	E-8582-44	Catalog 100	E-8584-72	Catalog 100	E-8652	Catalog 700
E-8580-44	Catalog 100	E-8582-46	Catalog 100	E-8584-84	Catalog 100	E-8653	Catalog 700
E-8580-46	Catalog 100	E-8582-48	Catalog 100	E-8585	Catalog 100	E-8654	Catalog 700
E-8580-50	Catalog 100	E-8582-48-BK	Catalog 100	E-8586	Catalog 100	E-8655	Catalog 700
E-8580-54	Catalog 100	E-8582-50	Catalog 100	E-8587	Catalog 100	E-8656	Catalog 700
E-8580-60	Catalog 100	E-8582-52	Catalog 100	E-8588	Catalog 100	E-8663	Catalog 700
E-8580-66	Catalog 100	E-8582-56	Catalog 100	E-8589	Catalog 100	E-8664	Catalog 700
E-8580-68	Catalog 100	E-8582-60	Catalog 100	E-8590	Catalog 100	E-8665	Catalog 700
E-8580-72	Catalog 100	E-8582-62	Catalog 100	E-8591	Catalog 100	E-8666	Catalog 700
E-8580-84	Catalog 100	E-8582-66	Catalog 100	E-8592	Catalog 100	E-8667	Catalog 700
E-8581-08	Catalog 100	E-8582-68	Catalog 100	E-8593	Catalog 100	E-8669	Catalog 700
E-8581-12	Catalog 100	E-8582-72	Catalog 100	E-8594	Catalog 100	E-8670	Catalog 700
E-8581-14	Catalog 100	E-8582-84	Catalog 100	E-8595	Catalog 100	E-8671	Catalog 700
E-8581-16	Catalog 100	E-8583-08	Catalog 100	E-8596	Catalog 100	E-8672	Catalog 700
E-8581-18	Catalog 100	E-8583-12	Catalog 100	E-8597	Catalog 100	E-8673	Catalog 700

MASTER PART NUMBER INDEX

Part No	Page	Part No	Page	Part No	Page	Part No	Page
E-8674	Catalog 700	E-8840	Catalog 700	E-8926	Catalog 700	E-8986	Catalog 100
E-8676	Catalog 700	E-8841	Catalog 700	E-8927	Catalog 700	E-8987	Catalog 100
E-8677	Catalog 700	E-8844	Catalog 700	E-8929A	Catalog 700	E-8988	Catalog 100
E-8678	Catalog 700	E-8850	Catalog 700	E-8930A	Catalog 700	E-8990-L	Catalog 100
E-8679	Catalog 700	E-8851	Catalog 700	E-8931	Catalog 700	E-8990-R	Catalog 100
E-8680	Catalog 700	E-8852	Catalog 700	E-8932	Catalog 200	E-8992-L	Catalog 100
E-8681	Catalog 700	E-8853	Catalog 700	E-8936	Catalog 100	E-8992-R	Catalog 100
E-8682	Catalog 700	E-8853A	Catalog 700	E-8937	Catalog 100	E-8993-L	Catalog 100
E-8683	Catalog 700	E-8854	Catalog 700	E-8938	Catalog 100	E-8993-R	Catalog 100
E-8684	Catalog 700	E-8855	Catalog 700	E-8941	Catalog 700	E-8994-L	Catalog 100
E-8688	Catalog 700	E-8858	Catalog 200	E-8946-L	Catalog 100	E-8994-R	Catalog 100
E-8689	Catalog 700	E-8859	Catalog 200	E-8946-R	Catalog 100	E-8995-L	Catalog 100
E-8691	Catalog 700	E-8860	Catalog 200	E-8947-L	Catalog 100	E-8995-R	Catalog 100
E-8692	Catalog 200	E-8861	Catalog 200	E-8947-R	Catalog 100	E-8996-L	Catalog 100
E-8695	Catalog 200	E-8866	Catalog 200	E-8948-L	Catalog 100	E-8996-R	Catalog 100
E-8696	Catalog 200	E-8867	Catalog 200	E-8948-R	Catalog 100	E-8997	Catalog 100
E-8698	Catalog 200	E-8874	Catalog 200	E-8949-L	Catalog 100	E-9000-L	Catalog 100
E-8699	Catalog 200	E-8875	Catalog 200	E-8949-R	Catalog 100	E-9000-R	Catalog 100
E-8700	Catalog 200	E-8876	Catalog 200	E-8950-L	Catalog 100	E-9001-L	Catalog 100
E-8701	Catalog 700	E-8877	Catalog 200	E-8950-R	Catalog 100	E-9001-R	Catalog 100
E-8702	Catalog 700	E-8878	Catalog 200	E-8951-L	Catalog 100	E-9002-L	Catalog 100
E-8703	Catalog 100	E-8879	Catalog 200	E-8951-R	Catalog 100	E-9002-R	Catalog 100
E-8732	11-14,11-111	E-8881	Catalog 200	E-8952-L	Catalog 100	E-9003-L	Catalog 100
E-8757	11-9,11-23, 11-61,11-107, 11-109,11-110, 11-111,11-112, 11-176,11-180, 11-181,11-182, 11-183,11-185	E-8882	Catalog 200	E-8952-R	Catalog 100	E-9003-R	Catalog 100
		E-8883	Catalog 200	E-8954-L	Catalog 100	E-9004-L	Catalog 100
		E-8884	Catalog 200	E-8954-R	Catalog 100	E-9004-R	Catalog 100
		E-8885	Catalog 200	E-8955-L	Catalog 100	E-9005-L	Catalog 100
		E-8886	Catalog 200	E-8955-R	Catalog 100	E-9005-R	Catalog 100
		E-8887	Catalog 200	E-8957-L	Catalog 100	E-9006	Catalog 100
		E-8888	Catalog 100	E-8957-R	Catalog 100	E-9007	Catalog 100
E-8758	11-9,11-23, 11-61,11-107, 11-109,11-110, 11-111,11-112, 11-176,11-180, 11-181,11-182, 11-183,11-185	E-8889	Catalog 100	E-8958-L	Catalog 100	E-9008-L	Catalog 100
		E-8890	Catalog 100	E-8958-R	Catalog 100	E-9008-R	Catalog 100
		E-8891	Catalog 100	E-8959-L	Catalog 100	E-9009	Catalog 100
		E-8892	Catalog 100	E-8959-R	Catalog 100	E-9010-L	Catalog 100
		E-8893	Catalog 100	E-8960	Catalog 100	E-9010-R	Catalog 100
		E-8894	Catalog 100	E-8961	Catalog 100	E-9011-L	Catalog 100
		E-8895	Catalog 100	E-8962	Catalog 100	E-9011-R	Catalog 100
E-8795	Catalog 700	E-8896	Catalog 100	E-8963	Catalog 100	E-9012-L	Catalog 100
E-8796	Catalog 700	E-8897	Catalog 100	E-8964	Catalog 100	E-9012-R	Catalog 100
E-8797	Catalog 700	E-8898	Catalog 100	E-8965	Catalog 100	E-9020	Catalog 100
E-8798	Catalog 700	E-8899	Catalog 100	E-8966-L	Catalog 100	E-9021	Catalog 100
E-8799	Catalog 700	E-8900	Catalog 100	E-8966-R	Catalog 100	E-9022-R	Catalog 100
E-8800	Catalog 700	E-8901	Catalog 100	E-8968-L	Catalog 100	E-9023	Catalog 100
E-8802	Catalog 700	E-8902	Catalog 200	E-8968-R	Catalog 100	E-9024	Catalog 100
E-8803	Catalog 700	E-8903	Catalog 200	E-8969-L	Catalog 100	E-9025	Catalog 100
E-8804	Catalog 700	E-8904	Catalog 200	E-8969-R	Catalog 100	E-9026	Catalog 100
E-8805	Catalog 700	E-8905	Catalog 200	E-8972-L	Catalog 100	E-9027	Catalog 100
E-8806	Catalog 700	E-8906	Catalog 100	E-8972-R	Catalog 100	E-9027-78	Catalog 100
E-8808	Catalog 700	E-8907	Catalog 100	E-8976-L	Catalog 100	E-9028	Catalog 100
E-8809	Catalog 700	E-8909	Catalog 700	E-8976-R	Catalog 100	E-9029	Catalog 100
E-8810	Catalog 700	E-8910	Catalog 700	E-8977-L	Catalog 100	E-9030	Catalog 100
E-8818	Catalog 700	E-8911	Catalog 700	E-8977-R	Catalog 100	E-9031	Catalog 100
E-8819	Catalog 700	E-8912	Catalog 700	E-8978-L	Catalog 100	E-9032	Catalog 100
E-8821	Catalog 700	E-8917	Catalog 700	E-8978-R	Catalog 100	E-9033	Catalog 100
E-8830	Catalog 700	E-8918	Catalog 700	E-8979-L	Catalog 100	E-9034	Catalog 100
E-8831	Catalog 700	E-8919	Catalog 700	E-8979-R	Catalog 100	E-9035	Catalog 100
E-8832	Catalog 700	E-8920	Catalog 700	E-8980	Catalog 100	E-9036	Catalog 100
E-8833	Catalog 700	E-8921	Catalog 200	E-8981	Catalog 100	E-9037	Catalog 100
E-8834	Catalog 700	E-8922	Catalog 100	E-8982-L	Catalog 100	E-9038	Catalog 100
E-8835	Catalog 700	E-8922-78	Catalog 100	E-8982-R	Catalog 100	E-9039	Catalog 100
E-8836	Catalog 700	E-8922-88	Catalog 100	E-8983-L	Catalog 100	E-9040	Catalog 100
E-8837	Catalog 700	E-8923	Catalog 100	E-8983-R	Catalog 100	E-9041	Catalog 100
E-8838	Catalog 700	E-8924	Catalog 100	E-8985-L	Catalog 100	E-9042	Catalog 100
E-8839	Catalog 700	E-8925	Catalog 100	E-8985-R	Catalog 100	E-9043	Catalog 100

MASTER PART NUMBER INDEX

Part No	Page	Part No	Page	Part No	Page	Part No	Page
E-9044	Catalog 100	E-9111	Catalog 100	E-9173X	Catalog 200	E-9240	Catalog 200
E-9045	Catalog 100	E-9112	Catalog 100	E-9174X	Catalog 200	E-9241	Catalog 200
E-9046	Catalog 100	E-9113	Catalog 100	E-9175X	Catalog 200	E-9242	Catalog 200
E-9047	Catalog 100	E-9114	Catalog 100	E-9176X	Catalog 200	E-9243	Catalog 200
E-9048	Catalog 100	E-9115	Catalog 100	E-9177X	Catalog 200	E-9244	Catalog 200
E-9049	Catalog 100	E-9116	Catalog 100	E-9178X	Catalog 200	E-9245	Catalog 200
E-9052	Catalog 100	E-9117	Catalog 100	E-9179X	Catalog 200	E-9246	Catalog 200
E-9053	Catalog 100	E-9118	Catalog 100	E-9180X	Catalog 200	E-9247	Catalog 200
E-9054	Catalog 100	E-9119	Catalog 100	E-9181X	Catalog 200	E-9248	Catalog 200
E-9055	Catalog 100	E-9120	Catalog 100	E-9181X-SL	Catalog 200	E-9249	Catalog 200
E-9056	Catalog 100	E-9121	Catalog 100	E-9182X	Catalog 200	E-9250	Catalog 200
E-9057	Catalog 100	E-9122	Catalog 100	E-9182X-SL	Catalog 200	E-9251	Catalog 200
E-9058	Catalog 100	E-9123	Catalog 100	E-9183X	Catalog 200	E-9252	Catalog 200
E-9059	Catalog 100	E-9124	Catalog 100	E-9184X	Catalog 200	E-9253	Catalog 200
E-9060	Catalog 100	E-9125	Catalog 100	E-9185X	Catalog 200	E-9254	Catalog 200
E-9061	Catalog 100	E-9126	Catalog 100	E-9186X	Catalog 200	E-9255	Catalog 200
E-9062	Catalog 100	E-9127	Catalog 100	E-9187X	Catalog 200	E-9256	Catalog 200
E-9062-78	Catalog 100	E-9128	Catalog 100	E-9188X	Catalog 200	E-9257	Catalog 200
E-9063	Catalog 100	E-9130	Catalog 100	E-9189X	Catalog 200	E-9258	Catalog 200
E-9064	Catalog 100	E-9131	Catalog 100	E-9190X	Catalog 200	E-9259	Catalog 200
E-9065	Catalog 100	E-9132	Catalog 100	E-9191X	Catalog 200	E-9261	Catalog 100
E-9066	Catalog 100	E-9133	Catalog 100	E-9192X	Catalog 200	E-9262	Catalog 100
E-9067A	Catalog 100	E-9134	Catalog 100	E-9193X	Catalog 200	E-9262-PL	Catalog 100
E-9068A	Catalog 100	E-9135	Catalog 100	E-9194X	Catalog 200	E-9263	Catalog 100
E-9069	Catalog 100	E-9136	Catalog 100	E-9195X	Catalog 200	E-9264	Catalog 100
E-9070	Catalog 100	E-9137	Catalog 100	E-9196X	Catalog 200	E-9265	Catalog 100
E-9071	Catalog 100	E-9138	Catalog 100	E-9197X	Catalog 200	E-9266	Catalog 100
E-9072	Catalog 100	E-9139	Catalog 100	E-9198X	Catalog 200	E-9267	Catalog 100
E-9073	Catalog 100	E-913X	Catalog 100	E-9199X	Catalog 200	E-9268	Catalog 100
E-9074	Catalog 100	E-9140	Catalog 100	E-9200X	Catalog 200	E-9269	Catalog 100
E-9075	Catalog 100	E-9141	Catalog 100	E-9201X	Catalog 200	E-9270	Catalog 100
E-9076	Catalog 100	E-9142	Catalog 100	E-9203X	Catalog 200	E-9271	Catalog 100
E-9077	Catalog 100	E-9143X	Catalog 200	E-9205X	Catalog 200	E-9272	Catalog 100
E-9078	Catalog 100	E-9144X	Catalog 200	E-9206X	Catalog 200	E-9273	Catalog 100
E-9078HD	Catalog 100	E-9145X	Catalog 200	E-9207X	Catalog 200	E-9274	Catalog 100
E-9078HD-2	Catalog 100	E-9146X	Catalog 200	E-9208X	Catalog 200	E-9275	Catalog 100
E-9079	Catalog 100	E-9147X	Catalog 200	E-9209X	Catalog 200	E-9276	Catalog 100
E-9079HD	Catalog 100	E-9148X	Catalog 200	E-9210X	Catalog 200	E-9277	Catalog 100
E-9079HD-2	Catalog 100	E-9149X	Catalog 200	E-9211X	Catalog 200	E-9278	Catalog 100
E-9080	Catalog 100	E-9150X	Catalog 200	E-9212X	Catalog 200	E-9279	Catalog 100
E-9087	Catalog 100	E-9151X	Catalog 200	E-9213X	Catalog 200	E-9280	Catalog 100
E-9088	Catalog 100	E-9152X	Catalog 200	E-9214X	Catalog 200	E-9281	Catalog 100
E-9089	Catalog 100	E-9153X	Catalog 200	E-9215X	Catalog 200	E-9282	Catalog 100
E-9090	Catalog 100	E-9154X	Catalog 200	E-9216X	Catalog 200	E-9283	Catalog 100
E-9095A	Catalog 100	E-9155X	Catalog 200	E-9217X	Catalog 200	E-9284	Catalog 700
E-9095AHD	Catalog 100	E-9156X	Catalog 200	E-9218X	Catalog 200	E-9286	Catalog 700
E-9096	Catalog 100	E-9157X	Catalog 200	E-9220	11-7	E-9287	Catalog 700
E-9097	Catalog 100	E-9158X	Catalog 200	E-9221	11-7	E-9288	Catalog 700
E-9098	Catalog 100	E-9159X	Catalog 200	E-9222	Catalog 200	E-9289	Catalog 700
E-9099	Catalog 100	E-9160X	Catalog 200	E-9223	Catalog 200	E-9290	Catalog 700
E-9100	Catalog 100	E-9161X	Catalog 200	E-9224	Catalog 200	E-9291	Catalog 700
E-9101	Catalog 100	E-9162X	Catalog 200	E-9226	Catalog 200	E-9292	Catalog 700
E-9102	Catalog 100	E-9163X	Catalog 200	E-9227	Catalog 200	E-9293	Catalog 700
E-9103	Catalog 100	E-9164X	Catalog 200	E-9228	Catalog 200	E-9294	Catalog 700
E-9104	Catalog 100	E-9165X	Catalog 200	E-9229	Catalog 200	E-9295	Catalog 700
E-9105	Catalog 100	E-9166X	Catalog 200	E-9231	Catalog 200	E-9296	Catalog 700
E-9106	Catalog 100	E-9167X	Catalog 200	E-9232	Catalog 200	E-9297	Catalog 700
E-9107	Catalog 100	E-9168X	Catalog 200	E-9233	Catalog 200	E-9299	Catalog 700
E-9107U	Catalog 100	E-9169X	Catalog 200	E-9234	Catalog 200	E-9300	Catalog 700
E-9108	Catalog 100	E-9169X-SL	Catalog 200	E-9235	Catalog 200	E-9301	Catalog 700
E-9108U	Catalog 100	E-9170X	Catalog 200	E-9236	Catalog 200	E-9302	Catalog 700
E-9109	Catalog 100	E-9170X-SL	Catalog 200	E-9237	Catalog 200	E-9303	Catalog 700
E-9109U	Catalog 100	E-9171X	Catalog 200	E-9238	Catalog 200	E-9304	Catalog 700
E-9110	Catalog 100	E-9172X	Catalog 200	E-9239	Catalog 200	E-9305	Catalog 700

MASTER PART NUMBER INDEX

Part No	Page	Part No	Page	Part No	Page	Part No	Page
E-9307	Catalog 700	E-9402	Catalog 700	E-9477	Catalog 700	E-9553	Catalog 700
E-9308	Catalog 700	E-9403	Catalog 700	E-9478	Catalog 700	E-9554	Catalog 700
E-9309	Catalog 700	E-9404	Catalog 700	E-9479	Catalog 700	E-9555	Catalog 700
E-9310	Catalog 200	E-9405	Catalog 700	E-9480	Catalog 700	E-9557	Catalog 700
E-9312B	11-4, 11-5	E-9406	Catalog 700	E-9482	Catalog 700	E-9558	Catalog 700
E-9319	Catalog 100	E-9407	Catalog 700	E-9484	Catalog 700	E-9559	Catalog 700
E-9320	Catalog 100	E-9408	Catalog 700	E-9485	Catalog 700	E-9560	Catalog 700
E-9321	Catalog 700	E-9409	Catalog 700	E-9486	Catalog 700	E-9561	Catalog 700
E-9322	Catalog 700	E-9411	Catalog 700	E-9487	Catalog 700	E-9562	Catalog 700
E-9323	Catalog 700	E-9412	Catalog 700	E-9489	Catalog 700	E-9563	Catalog 700
E-9324	Catalog 700	E-9413	Catalog 700	E-9491	Catalog 700	E-9564	Catalog 700
E-9325	Catalog 700	E-9414	Catalog 700	E-9492	Catalog 700	E-9567	Catalog 700
E-9326	Catalog 700	E-9415	Catalog 700	E-9493	Catalog 700	E-9568	Catalog 100
E-9327	Catalog 700	E-9416	Catalog 700	E-9494	Catalog 700	E-9569	Catalog 100
E-9328	Catalog 700	E-9417	Catalog 700	E-9495	Catalog 700	E-9570	Catalog 700
E-9329	Catalog 700	E-9418	Catalog 700	E-9496	Catalog 700	E-9571	Catalog 700
E-9330	Catalog 700	E-9419	Catalog 700	E-9497	Catalog 700	E-9572	Catalog 700
E-9331	Catalog 200	E-9420	Catalog 700	E-9498	Catalog 700	E-9573	Catalog 700
E-9332	Catalog 200	E-9421	Catalog 700	E-9499	Catalog 700	E-9574	Catalog 700
E-9333	Catalog 200	E-9422X	Catalog 200	E-9500	Catalog 700	E-9575	Catalog 100
E-9334	Catalog 200	E-9423X	Catalog 200	E-9501	Catalog 700	E-9576	Catalog 700
E-9347	Catalog 100	E-9424X	Catalog 200	E-9502	Catalog 700	E-9577	Catalog 700
E-9348	Catalog 100	E-9425X	Catalog 200	E-9503	Catalog 700	E-9579	Catalog 700
E-9349	Catalog 100	E-9426	Catalog 700	E-9506	Catalog 700	E-9581	Catalog 700
E-9350	Catalog 700	E-9427	Catalog 700	E-9507	Catalog 700	E-9582	Catalog 700
E-9351	Catalog 700	E-9428	Catalog 700	E-9508	Catalog 700	E-9583	Catalog 700
E-9353	Catalog 700	E-9429	Catalog 700	E-9509	Catalog 100	E-9584	Catalog 700
E-9354	Catalog 700	E-9430	Catalog 700	E-9510	Catalog 700	E-9585	Catalog 700
E-9355	Catalog 700	E-9432	Catalog 700	E-9512A	Catalog 700	E-9586	Catalog 700
E-9358	Catalog 700	E-9433	Catalog 100	E-9513	Catalog 700	E-9587	Catalog 700
E-9359	Catalog 700	E-9434	Catalog 100	E-9514	Catalog 700	E-9588	Catalog 700
E-9361	Catalog 700	E-9435	Catalog 100	E-9515	Catalog 700	E-9590	Catalog 100
E-9362	Catalog 700	E-9436	Catalog 100	E-9517	Catalog 700	E-9591	Catalog 100
E-9363	Catalog 700	E-9437	Catalog 700	E-9518	Catalog 700	E-9592	Catalog 100
E-9364	Catalog 700	E-9438	Catalog 700	E-9520	Catalog 700	E-9593	Catalog 100
E-9365	Catalog 700	E-9439	Catalog 700	E-9523-L	Catalog 100	E-9594	Catalog 100
E-9366	Catalog 700	E-9440	Catalog 700	E-9523-R	Catalog 100	E-9596	Catalog 100
E-9367	Catalog 700	E-9441A	Catalog 700	E-9524-L	Catalog 100	E-9597	Catalog 100
E-9368	Catalog 700	E-9442	Catalog 700	E-9524-R	Catalog 100	E-9598	Catalog 100
E-9370	Catalog 700	E-9443	Catalog 700	E-9525-L	Catalog 100	E-9599	Catalog 100
E-9372	Catalog 700	E-9444	Catalog 700	E-9525-R	Catalog 100	E-9600	Catalog 100
E-9373	Catalog 700	E-9445	Catalog 700	E-9526	Catalog 100	E-9601	Catalog 100
E-9374	Catalog 700	E-9446	Catalog 700	E-9527	Catalog 700	E-9602	Catalog 100
E-9375	Catalog 700	E-9447	Catalog 700	E-9528	Catalog 700	E-9603	Catalog 700
E-9376	Catalog 700	E-9448	Catalog 700	E-9529	Catalog 700	E-9604	Catalog 700
E-9377	Catalog 700	E-9449	Catalog 700	E-9530	Catalog 700	E-9605	Catalog 700
E-9378	Catalog 700	E-9450	Catalog 700	E-9531	Catalog 700	E-9606	Catalog 700
E-9379	Catalog 700	E-9452	Catalog 700	E-9532	Catalog 700	E-9607	Catalog 700
E-9380	Catalog 700	E-9454	Catalog 700	E-9533	Catalog 700	E-9610	Catalog 700
E-9381	Catalog 700	E-9455	Catalog 700	E-9534	Catalog 700	E-9611	Catalog 700
E-9384	Catalog 700	E-9456	Catalog 700	E-9535	Catalog 700	E-9612	Catalog 700
E-9385	Catalog 700	E-9457	Catalog 700	E-9536	Catalog 700	E-9613	Catalog 700
E-9386	Catalog 700	E-9458	Catalog 700	E-9537	Catalog 700	E-9614	Catalog 700
E-9387	Catalog 700	E-9459	Catalog 700	E-9538	Catalog 700	E-9615	Catalog 700
E-9389	Catalog 700	E-9460	Catalog 700	E-9539	Catalog 700	E-9616	Catalog 700
E-9390	Catalog 700	E-9461	Catalog 700	E-9541	Catalog 700	E-9617	Catalog 700
E-9391	Catalog 700	E-9469	Catalog 700	E-9543	Catalog 700	E-9618	Catalog 700
E-9392	Catalog 700	E-9470	Catalog 700	E-9544	Catalog 700	E-9619	Catalog 700
E-9393	Catalog 700	E-9471	Catalog 700	E-9545	Catalog 700	E-9620	Catalog 700
E-9394	Catalog 700	E-9472	Catalog 700	E-9548	Catalog 700	E-9622	Catalog 700
E-9395	Catalog 700	E-9473	Catalog 700	E-9549	Catalog 700	E-9623	Catalog 700
E-9397	Catalog 700	E-9474	Catalog 700	E-9550	Catalog 700	E-9624	Catalog 700
E-9400	Catalog 700	E-9475	Catalog 700	E-9551	Catalog 700	E-9625	Catalog 700
E-9401	Catalog 700	E-9476	Catalog 700	E-9552	Catalog 700	E-9626	Catalog 700

MASTER PART NUMBER INDEX

Part No	Page	Part No	Page	Part No	Page	Part No	Page
E-9627	Catalog 700	E-9693	Catalog 100	E-9763	Catalog 100	E-9846	Catalog 200
E-9628	Catalog 700	E-9694	Catalog 100	E-9764	Catalog 100	E-9847	Catalog 200
E-9629	Catalog 700	E-9695	Catalog 100	E-9765	Catalog 100	E-9848	Catalog 200
E-9630	Catalog 700	E-9696	Catalog 100	E-9766	Catalog 100	E-9849	Catalog 200
E-9631	Catalog 700	E-9697	Catalog 100	E-9767	Catalog 100	E-9850	Catalog 200
E-9632	Catalog 700	E-9698	Catalog 100	E-9768	Catalog 100	E-9851	Catalog 200
E-9633A	Catalog 700	E-9699	Catalog 100	E-9769	Catalog 100	E-9852	Catalog 200
E-9634A	Catalog 700	E-9700	Catalog 100	E-9770	Catalog 100	E-9853	Catalog 200
E-9635A	Catalog 700	E-9701	Catalog 100	E-9771	Catalog 100	E-9855	Catalog 200
E-9636	Catalog 700	E-9702	Catalog 100	E-9772	Catalog 100	E-9856	Catalog 200
E-9637	Catalog 700	E-9703	Catalog 100	E-9773	Catalog 100	E-9857	Catalog 200
E-9638	Catalog 700	E-9704	Catalog 100	E-9774	Catalog 100	E-9858	Catalog 200
E-9639	Catalog 700	E-9705	Catalog 100	E-9775	Catalog 100	E-9860	Catalog 200
E-9640	Catalog 700	E-9706	Catalog 100	E-9776	Catalog 100	E-9865	Catalog 200
E-9641	Catalog 700	E-9707	Catalog 100	E-9777	Catalog 100	E-9866	Catalog 200
E-9642	Catalog 700	E-9708	Catalog 100	E-9778	Catalog 100	E-9868	Catalog 100
E-9643	Catalog 100	E-9709	Catalog 100	E-9779	Catalog 100	E-9869	Catalog 700
E-9644	Catalog 100	E-9710	Catalog 100	E-9780	Catalog 100	E-9870	Catalog 200
E-9645	Catalog 100	E-9711	Catalog 100	E-9783	Catalog 100	E-9871	Catalog 200
E-9646	Catalog 100	E-9712	Catalog 100	E-9784	Catalog 100	E-9873	Catalog 200
E-9647	Catalog 100	E-9713	Catalog 100	E-9785A	Catalog 100	E-9874	Catalog 700
E-9648	Catalog 100	E-9714	Catalog 100	E-9786A	Catalog 100	E-9877	11-9,11-113, 11-115,11-116, 11-117,11-118, 11-119,11-120, 11-121,11-122, 11-123,11-124, 11-125,11-126, 11-127,11-191
E-9649	Catalog 100	E-9715	Catalog 100	E-9787A	Catalog 100	E-9878	11-9,11-115, 11-116,11-117, 11-118,11-119, 11-120,11-121, 11-122,11-123, 11-124,11-125, 11-126,11-127
E-9650	Catalog 100	E-9716	Catalog 100	E-9788A	Catalog 100	E-9879	11-9,11-115, 11-116,11-117, 11-118,11-119, 11-120,11-121, 11-122,11-123, 11-124,11-125, 11-126,11-127
E-9651	Catalog 100	E-9717	Catalog 100	E-9789	Catalog 100	E-9880	11-9,11-115, 11-116,11-117, 11-118,11-119, 11-120,11-121, 11-122,11-123, 11-125,11-126, 11-141,11-143, 11-162,11-164, 11-165,11-168
E-9652	Catalog 100	E-9718	Catalog 100	E-9790A	Catalog 100	E-9881	11-9,11-116, 11-117,11-118, 11-119,11-121, 11-122,11-123, 11-124,11-125, 11-126,11-127
E-9653	Catalog 100	E-9725	Catalog 100	E-9790A-2	Catalog 100	E-9882	Catalog 200
E-9654	Catalog 100	E-9726	Catalog 100	E-9791	Catalog 100	E-9883	Catalog 200
E-9655	Catalog 100	E-9727	Catalog 100	E-9791HD	Catalog 100	E-9884	Catalog 200
E-9656	Catalog 100	E-9728	Catalog 100	E-9792A	Catalog 100	E-9885	Catalog 200
E-9657	Catalog 100	E-9729	Catalog 100	E-9793	Catalog 100		
E-9658	Catalog 100	E-9730	Catalog 100	E-9801	Catalog 700		
E-9659	Catalog 100	E-9731	Catalog 100	E-9804	Catalog 200		
E-9660	Catalog 100	E-9732	Catalog 100	E-9805	Catalog 200		
E-9661	Catalog 100	E-9733	Catalog 100	E-9807	Catalog 200		
E-9662	Catalog 100	E-9734	Catalog 100	E-9808	Catalog 200		
E-9663	Catalog 100	E-9735	Catalog 100	E-9809	Catalog 200		
E-9664	Catalog 100	E-9736	Catalog 100	E-9811	Catalog 200		
E-9665	Catalog 100	E-9737	Catalog 100	E-9812	Catalog 200		
E-9666	Catalog 100	E-9738	Catalog 100	E-9813	Catalog 200		
E-9667	Catalog 100	E-9739	Catalog 100	E-9814	Catalog 200		
E-9668	Catalog 100	E-9740	Catalog 100	E-9815	Catalog 200		
E-9669	Catalog 100	E-9741	Catalog 100	E-9816	Catalog 200		
E-9670	Catalog 100	E-9742	Catalog 100	E-9817	Catalog 200		
E-9671	Catalog 100	E-9743	Catalog 100	E-9818	Catalog 200		
E-9672	Catalog 100	E-9744	Catalog 100	E-9819	Catalog 200		
E-9673A	Catalog 100	E-9745	Catalog 100	E-9822	Catalog 200		
E-9674A	Catalog 100	E-9746	Catalog 100	E-9823	Catalog 200		
E-9675	Catalog 100	E-9747	Catalog 100	E-9824	Catalog 100		
E-9676	Catalog 100	E-9748	Catalog 100	E-9825	Catalog 100		
E-9677	Catalog 100	E-9749	Catalog 100	E-9827	Catalog 100		
E-9678	Catalog 100	E-9750	Catalog 100	E-9828	Catalog 100		
E-9679	Catalog 100	E-9751	Catalog 100	E-9829	Catalog 100		
E-9680	Catalog 100	E-9752	Catalog 100	E-9830	Catalog 100		
E-9681	Catalog 100	E-9753	Catalog 100	E-9832	Catalog 100		
E-9682	Catalog 100	E-9754	Catalog 100	E-9837	Catalog 100		
E-9683	Catalog 100	E-9755	Catalog 100	E-9838	Catalog 700		
E-9684	Catalog 100	E-9756	Catalog 100	E-9839	Catalog 700		
E-9687A	Catalog 100	E-9757	Catalog 100	E-9840	Catalog 700		
E-9688A	Catalog 100	E-9758	Catalog 100	E-9841	Catalog 200		
E-9689A	Catalog 100	E-9759	Catalog 100	E-9842	Catalog 200		
E-9690A	Catalog 100	E-9760	Catalog 100	E-9843	Catalog 200		
E-9691A	Catalog 100	E-9761	Catalog 100	E-9844	Catalog 200		
E-9692A	Catalog 100	E-9762	Catalog 100	E-9845	Catalog 200		

MASTER PART NUMBER INDEX

Part No	Page	Part No	Page	Part No	Page	Part No	Page
E-9886	Catalog 200	E-9962 (cont)	11-29,11-33,	E-10104B (cont)	11-91,11-95,	E-10165N (cont)	11-182
E-9888	Catalog 200		11-34,11-37,		11-96,11-97,	E-10166N	11-4,11-179,
E-9889	Catalog 200		11-40,11-41,		11-98		11-180,11-181,
E-9890	Catalog 200		11-43,11-46,	E-10105B	11-4,11-66,		11-182,11-183
E-9897	11-14,11-62		11-47,11-50,		11-91,11-95,	E-10167	11-7
E-9911	11-12,11-141,	E-9963	11-51,11-53		11-96,11-97,	E-10168	11-7
	11-142,11-143,		11-9,11-26,		11-98	E-10169	11-7
	11-145,11-166		11-27,11-28,	E-10106B	11-4,11-66,	E-10170	11-7
E-9925	11-12,11-48,		11-33,11-34,		11-95,11-96,	E-10171	11-7
	11-49,11-52,		11-37,11-40,		11-97,11-98	E-10172	11-7
	11-53		11-41,11-43,	E-10108	11-8,11-66,	E-10173	11-7
E-9926	11-15,11-48,		11-46,11-47,		11-71,11-74,	E-10174	11-7
	11-52		11-50,11-51,		11-76,11-91,	E-10175	11-7
E-9927	11-15,11-48,		11-53		11-95,11-97,	E-10176	11-7
	11-49,11-52,	E-9964	11-16		11-98,11-99	E-10177	11-7
	11-53	E-9965	11-9,11-26,	E-10109	11-8,11-66,	E-10184	11-6
E-9929	11-14,11-53		11-27,11-28,		11-71,11-74,	E-10185	11-6
E-9931	11-15,11-34		11-29,11-33,		11-76,11-91,	E-10186	11-6
E-9933	11-12,11-48,		11-34,11-36,		11-95,11-97,	E-10187	11-6
	11-49,11-52,		11-37,11-40,		11-98,11-99	E-10188	11-6
	11-53		11-43,11-46,	E-10110	11-8,11-66,	E-10189	11-6
E-9934	11-14,11-27,		11-50,11-55		11-71,11-74,	E-10190	11-6
	11-30,11-38,	E-9966	11-9,11-26,		11-76,11-91,	E-10191	11-6
	11-41,11-44		11-27,11-28,		11-95,11-97,	E-10192	11-6
E-9936	11-14,11-27,		11-29,11-33,	E-10111	11-8,11-66,	E-10193	11-6
	11-30,11-38,		11-34,11-36,		11-71,11-74,	E-10194	11-6
	11-41,11-44		11-37,11-40,		11-71,11-74,	E-10195	11-6
E-9937	11-14,11-27,		11-43,11-46,		11-76,11-91,	E-10196	11-6
	11-30,11-38,		11-50,11-55		11-95,11-97,	E-10197	Catalog 100
	11-41,11-44	E-9967	11-8		11-98,11-99	E-10198	Catalog 100
E-9941B	11-4,11-5,	E-03009	Catalog 100	E-10112	11-8,11-66,	E-10199-L	Catalog 100
	11-20,11-141,	E-04000	Catalog 100		11-91	E-10199-R	Catalog 100
	11-142,11-143,	E-04000V	Catalog 100	E-10113	11-8,11-66,	E-10200-L	Catalog 100
	11-144,11-145,	E-04075	Catalog 100		11-91	E-10200-R	Catalog 100
	11-146	E-04075AH	Catalog 100	E-10114	11-8,11-116,	E-10201-L	Catalog 100
E-9942B	11-4,11-5,	E-04075H	Catalog 100		11-117,11-118,	E-10201-R	Catalog 100
	11-20,11-141,	E-04075V	Catalog 100		11-119,11-121,	E-10202-L	Catalog 100
	11-142,11-143,	E-05500	Catalog 100		11-122,11-123,	E-10202-R	Catalog 100
	11-144,11-145,	E-10057	Catalog 700		11-124,11-125,	E-10206-L	Catalog 100
	11-146	E-10058	Catalog 700		11-126,11-127	E-10206-R	Catalog 100
E-9943B	11-1,11-5,	E-10060	Catalog 700	E-10116	Catalog 700	E-10208-L	Catalog 100
	11-25,11-28,	E-10061	Catalog 700	E-10137	11-9,11-23,	E-10208-R	Catalog 100
	11-31,11-36,	E-10062	Catalog 700		11-61,11-107,	E-10209-L	Catalog 100
	11-38,11-39,	E-10063	Catalog 700		11-109,11-110,	E-10209-R	Catalog 100
	11-42	E-10064	Catalog 700		11-111,11-143,	E-10210-L	Catalog 100
E-9945B	11-3,11-5,	E-10065	Catalog 700		11-146,11-147,	E-10210-R	Catalog 100
	11-25,11-28,	E-10066	Catalog 700		11-164,11-176,	E-10213-L	Catalog 100
	11-31,11-36,	E-10067	Catalog 700		11-181	E-10213-R	Catalog 100
	11-39,11-42	E-10068	Catalog 700	E-10138	11-9,11-23,	E-10214-L	Catalog 100
E-9948	11-10,11-147,	E-10069	Catalog 700		11-61,11-107,	E-10214-R	Catalog 100
	11-149	E-10070	Catalog 700		11-109,11-110,	E-10215	Catalog 100
E-9951	11-9,11-145,	E-10071	Catalog 700		11-111,11-143,	E-10216	Catalog 100
	11-146,11-147,	E-10072	Catalog 700		11-146,11-147,	E-10217	Catalog 100
	11-149,11-165	E-10073	Catalog 700		11-164,11-176,	E-10218	Catalog 100
E-9952	11-9,11-145,	E-10092A	Catalog 100		11-181	E-10219	Catalog 100
	11-146,11-147,	E-10093A	Catalog 100	E-10158	Catalog 820	E-10220	Catalog 100
	11-149,11-165	E-10094A	Catalog 100	E-10163	11-8,11-179,	E-10221	Catalog 100
		E-10095A	Catalog 100		11-180,11-181,	E-10222	Catalog 100
E-9957	11-16	E-10096A	Catalog 100		11-182,11-183	E-10223	Catalog 100
E-9958	11-16	E-10097	Catalog 100	E-10164	11-8,11-179,	E-10224-L	Catalog 100
E-9959	11-16	E-10097G	Catalog 100		11-180,11-181,	E-10224-R	Catalog 100
E-9960	11-16	E-10098	Catalog 100		11-182,11-183	E-10225-L	Catalog 100
E-9961	11-16	E-10098G	Catalog 100	E-10165N	11-4,11-179,	E-10225-R	Catalog 100
E-9962	11-9,11-26,	E-10104B	11-2,11-66,		11-180,11-181,	E-10226-L	Catalog 100
	11-27,11-28,						

MASTER PART NUMBER INDEX

Part No	Page	Part No	Page	Part No	Page	Part No	Page
E-11293	Catalog 700	E-11428	Catalog 100	E-11545	Catalog 100	E-11611	Catalog 100
E-11294	Catalog 200	E-11429	Catalog 100	E-11546	Catalog 100	E-11612	Catalog 100
E-11296	Catalog 200	E-11430	Catalog 100	E-11547	Catalog 100	E-11613	Catalog 100
E-11297	Catalog 200	E-11432	Catalog 100	E-11548	Catalog 100	E-11614	Catalog 100
E-11302X	Catalog 200	E-11433	Catalog 100	E-11549	Catalog 100	E-11615	Catalog 100
E-11303X	Catalog 200	E-11434	Catalog 100	E-11550	Catalog 100	E-11618	Catalog 100
E-11304	Catalog 200	E-11436X	Catalog 200	E-11551	Catalog 100	E-11619	Catalog 100
E-11306	Catalog 200	E-11437X	Catalog 200	E-11552	Catalog 100	E-11620	Catalog 100
E-11307	Catalog 200	E-11438X	Catalog 200	E-11553	Catalog 100	E-11621	Catalog 100
E-11308	Catalog 200	E-11445	Catalog 100	E-11554	Catalog 100	E-11622	Catalog 100
E-11309	Catalog 200	E-11446	Catalog 100	E-11555	Catalog 100	E-11623	Catalog 100
E-11310	Catalog 200	E-11448	Catalog 700	E-11556	Catalog 100	E-11624	Catalog 100
E-11311	Catalog 200	E-11449	Catalog 100	E-11557	Catalog 100	E-11625	Catalog 100
E-11312	Catalog 200	E-11450	Catalog 100	E-11558	Catalog 100	E-11626	Catalog 100
E-11313	Catalog 200	E-11450HD	Catalog 100	E-11559	Catalog 100	E-11627	Catalog 100
E-11314	Catalog 200	E-11450HD-2	Catalog 100	E-11560	Catalog 100	E-11628	Catalog 100
E-11317	Catalog 200	E-11451	Catalog 100	E-11561	Catalog 100	E-11629	Catalog 100
E-11318	Catalog 100	E-11453	Catalog 100	E-11562	Catalog 100	E-11630	Catalog 100
E-11319	Catalog 100	E-11454	Catalog 100	E-11563	Catalog 100	E-11631	Catalog 100
E-11320	Catalog 200	E-11455	Catalog 100	E-11564	Catalog 100	E-11632	Catalog 100
E-11321	Catalog 200	E-11456	Catalog 100	E-11565	Catalog 100	E-11633	Catalog 100
E-11322	Catalog 200	E-11457	Catalog 100	E-11566	Catalog 100	E-11634	Catalog 100
E-11323	Catalog 200	E-11458	Catalog 100	E-11567	Catalog 100	E-11635	Catalog 100
E-11325	Catalog 200	E-11463	11-12,11-142, 11-143,11-161	E-11568	Catalog 100	E-11636	Catalog 100
E-11326	Catalog 200			E-11569	Catalog 100	E-11637	Catalog 100
E-11327	Catalog 200	E-11466	Catalog 200	E-11570	Catalog 100	E-11638	Catalog 100
E-11328	Catalog 200	E-11467	Catalog 200	E-11571	Catalog 100	E-11639	Catalog 100
E-11329	Catalog 200	E-1147C	Catalog 100	E-11572	Catalog 100	E-11640	Catalog 100
E-11394B	11-2,11-5, 11-23,11-143, 11-144	E-1148C	Catalog 100	E-11573	Catalog 100	E-11641	Catalog 100
		E-11491	Catalog 100	E-11574	Catalog 100	E-11642	Catalog 100
E-11395	Catalog 100	E-11493	Catalog 100	E-11575	Catalog 100	E-11643	Catalog 100
E-11396	Catalog 100	E-11512	Catalog 100	E-11576	Catalog 100	E-11646	Catalog 100
E-11397	Catalog 100	E-11513	Catalog 100	E-11577	Catalog 100	E-11647	Catalog 100
E-11398	Catalog 100	E-11514	Catalog 100	E-11578	Catalog 100	E-11649	Catalog 100
E-11399	Catalog 100	E-11515	Catalog 100	E-11579	Catalog 100	E-11650	Catalog 100
E-11400	Catalog 100	E-11516	Catalog 100	E-11580	Catalog 100	E-11651	Catalog 100
E-11401	Catalog 100	E-11517	Catalog 100	E-11581	Catalog 100	E-11652	Catalog 100
E-11402	Catalog 100	E-11518	Catalog 100	E-11582	Catalog 100	E-11661-L	Catalog 100
E-11403	Catalog 100	E-11519	Catalog 100	E-11583	Catalog 100	E-11661-R	Catalog 100
E-11404	Catalog 100	E-11520	Catalog 100	E-11584	Catalog 100	E-11672-L	Catalog 100
E-11405	Catalog 100	E-11521	Catalog 100	E-11585	Catalog 100	E-11672-R	Catalog 100
E-11406	Catalog 100	E-11522	Catalog 100	E-11586	Catalog 100	E-11703	Catalog 100
E-11407	Catalog 100	E-11523	Catalog 100	E-11587	Catalog 100	E-11706	Catalog 100
E-11408	Catalog 100	E-11524	Catalog 100	E-11588	Catalog 100	E-11707	Catalog 100
E-11409	Catalog 100	E-11525	Catalog 100	E-11589	Catalog 100	E-11710	Catalog 100
E-11410	Catalog 100	E-11526	Catalog 100	E-11590	Catalog 100	E-11715	Catalog 100
E-11411	Catalog 100	E-11527	Catalog 100	E-11591	Catalog 100	E-11729	Catalog 200
E-11412	Catalog 100	E-11528	Catalog 100	E-11592	Catalog 100	E-11730	Catalog 200
E-11413	Catalog 100	E-11529	Catalog 100	E-11593	Catalog 100	E-11731	Catalog 200
E-11414	Catalog 100	E-11530	Catalog 100	E-11594	Catalog 100	E-11732	Catalog 200
E-11415	Catalog 100	E-11531	Catalog 100	E-11595	Catalog 100	E-11739	Catalog 200
E-11416	Catalog 100	E-11532	Catalog 100	E-11596	Catalog 100	E-11740	Catalog 200
E-11417	Catalog 100	E-11533	Catalog 100	E-11597	Catalog 100	E-11741	Catalog 100
E-11418	Catalog 100	E-11534	Catalog 100	E-11598	Catalog 100	E-11742	Catalog 100
E-11419	Catalog 100	E-11535	Catalog 100	E-11599	Catalog 100	E-11743	Catalog 100
E-11420	Catalog 100	E-11536	Catalog 100	E-11600	Catalog 100	E-11744	Catalog 100
E-11421	Catalog 100	E-11537	Catalog 100	E-11601	Catalog 100	E-11745	Catalog 100
E-11422	Catalog 100	E-11538	Catalog 100	E-11602	Catalog 100	E-11746	Catalog 100
E-11423	Catalog 100	E-11539	Catalog 100	E-11603	Catalog 100	E-11785B	11-5,11-4, 11-20,11-142, 11-145,11-146, 11-162,11-163
E-11424	Catalog 100	E-11540	Catalog 100	E-11604	Catalog 100		
E-11425	Catalog 100	E-11541	Catalog 100	E-11605	Catalog 100		
E-11426	Catalog 100	E-11542	Catalog 100	E-11608	Catalog 100		
E-11427	Catalog 100	E-11543	Catalog 100	E-11609	Catalog 100	E-11788	11-9,11-25, 11-37,11-41,
		E-11544	Catalog 100	E-11610	Catalog 100		

MASTER PART NUMBER INDEX

Part No	Page	Part No	Page	Part No	Page	Part No	Page
E-11788 (cont)	11-43,11-55	E78-4505A	Catalog 100	E-801326	Catalog 800	E-802529	Catalog 800
E-11789	11-9,11-25, 11-37,11-41, 11-43,11-55	E78-4514G	Catalog 100	E-801329	Catalog 800	E-802530	Catalog 800
E-11790	11-13,11-25, 11-56	E78-4515	Catalog 100	E-801333	Catalog 800	E-802532	Catalog 800
E-11791	11-6	E78-4515E	Catalog 100	E-801334	Catalog 800	E-802533	Catalog 800
E-11808C	11-2,11-138	E78-4515C	Catalog 100	E-801482	Catalog 800	E-802535	Catalog 800
E-11809C	11-3,11-138	E78-4524B	Catalog 100	E-801484	Catalog 800	E-802536	Catalog 800
E-11810C	11-3,11-138	E78-4527B	Catalog 100	E-801485	Catalog 800	E-802537	Catalog 800
E-11811C	11-3,11-138	E78-4544	Catalog 100	E-801505	Catalog 800	E-802538	Catalog 800
E-11812C	11-2,11-138	E78-4551	Catalog 100	E-801509	Catalog 800	E-802539	Catalog 800
E-11813C	11-4,11-138	E78-4551E	Catalog 100	E-801510	Catalog 800	E-802542	Catalog 800
E-11814C	11-4,11-138	E78-4551B	Catalog 100	E-801511	Catalog 800	E-802543	Catalog 800
E-11815C	11-1,11-138	E78-4591	Catalog 100	E-801512	Catalog 800	E-802547	Catalog 800
E-11816C	11-2,11-138	E78-4605	Catalog 100	E-801551	Catalog 800	E-802548	Catalog 800
E-09SD300R	Catalog 100	E78-4607	Catalog 100	E-801608RM	Catalog 800	E-802558	Catalog 800
E-153100	Catalog 100	E78-4670	Catalog 100	E-801708RM	Catalog 800	E-802561	Catalog 800
E-153101	Catalog 100	E78-4692	Catalog 100	E-801719RM	Catalog 800	E-802562	Catalog 800
E-153102	Catalog 100	E78-4701	Catalog 100	E-801722RM	Catalog 800	E-802563	Catalog 800
E-153103	Catalog 100	E78-4702	Catalog 100	E-801740RM	Catalog 800	E-802564	Catalog 800
E-153104	Catalog 100	E78-4707	Catalog 100	E-801901	Catalog 800	E-802567	Catalog 800
E-153105	Catalog 100	E78-4708	Catalog 100	E-801902	Catalog 800	E-802573	Catalog 800
E-153106	Catalog 100	E78-4709	Catalog 100	E-801903	Catalog 800	E-802574	Catalog 800
E-153107	Catalog 100	E-801102	Catalog 800	E-801904	Catalog 800	E-802579	Catalog 800
E-153108	Catalog 100	E-801125	Catalog 800	E-801905	Catalog 800	E-802580	Catalog 800
E-153109	Catalog 100	E-801129	Catalog 800	E-801906	Catalog 800	E-802581	Catalog 800
E-153110	Catalog 100	E-801130	Catalog 800	E-801907	Catalog 800	E-802592	Catalog 800
E-153111	Catalog 100	E-801131	Catalog 800	E-801908	Catalog 800	E-802593	Catalog 800
E-153112	Catalog 100	E-801161	Catalog 800	E-801910	Catalog 800	E-802594	Catalog 800
E-153113	Catalog 100	E-801163	Catalog 800	E-801912	Catalog 800	E-802595	Catalog 800
E-153114	Catalog 100	E-801165	Catalog 800	E-802145	Catalog 800	E-802596	Catalog 800
E-153115	Catalog 100	E-801166	Catalog 800	E-802146	Catalog 800	E-802597	Catalog 800
E-153116	Catalog 100	E-801167	Catalog 800	E-802147	Catalog 800	E-802598	Catalog 800
E-153150	Catalog 100	E-801169	Catalog 800	E-802148	Catalog 800	E-802684	Catalog 800
E-153200	Catalog 100	E-801170	Catalog 800	E-802159	Catalog 800	E-802686	Catalog 800
E-5480-78	Catalog 100	E-801171	Catalog 800	E-802160	Catalog 800	E-802688	Catalog 800
E-5480-88	Catalog 100	E-801172	Catalog 800	E-802163	Catalog 800	E-802690	Catalog 800
E-5503-78	Catalog 100	E-801173	Catalog 800	E-802164	Catalog 800	E-803000	Catalog 800
E-5503-88	Catalog 100	E-801174	Catalog 800	E-802249	Catalog 800	E-803002	Catalog 800
E55-4311J	Catalog 100	E-801175	Catalog 800	E-802250	Catalog 800	E-803006	Catalog 800
E55-4515	Catalog 100	E-801176	Catalog 800	E-802251	Catalog 800	E-803008	Catalog 800
E55-4515E	Catalog 100	E-801177	Catalog 800	E-802252	Catalog 800	E-803009	Catalog 800
E55-4515C	Catalog 100	E-801178	Catalog 800	E-802253	Catalog 800	E-803010	Catalog 800
E77-4311G	Catalog 100	E-801179	Catalog 800	E-802254	Catalog 800	E-803011	Catalog 800
E77-4311J	Catalog 100	E-801180	Catalog 800	E-802255	Catalog 800	E-803012	Catalog 800
E77-4515	Catalog 100	E-801181	Catalog 800	E-802256	Catalog 800	E-803013	Catalog 800
E77-4515E	Catalog 100	E-801182	Catalog 800	E-802257	Catalog 800	E-803014	Catalog 800
E77-4515C	Catalog 100	E-801183	Catalog 800	E-802257	Catalog 800	E-803015	Catalog 800
E77-4524B	Catalog 100	E-801184	Catalog 800	E-802500	Catalog 800	E-803016	Catalog 800
E77-4551B	Catalog 100	E-801185	Catalog 800	E-802501	Catalog 800	E-803017	Catalog 800
E77-4591	Catalog 100	E-801186	Catalog 800	E-802502	Catalog 800	E-803018	Catalog 800
E77-4605	Catalog 100	E-801187	Catalog 800	E-802504	Catalog 800	E-803020	Catalog 800
E77-4670	Catalog 100	E-801188	Catalog 800	E-802506	Catalog 800	E-803021	Catalog 800
E77-4702	Catalog 100	E-801189	Catalog 800	E-802508	Catalog 800	E-803022	Catalog 800
E77-4707	Catalog 100	E-801190	Catalog 800	E-802511	Catalog 800	E-803023	Catalog 800
E77-4709	Catalog 100	E-801191	Catalog 800	E-802513	Catalog 800	E-803024	Catalog 800
E77-4715	Catalog 100	E-801192	Catalog 800	E-802514	Catalog 800	E-803025	Catalog 800
E78-1308	Catalog 100	E-801193	Catalog 800	E-802515	Catalog 800	E-803026	Catalog 800
E78-1443TT	Catalog 100	E-801199	Catalog 800	E-802516	Catalog 800	E-803027	Catalog 800
E78-4311B	Catalog 100	E-801314	Catalog 800	E-802517	Catalog 800	E-803028	Catalog 800
E78-4311J	Catalog 100	E-801319	Catalog 800	E-802519	Catalog 800	E-803028	Catalog 800
E78-4471B	Catalog 100	E-801321	Catalog 800	E-802520	Catalog 800	E-803029	Catalog 800
E78-4504A	Catalog 100	E-801322	Catalog 800	E-802522	Catalog 800	E-803030	Catalog 800
		E-801323	Catalog 800	E-802523	Catalog 800	E-803031	Catalog 800
		E-801324	Catalog 800	E-802524	Catalog 800	E-803032	Catalog 800
		E-801325	Catalog 800	E-802525	Catalog 800	E-803033	Catalog 800
				E-802528	Catalog 800	E-803034	Catalog 800

MASTER PART NUMBER INDEX

Part No	Page	Part No	Page	Part No	Page	Part No	Page
E-806073	Catalog 800	E-807253	Catalog 800	E-807985	Catalog 800	E-808035-8	Catalog 800
E-807000	Catalog 800	E-807254	Catalog 800	E-807986	Catalog 800	E-808036-10	Catalog 800
E-807001	Catalog 800	E-807300	Catalog 800	E-807987	Catalog 800	E-808036-8	Catalog 800
E-807002	Catalog 800	E-807301	Catalog 800	E-807988	Catalog 800	E-808037-10	Catalog 800
E-807003	Catalog 800	E-807303	Catalog 800	E-807989	Catalog 800	E-808037-8	Catalog 800
E-807004	Catalog 800	E-807307	Catalog 800	E-807993	Catalog 800	E-808038-10	Catalog 800
E-807005	Catalog 800	E-807321	Catalog 800	E-807996	Catalog 800	E-808038-12	Catalog 800
E-807006	Catalog 800	E-807322	Catalog 800	E-807998	Catalog 800	E-808038-8	Catalog 800
E-807008	Catalog 800	E-807323	Catalog 800	E-808007-10	Catalog 800	E-808039-10	Catalog 800
E-807011	Catalog 800	E-807325	Catalog 800	E-808007-6	Catalog 800	E-808039-8	Catalog 800
E-807012	Catalog 800	E-807330	Catalog 800	E-808007-8	Catalog 800	E-808040-10	Catalog 800
E-807013	Catalog 800	E-807332	Catalog 800	E-808008-10	Catalog 800	E-808040-8	Catalog 800
E-807016	Catalog 800	E-807333	Catalog 800	E-808008-6	Catalog 800	E-808041-10	Catalog 800
E-807017	Catalog 800	E-807334	Catalog 800	E-808009-10	Catalog 800	E-808041-8	Catalog 800
E-807018	Catalog 800	E-807335	Catalog 800	E-808009-6	Catalog 800	E-808100-10	Catalog 800
E-807019	Catalog 800	E-807336	Catalog 800	E-808009-8	Catalog 800	E-808100-12	Catalog 800
E-807020	Catalog 800	E-807338	Catalog 800	E-808010	Catalog 800	E-808100-6	Catalog 800
E-807021	Catalog 800	E-807339	Catalog 800	E-808011	Catalog 800	E-808100-8	Catalog 800
E-807022	Catalog 800	E-807340	Catalog 800	E-808012	Catalog 800	E-808101-10	Catalog 800
E-807028	Catalog 800	E-807345	Catalog 800	E-808013	Catalog 800	E-808101-12	Catalog 800
E-807030	Catalog 800	E-807346	Catalog 800	E-808014-10	Catalog 800	E-808101-6	Catalog 800
E-807031	Catalog 800	E-807347	Catalog 800	E-808014-8	Catalog 800	E-808101-8	Catalog 800
E-807034	Catalog 800	E-807348	Catalog 800	E-808015-10	Catalog 800	E-808102-10	Catalog 800
E-807035	Catalog 800	E-807349	Catalog 800	E-808015-12	Catalog 800	E-808102-12	Catalog 800
E-807038	Catalog 800	E-807350	Catalog 800	E-808015-8	Catalog 800	E-808102-6	Catalog 800
E-807049	Catalog 800	E-807351	Catalog 800	E-808016-10	Catalog 800	E-808102-8	Catalog 800
E-807100	Catalog 800	E-807354	Catalog 800	E-808016-8	Catalog 800	E-808110-10	Catalog 800
E-807101	Catalog 800	E-807355	Catalog 800	E-808017-10	Catalog 800	E-808110-12	Catalog 800
E-807102	Catalog 800	E-807356	Catalog 800	E-808017-8	Catalog 800	E-808110-6	Catalog 800
E-807103	Catalog 800	E-807357	Catalog 800	E-808018-10	Catalog 800	E-808110-8	Catalog 800
E-807104	Catalog 800	E-807358	Catalog 800	E-808018-8	Catalog 800	E-808111-10	Catalog 800
E-807105	Catalog 800	E-807366	Catalog 800	E-808019-10	Catalog 800	E-808111-12	Catalog 800
E-807106	Catalog 800	E-807373	Catalog 800	E-808019-8	Catalog 800	E-808111-6	Catalog 800
E-807107	Catalog 800	E-807500	Catalog 800	E-808020-10	Catalog 800	E-808111-8	Catalog 800
E-807108	Catalog 800	E-807501	Catalog 800	E-808020-8	Catalog 800	E-808112-10	Catalog 800
E-807109	Catalog 800	E-807502	Catalog 800	E-808021-10	Catalog 800	E-808112-12	Catalog 800
E-807110	Catalog 800	E-807503	Catalog 800	E-808021-8	Catalog 800	E-808112-6	Catalog 800
E-807111	Catalog 800	E-807506	Catalog 800	E-808022-10	Catalog 800	E-808112-8	Catalog 800
E-807112	Catalog 800	E-807515	Catalog 800	E-808022-12	Catalog 800	E-808113-10	Catalog 800
E-807113	Catalog 800	E-807517	Catalog 800	E-808022-8	Catalog 800	E-808113-6	Catalog 800
E-807114	Catalog 800	E-807520	Catalog 800	E-808023-10	Catalog 800	E-808115-6	Catalog 800
E-807115	Catalog 800	E-807521	Catalog 800	E-808023-12	Catalog 800	E-808115-8	Catalog 800
E-807116	Catalog 800	E-807525	Catalog 800	E-808023-8	Catalog 800	E-808120-10	Catalog 800
E-807117	Catalog 800	E-807528	Catalog 800	E-808024-10	Catalog 800	E-808120-12	Catalog 800
E-807120	Catalog 800	E-807529	Catalog 800	E-808024-8	Catalog 800	E-808120-6	Catalog 800
E-807121	Catalog 800	E-807530	Catalog 800	E-808025-10	Catalog 800	E-808120-8	Catalog 800
E-807122	Catalog 800	E-807531	Catalog 800	E-808025-8	Catalog 800	E-808121-10	Catalog 800
E-807123	Catalog 800	E-807532	Catalog 800	E-808026-10	Catalog 800	E-808121-12	Catalog 800
E-807124	Catalog 800	E-807533	Catalog 800	E-808026-8	Catalog 800	E-808121-6	Catalog 800
E-807125	Catalog 800	E-807534	Catalog 800	E-808027-10	Catalog 800	E-808121-8	Catalog 800
E-807126	Catalog 800	E-807600	Catalog 800	E-808027-8	Catalog 800	E-808122-10	Catalog 800
E-807127	Catalog 800	E-807601	Catalog 800	E-808028-10	Catalog 800	E-808122-12	Catalog 800
E-807131	Catalog 800	E-807602	Catalog 800	E-808028-8	Catalog 800	E-808122-6	Catalog 800
E-807133	Catalog 800	E-807603	Catalog 800	E-808029-10	Catalog 800	E-808122-8	Catalog 800
E-807135	Catalog 800	E-807605	Catalog 800	E-808029-8	Catalog 800	E-808130-10	Catalog 800
E-807137	Catalog 800	E-807606	Catalog 800	E-808030-10	Catalog 800	E-808130-12	Catalog 800
E-807150	Catalog 800	E-807607	Catalog 800	E-808030-8	Catalog 800	E-808130-6	Catalog 800
E-807200	Catalog 800	E-807608	Catalog 800	E-808031-10	Catalog 800	E-808130-8	Catalog 800
E-807200M-10	Catalog 800	E-807609	Catalog 800	E-808031-8	Catalog 800	E-808131-10	Catalog 800
E-807201	Catalog 800	E-807610	Catalog 800	E-808032-10	Catalog 800	E-808131-12	Catalog 800
E-807202	Catalog 800	E-807980	Catalog 800	E-808032-8	Catalog 800	E-808131-6	Catalog 800
E-807250	Catalog 800	E-807981	Catalog 800	E-808034-10	Catalog 800	E-808131-8	Catalog 800
E-807251	Catalog 800	E-807982	Catalog 800	E-808034-8	Catalog 800	E-808132-10	Catalog 800
E-807252	Catalog 800	E-807984	Catalog 800	E-808035-10	Catalog 800	E-808132-12	Catalog 800

MASTER PART NUMBER INDEX

Part No	Page	Part No	Page	Part No	Page	Part No	Page
E-808132-6	Catalog 800	E-808222R-6	Catalog 800	E-808400-8-6	Catalog 800	E-808418-10	Catalog 800
E-808132-8	Catalog 800	E-808222R-8	Catalog 800	E-808401-10-12	Catalog 800	E-808418-6	Catalog 800
E-808133-10	Catalog 800	E-808230-10	Catalog 800	E-808401-6-8	Catalog 800	E-808418-8	Catalog 800
E-808133-6	Catalog 800	E-808230-12	Catalog 800	E-808401-8-10	Catalog 800	E-808419-10-12	Catalog 800
E-808133-8	Catalog 800	E-808230-6	Catalog 800	E-808402-10-12	Catalog 800	E-808419-6	Catalog 800
E-808135-10	Catalog 800	E-808230-8	Catalog 800	E-808402-10-8	Catalog 800	E-808419-8-10	Catalog 800
E-808135-6	Catalog 800	E-808231-10	Catalog 800	E-808402-12-10	Catalog 800	E-808420-10	Catalog 800
E-808135-8	Catalog 800	E-808231-12	Catalog 800	E-808402-6-8	Catalog 800	E-808420-6	Catalog 800
E-808136-10	Catalog 800	E-808231-6	Catalog 800	E-808402-8-10	Catalog 800	E-808420-8	Catalog 800
E-808136-6	Catalog 800	E-808231-8	Catalog 800	E-808402-8-6	Catalog 800	E-808421-10-12	Catalog 800
E-808136-8	Catalog 800	E-808231R-10	Catalog 800	E-808403-10-12	Catalog 800	E-808421-6-8	Catalog 800
E-808137-10	Catalog 800	E-808231R-12	Catalog 800	E-808404-10-12	Catalog 800	E-808421-8-10	Catalog 800
E-808137-6	Catalog 800	E-808231R-6	Catalog 800	E-808404-10-8	Catalog 800	E-808423-10	Catalog 800
E-808137-8	Catalog 800	E-808231R-8	Catalog 800	E-808404-12-10	Catalog 800	E-808423-6	Catalog 800
E-808138-10	Catalog 800	E-808232-10	Catalog 800	E-808404-6	Catalog 800	E-808423-8	Catalog 800
E-808138-6	Catalog 800	E-808232-12	Catalog 800	E-808404-8-10	Catalog 800	E-808424-10	Catalog 800
E-808138-8	Catalog 800	E-808232-6	Catalog 800	E-808404-8-6	Catalog 800	E-808424-6	Catalog 800
E-808139-6	Catalog 800	E-808232-8	Catalog 800	E-808405-6-8	Catalog 800	E-808424-6-8	Catalog 800
E-808140-10	Catalog 800	E-808232R-10	Catalog 800	E-808405-8-10	Catalog 800	E-808424-8	Catalog 800
E-808140-12	Catalog 800	E-808232R-12	Catalog 800	E-808405-8-6	Catalog 800	E-808424-8-10	Catalog 800
E-808140-6	Catalog 800	E-808232R-6	Catalog 800	E-808406-10-12	Catalog 800	E-808425-10	Catalog 800
E-808140-8	Catalog 800	E-808232R-8	Catalog 800	E-808406-10-8	Catalog 800	E-808425-6	Catalog 800
E-808200-10	Catalog 800	E-808233-10	Catalog 800	E-808406-6-8	Catalog 800	E-808425-6-8	Catalog 800
E-808200-12	Catalog 800	E-808233-6	Catalog 800	E-808406-8-10	Catalog 800	E-808425-8	Catalog 800
E-808200-6	Catalog 800	E-808233-8	Catalog 800	E-808406-8-6	Catalog 800	E-808425-8-10	Catalog 800
E-808200-8	Catalog 800	E-808234-10	Catalog 800	E-808407-10-12	Catalog 800	E-808428-10	Catalog 800
E-808201-10	Catalog 800	E-808234-6	Catalog 800	E-808407-10-8	Catalog 800	E-808428-8	Catalog 800
E-808201-12	Catalog 800	E-808234-8	Catalog 800	E-808407-6-8	Catalog 800	E-808429-10	Catalog 800
E-808201-6	Catalog 800	E-808235-10	Catalog 800	E-808407-8-10	Catalog 800	E-808429-8	Catalog 800
E-808201-8	Catalog 800	E-808235-10-12	Catalog 800	E-808408-10-12	Catalog 800	E-808432	Catalog 800
E-808202-10	Catalog 800	E-808235-6	Catalog 800	E-808408-10-8	Catalog 800	E-808435-10	Catalog 800
E-808202-12	Catalog 800	E-808235-8	Catalog 800	E-808408-6-8	Catalog 800	E-808435-10-1	Catalog 800
E-808202-6	Catalog 800	E-808236-10	Catalog 800	E-808408-8-10	Catalog 800	E-808435-12	Catalog 800
E-808202-8	Catalog 800	E-808236-10-12	Catalog 800	E-808408-8-6	Catalog 800	E-808435-12-1	Catalog 800
E-808210-10	Catalog 800	E-808236-6	Catalog 800	E-808410-10-12	Catalog 800	E-808435-6	Catalog 800
E-808210-12	Catalog 800	E-808236-8	Catalog 800	E-808410-10-8	Catalog 800	E-808435-8	Catalog 800
E-808210-6	Catalog 800	E-808236R-10	Catalog 800	E-808410-6-8	Catalog 800	E-808437	Catalog 800
E-808210-8	Catalog 800	E-808236R-10-12	Catalog 800	E-808410-8-10	Catalog 800	E-808437-10	Catalog 800
E-808211-10	Catalog 800	E-808236R-6	Catalog 800	E-808410-8-6	Catalog 800	E-808437-6	Catalog 800
E-808211-12	Catalog 800	E-808236R-8	Catalog 800	E-808411-10-12	Catalog 800	E-808437-8	Catalog 800
E-808211-6	Catalog 800	E-808237-10	Catalog 800	E-808411-6-8	Catalog 800	E-808440-10	Catalog 800
E-808211-8	Catalog 800	E-808237-6	Catalog 800	E-808411-8-10	Catalog 800	E-808440-12	Catalog 800
E-808212-10	Catalog 800	E-808237-8	Catalog 800	E-808411-8-6	Catalog 800	E-808440-6	Catalog 800
E-808212-12	Catalog 800	E-808238-10	Catalog 800	E-808412-10-10	Catalog 800	E-808440-8	Catalog 800
E-808212-6	Catalog 800	E-808238-6	Catalog 800	E-808412-12-12	Catalog 800	E-808441-10	Catalog 800
E-808212-8	Catalog 800	E-808238-8	Catalog 800	E-808412-6-6	Catalog 800	E-808441-6	Catalog 800
E-808220-10	Catalog 800	E-808238R-10	Catalog 800	E-808412-8-8	Catalog 800	E-808441-8	Catalog 800
E-808220-12	Catalog 800	E-808238R-6	Catalog 800	E-808413-10-12	Catalog 800	E-808443	Catalog 800
E-808220-6	Catalog 800	E-808238R-8	Catalog 800	E-808413-6-8	Catalog 800	E-808444-10	Catalog 800
E-808220-8	Catalog 800	E-808239-6	Catalog 800	E-808413-8-10	Catalog 800	E-808444-12	Catalog 800
E-808220R-10	Catalog 800	E-808239-8	Catalog 800	E-808414-10	Catalog 800	E-808444-6	Catalog 800
E-808220R-10-12	Catalog 800	E-808240-10	Catalog 800	E-808414-12	Catalog 800	E-808444-8	Catalog 800
E-808220R-6	Catalog 800	E-808240-12	Catalog 800	E-808414-12-10	Catalog 800	E-808445-10	Catalog 800
E-808220R-8	Catalog 800	E-808240-6	Catalog 800	E-808414-6	Catalog 800	E-808445-8	Catalog 800
E-808221-10	Catalog 800	E-808240-8	Catalog 800	E-808414-8	Catalog 800	E-808446-10	Catalog 800
E-808221-12	Catalog 800	E-808241-10	Catalog 800	E-808415-10	Catalog 800	E-808446-8	Catalog 800
E-808221-6	Catalog 800	E-808241-8	Catalog 800	E-808415-12	Catalog 800	E-808450-10-12	Catalog 800
E-808221-8	Catalog 800	E-808242-10	Catalog 800	E-808415-6	Catalog 800	E-808450-12	Catalog 800
E-808222-10	Catalog 800	E-808242-8	Catalog 800	E-808415-8	Catalog 800	E-808450-6	Catalog 800
E-808222-12	Catalog 800	E-808400-10-12	Catalog 800	E-808416-10	Catalog 800	E-808450-8	Catalog 800
E-808222-6	Catalog 800	E-808400-10-8	Catalog 800	E-808416-12	Catalog 800	E-808451-10-12	Catalog 800
E-808222-8	Catalog 800	E-808400-12-10	Catalog 800	E-808417-10	Catalog 800	E-808451-12	Catalog 800
E-808222R-10	Catalog 800	E-808400-6-8	Catalog 800	E-808417-6	Catalog 800	E-808451-6	Catalog 800
E-808222R-10-12	Catalog 800	E-808400-8-10	Catalog 800	E-808417-8	Catalog 800	E-808451-8	Catalog 800

MASTER PART NUMBER INDEX

Part No	Page	Part No	Page	Part No	Page	Part No	Page
E-808452-12	Catalog 800	E-808539-6	Catalog 800	E-808557-20-6	Catalog 800	E-808645R-6-8	Catalog 800
E-808452-6	Catalog 800	E-808539-8	Catalog 800	E-808557-20-8	Catalog 800	E-808645R-8-10	Catalog 800
E-808452-8	Catalog 800	E-808540-10	Catalog 800	E-808557-22-10	Catalog 800	E-808650-12-10	Catalog 800
E-808453-10-12	Catalog 800	E-808540-12	Catalog 800	E-808557-24-10	Catalog 800	E-808651-12-10	Catalog 800
E-808453-6-8	Catalog 800	E-808540-6	Catalog 800	E-808557-27-12	Catalog 800	E-808810-10	Catalog 800
E-808453-8-10	Catalog 800	E-808540-8	Catalog 800	E-808610-10-12	Catalog 800	E-808810-12	Catalog 800
E-808454-6	Catalog 800	E-808541-10	Catalog 800	E-808610-6-8	Catalog 800	E-808810-6	Catalog 800
E-808454-8	Catalog 800	E-808541-12	Catalog 800	E-808610-8-10	Catalog 800	E-808810-8	Catalog 800
E-808490-10	Catalog 800	E-808541-6	Catalog 800	E-808610-8-6	Catalog 800	E-808812-10	Catalog 800
E-808490-6	Catalog 800	E-808541-8	Catalog 800	E-808611-10-12	Catalog 800	E-808812-10-12	Catalog 800
E-808490-8	Catalog 800	E-808542-10	Catalog 800	E-808611-6-8	Catalog 800	E-808812-6	Catalog 800
E-808491-10	Catalog 800	E-808542-12	Catalog 800	E-808611-8-10	Catalog 800	E-808812-8	Catalog 800
E-808491-6	Catalog 800	E-808542-6	Catalog 800	E-808611-8-6	Catalog 800	E-808820-10	Catalog 800
E-808491-8	Catalog 800	E-808542-8	Catalog 800	E-808612-10-12	Catalog 800	E-808820-12	Catalog 800
E-808492-10	Catalog 800	E-808543-10	Catalog 800	E-808612-6-8	Catalog 800	E-808820-6	Catalog 800
E-808492-6	Catalog 800	E-808543-12	Catalog 800	E-808612-8-10	Catalog 800	E-808820-8	Catalog 800
E-808492-8	Catalog 800	E-808543-6	Catalog 800	E-808612-8-6	Catalog 800	E-808820R-10	Catalog 800
E-808493	Catalog 800	E-808543-8	Catalog 800	E-808620-10-12	Catalog 800	E-808820R-10-12	Catalog 800
E-808493-10	Catalog 800	E-808544-10	Catalog 800	E-808620-6-8	Catalog 800	E-808820R-6	Catalog 800
E-808493-6	Catalog 800	E-808544-12	Catalog 800	E-808620-8-6	Catalog 800	E-808820R-8	Catalog 800
E-808493-8	Catalog 800	E-808544-6	Catalog 800	E-808621-6-8	Catalog 800	E-808821-10	Catalog 800
E-808494	Catalog 800	E-808544-8	Catalog 800	E-808621-8-6	Catalog 800	E-808821-12	Catalog 800
E-808495	Catalog 800	E-808545-10	Catalog 800	E-808622-10-12	Catalog 800	E-808821-6	Catalog 800
E-808498	Catalog 800	E-808545-12	Catalog 800	E-808622-6-8	Catalog 800	E-808821-8	Catalog 800
E-808499	Catalog 800	E-808545-6	Catalog 800	E-808622-8-6	Catalog 800	E-808822-10	Catalog 800
E-808517-10	Catalog 800	E-808545-8	Catalog 800	E-808630-10-12	Catalog 800	E-808822-12	Catalog 800
E-808517-6	Catalog 800	E-808545R-10	Catalog 800	E-808630-12-10	Catalog 800	E-808822-6	Catalog 800
E-808517-8	Catalog 800	E-808545R-12	Catalog 800	E-808630-6-8	Catalog 800	E-808822-8	Catalog 800
E-808518-10	Catalog 800	E-808545R-6	Catalog 800	E-808630-8-10	Catalog 800	E-808822R-10	Catalog 800
E-808518-6	Catalog 800	E-808545R-8	Catalog 800	E-808630-8-6	Catalog 800	E-808822R-10-12	Catalog 800
E-808518-8	Catalog 800	E-808546-10	Catalog 800	E-808631-10-12	Catalog 800	E-808822R-6	Catalog 800
E-808519-10	Catalog 800	E-808546-12	Catalog 800	E-808631-6-8	Catalog 800	E-808822R-8	Catalog 800
E-808519-6	Catalog 800	E-808546-6	Catalog 800	E-808631-8-10	Catalog 800	E-808830-10	Catalog 800
E-808519-8	Catalog 800	E-808546-8	Catalog 800	E-808631R-10-12	Catalog 800	E-808830-10-12	Catalog 800
E-808520-10	Catalog 800	E-808546-8	Catalog 800	E-808632-10-12	Catalog 800	E-808830-6	Catalog 800
E-808520-6	Catalog 800	E-808547-8	Catalog 800	E-808632-12-10	Catalog 800	E-808830-8	Catalog 800
E-808520-8	Catalog 800	E-808548-10	Catalog 800	E-808632-12-10	Catalog 800	E-808830R-10	Catalog 800
E-808523-10	Catalog 800	E-808548-12	Catalog 800	E-808632-6-8	Catalog 800	E-808830R-10-12	Catalog 800
E-808523-6	Catalog 800	E-808548-6	Catalog 800	E-808632-8-10	Catalog 800	E-808830R-12	Catalog 800
E-808523-8	Catalog 800	E-808548-8	Catalog 800	E-808632-8-6	Catalog 800	E-808830R-6	Catalog 800
E-808524-10	Catalog 800	E-808548R-10	Catalog 800	E-808632R-10-12	Catalog 800	E-808830R-8	Catalog 800
E-808524-6	Catalog 800	E-808548R-12	Catalog 800	E-808632R-8-6	Catalog 800	E-808831-10	Catalog 800
E-808524-8	Catalog 800	E-808548R-6	Catalog 800	E-808633-10-12	Catalog 800	E-808831-12	Catalog 800
E-808528-7	Catalog 800	E-808548R-8	Catalog 800	E-808634-10-12	Catalog 800	E-808831-6-6	Catalog 800
E-808529-7	Catalog 800	E-808549-10	Catalog 800	E-808634-8-6	Catalog 800	E-808831-8	Catalog 800
E-808535-10	Catalog 800	E-808549-12	Catalog 800	E-808635-10-12	Catalog 800	E-808831R-10	Catalog 800
E-808535-12	Catalog 800	E-808549-6	Catalog 800	E-808637-10-12	Catalog 800	E-808831R-10-12	Catalog 800
E-808535-6	Catalog 800	E-808549-8	Catalog 800	E-808638-10-12	Catalog 800	E-808831R-12	Catalog 800
E-808535-8	Catalog 800	E-808550-10	Catalog 800	E-808638R-10-12	Catalog 800	E-808831R-6	Catalog 800
E-808535R-10	Catalog 800	E-808550-12	Catalog 800	E-808639-10-12	Catalog 800	E-808831R-8	Catalog 800
E-808535R-6	Catalog 800	E-808550-6	Catalog 800	E-808639-8-6	Catalog 800	E-808832-10-10	Catalog 800
E-808535R-8	Catalog 800	E-808550-8	Catalog 800	E-808640-10-12	Catalog 800	E-808832-10-12	Catalog 800
E-808536-10	Catalog 800	E-808551-10	Catalog 800	E-808640-8-6	Catalog 800	E-808832-6-6	Catalog 800
E-808536-12	Catalog 800	E-808551-6	Catalog 800	E-808641-12	Catalog 800	E-808832-8-8	Catalog 800
E-808536R-10-12	Catalog 800	E-808551-8	Catalog 800	E-808641-8-6	Catalog 800	E-808832R-10	Catalog 800
E-808536R-8-10	Catalog 800	E-808552-22	Catalog 800	E-808642-10-12	Catalog 800	E-808832R-10-12	Catalog 800
E-808537-10	Catalog 800	E-808553-20	Catalog 800	E-808642-8-6	Catalog 800	E-808832R-12	Catalog 800
E-808537-6	Catalog 800	E-808553-27	Catalog 800	E-808643-10-12	Catalog 800	E-808832R-6	Catalog 800
E-808537-8	Catalog 800	E-808554-10-10	Catalog 800	E-808643-8-6	Catalog 800	E-808832R-8	Catalog 800
E-808538-10	Catalog 800	E-808554-12-10	Catalog 800	E-808644-10-12	Catalog 800	E-808836R-10	Catalog 800
E-808538-6	Catalog 800	E-808554-8-6	Catalog 800	E-808644-8-6	Catalog 800	E-808836R-10-12	Catalog 800
E-808538-8	Catalog 800	E-808555-10	Catalog 800	E-808645-10-10	Catalog 800	E-808836R-6	Catalog 800
E-808539-10	Catalog 800	E-808555-12	Catalog 800	E-808645-6-8	Catalog 800	E-808836R-8	Catalog 800
E-808539-12	Catalog 800	E-808556-10	Catalog 800	E-808645-8-10	Catalog 800	E-808838-10	Catalog 800
		E-808556-6	Catalog 800	E-808645R-10-12	Catalog 800		

MASTER PART NUMBER INDEX

Part No	Page	Part No	Page	Part No	Page	Part No	Page
E-813082	Catalog 100	E-819140	Catalog 800	E-820203	Catalog 820	E-821171X	Catalog 820
E-813083	Catalog 100	E-819142	Catalog 800	E-820203X	Catalog 820	E-821172X	Catalog 820
E-813084	Catalog 100	E-819158	Catalog 800	E-820206X	Catalog 820	E-821173X	Catalog 820
E-813085	Catalog 100	E-819159	Catalog 800	E-820208X	Catalog 820	E-821174X	Catalog 820
E-813086	Catalog 100	E-819175	Catalog 800	E-820209X	Catalog 820	E-821175X	Catalog 820
E-813087	Catalog 100	E-819177	Catalog 800	E-820300X	Catalog 820	E-822100	Catalog 820
E-813090	Catalog 100	E-819203	Catalog 800	E-820301	Catalog 820	E-822101	Catalog 820
E-813091	Catalog 100	E-819207	Catalog 800	E-820301X	Catalog 820	E-822102	Catalog 820
E-813092	Catalog 100	E-819209	Catalog 800	E-820302X	Catalog 820	E-822103	Catalog 820
E-814024	Catalog 800	E-819214	Catalog 800	E-820304X	Catalog 820	E-822104	Catalog 820
E-814025	Catalog 800	E-819216	Catalog 800	E-820305X	Catalog 820	E-822105	Catalog 820
E-814029	Catalog 800	E-819219	Catalog 800	E-820308X	Catalog 820	E-822106	Catalog 820
E-814033	Catalog 800	E-819221	Catalog 800	E-820309X	Catalog 820	E-822107	Catalog 820
E-814034	Catalog 800	E-819500	Catalog 800	E-820400X	Catalog 820	E-822108	Catalog 820
E-814035	Catalog 800	E-819501	Catalog 800	E-821100X	Catalog 820	E-822111	Catalog 820
E-814036	Catalog 800	E-819502	Catalog 800	E-821101X	Catalog 820	E-822112	Catalog 820
E-814037	Catalog 800	E-819503	Catalog 800	E-821103X	Catalog 820	E-822113	Catalog 820
E-814038	Catalog 800	E-819504	Catalog 800	E-821104X	Catalog 820	E-822114	Catalog 820
E-814041	Catalog 800	E-819505	Catalog 800	E-821106X	Catalog 820	E-822115	Catalog 820
E-814043	Catalog 100	E-820100X	Catalog 820	E-821108X	Catalog 820	E-822116	Catalog 820
E-814044	Catalog 100	E-820101X	Catalog 820	E-821109X	Catalog 820	E-822117	Catalog 820
E-814048	Catalog 800	E-820102X	Catalog 820	E-821110X	Catalog 820	E-822200	Catalog 820
E-814071	Catalog 800	E-820103X	Catalog 820	E-821112X	Catalog 820	E-822201	Catalog 820
E-814072	Catalog 800	E-820104X	Catalog 820	E-821114X	Catalog 820	E-822202	Catalog 820
E-814100	Catalog 800	E-820105X	Catalog 820	E-821115	Catalog 820	E-822204	Catalog 820
E-814101	Catalog 800	E-820106X	Catalog 820	E-821115X	Catalog 820	E-822205	Catalog 820
E-814102	Catalog 800	E-820107X	Catalog 820	E-821116X	Catalog 820	E-822206	Catalog 820
E-814103	Catalog 800	E-820108X	Catalog 820	E-821117X	Catalog 820	E-822207	Catalog 820
E-814104A	Catalog 800	E-820109	Catalog 820	E-821118X	Catalog 820	E-822208	Catalog 820
E-814121	Catalog 800	E-820109X	Catalog 820	E-821119	Catalog 820	E-822300	Catalog 820
E-814123	Catalog 800	E-820110X	Catalog 820	E-821119X	Catalog 820	E-823101	Catalog 820
E-814124	Catalog 800	E-820111X	Catalog 820	E-821121X	Catalog 820	E-823101X	Catalog 820
E-814131	Catalog 800	E-820115	Catalog 820	E-821122X	Catalog 820	E-823102	Catalog 820
E-814132	Catalog 800	E-820115X	Catalog 820	E-821123X	Catalog 820	E-823102X	Catalog 820
E-814140	Catalog 800	E-820117X	Catalog 820	E-821124	Catalog 820	E-823103	Catalog 820
E-814141	Catalog 800	E-820119X	Catalog 820	E-821124X	Catalog 820	E-823103X	Catalog 820
E-814142	Catalog 800	E-820120X	Catalog 820	E-821125X	Catalog 820	E-823104	Catalog 820
E-814143	Catalog 800	E-820123X	Catalog 820	E-821126X	Catalog 820	E-823104X	Catalog 820
E-814145	Catalog 800	E-820125	Catalog 820	E-821127	Catalog 820	E-823105	Catalog 820
E-814150	Catalog 800	E-820125X	Catalog 820	E-821127X	Catalog 820	E-823105X	Catalog 820
E-814151	Catalog 800	E-820131X	Catalog 820	E-821128X	Catalog 820	E-823106	Catalog 820
E-814152	Catalog 800	E-820132	Catalog 820	E-821129X	Catalog 820	E-823106X	Catalog 820
E-814160	Catalog 800	E-820132X	Catalog 820	E-821131X	Catalog 820	E-823200	Catalog 820
E-814161	Catalog 800	E-820135X	Catalog 820	E-821132	Catalog 820	E-823200X	Catalog 820
E-814162	Catalog 800	E-820136	Catalog 820	E-821132X	Catalog 820	E-823201	Catalog 820
E-814163	Catalog 800	E-820136X	Catalog 820	E-821134X	Catalog 820	E-823201X	Catalog 820
E-814164	Catalog 800	E-820137	Catalog 820	E-821135X	Catalog 820	E-823202	Catalog 820
E-814165	Catalog 800	E-820137X	Catalog 820	E-821137X	Catalog 820	E-823202X	Catalog 820
E-814170	Catalog 800	E-820138	Catalog 820	E-821138X	Catalog 820	E-823203	Catalog 820
E-814171	Catalog 800	E-820138X	Catalog 820	E-821141X	Catalog 820	E-823203X	Catalog 820
E-814901	Catalog 800	E-820139	Catalog 820	E-821142X	Catalog 820	E-823204	Catalog 820
E-819101	Catalog 800	E-820139X	Catalog 820	E-821143X	Catalog 820	E-823204X	Catalog 820
E-819102	Catalog 800	E-820140	Catalog 820	E-821148X	Catalog 820	E-823205	Catalog 820
E-819103	Catalog 800	E-820140X	Catalog 820	E-821149X	Catalog 820	E-823205X	Catalog 820
E-819113	Catalog 800	E-820141	Catalog 820	E-821151X	Catalog 820	E-823206	Catalog 820
E-819115	Catalog 800	E-820141X	Catalog 820	E-821154X	Catalog 820	E-823206X	Catalog 820
E-819118	Catalog 800	E-820142	Catalog 820	E-821157X	Catalog 820	E-823208	Catalog 820
E-819129	Catalog 800	E-820142X	Catalog 820	E-821158X	Catalog 820	E-823208X	Catalog 820
E-819130	Catalog 800	E-820143X	Catalog 820	E-821162X	Catalog 820	E-823209	Catalog 820
E-819131	Catalog 800	E-820144X	Catalog 820	E-821162X	Catalog 820	E-823209X	Catalog 820
E-819133	Catalog 800	E-820145X	Catalog 820	E-821163X	Catalog 820	E-823210X	Catalog 820
E-819134	Catalog 800	E-820200X	Catalog 820	E-821167X	Catalog 820	E-823213	Catalog 820
E-819137	Catalog 800	E-820202	Catalog 820	E-821168X	Catalog 820	E-823213X	Catalog 820
E-819138	Catalog 800	E-820202X	Catalog 820	E-821169X	Catalog 820	E-823214	Catalog 820
				E-821170X	Catalog 820		

MASTER PART NUMBER INDEX

Part No	Page	Part No	Page	Part No	Page	Part No	Page
E-823214X	Catalog 820	E-823900	Catalog 820	E-BC30S	Catalog 100	E-BN103211X	Catalog 100
E-823215	Catalog 820	E-823900X	Catalog 820	E-BC3636C	Catalog 100	E-BN103212X	Catalog 100
E-823215X	Catalog 820	E-823901	Catalog 820	E-BC3636P	Catalog 100	E-BN103274X	Catalog 100
E-823216	Catalog 820	E-823901X	Catalog 820	E-BC36S	Catalog 100	E-BN103278X	Catalog 100
E-823217	Catalog 820	E-823902	Catalog 820	E-BN065041X	Catalog 100	E-BN103294X	Catalog 100
E-823300	Catalog 820	E-823903	Catalog 820	E-BN065044X	Catalog 100	E-BN103833X	Catalog 100
E-823300X	Catalog 820	E-823904X	Catalog 820	E-BN065060X	Catalog 100	E-BN103835X	Catalog 100
E-823301	Catalog 820	E-824100	Catalog 100	E-BN065077X	Catalog 100	E-BN103912X	Catalog 100
E-823301X	Catalog 820	E-824101	Catalog 100	E-BN065104X	Catalog 100	E-BN103976X	Catalog 100
E-823302	Catalog 820	E-824103	Catalog 100	E-BN065125X	Catalog 100	E-BN104039X	Catalog 100
E-823302X	Catalog 820	E-824104	Catalog 100	E-BN065145X	Catalog 100	E-BN104041X	Catalog 100
E-823303	Catalog 820	E-824105	Catalog 100	E-BN065146X	Catalog 100	E-BN104042X	Catalog 100
E-823303X	Catalog 820	E-824106	Catalog 100	E-BN065154X	Catalog 100	E-BN104102X	Catalog 100
E-823304	Catalog 820	E88-1245A	Catalog 100	E-BN065156X	Catalog 100	E-BN104103X	Catalog 100
E-823304X	Catalog 820	E88-1245C	Catalog 100	E-BN065157X	Catalog 100	E-BN104165X	Catalog 100
E-823305	Catalog 820	E88-1307	Catalog 100	E-BN065225X	Catalog 100	E-BN104345X	Catalog 100
E-823305X	Catalog 820	E88-1308	Catalog 100	E-BN065313X	Catalog 100	E-BN104358X	Catalog 100
E-823400	Catalog 820	E88-1308A	Catalog 100	E-BN065395X	Catalog 100	E-BN104561X	Catalog 100
E-823400X	Catalog 820	E88-1308T	Catalog 100	E-BN065437X	Catalog 100	E-BN104583X	Catalog 100
E-823403	Catalog 820	E88-1443TT	Catalog 100	E-BN065438X	Catalog 100	E-BN104584X	Catalog 100
E-823403X	Catalog 820	E88-4223A	Catalog 100	E-BN065439X	Catalog 100	E-BN104598X	Catalog 100
E-823404X	Catalog 820	E88-4311G	Catalog 100	E-BN101100X	Catalog 100	E-BN104644X	Catalog 100
E-823405X	Catalog 820	E88-4311J	Catalog 100	E-BN101112X	Catalog 100	E-BN106268X	Catalog 100
E-823406X	Catalog 820	E88-4317G	Catalog 100	E-BN101135X	Catalog 100	E-BN106284X	Catalog 100
E-823407	Catalog 820	E88-4504A	Catalog 100	E-BN101142X	Catalog 100	E-BN106313X	Catalog 100
E-823407X	Catalog 820	E88-4515	Catalog 100	E-BN101158X	Catalog 100	E-BN106941X	Catalog 100
E-823408	Catalog 820	E88-4515E	Catalog 100	E-BN101242X	Catalog 100	E-BN107433X	Catalog 100
E-823408X	Catalog 820	E88-4515C	Catalog 100	E-BN101245X	Catalog 100	E-BN107506X	Catalog 100
E-823409	Catalog 820	E88-4515H	Catalog 100	E-BN101256X	Catalog 100	E-BN107507X	Catalog 100
E-823409X	Catalog 820	E88-4524B	Catalog 100	E-BN101282X	Catalog 100	E-BN107508X	Catalog 100
E-823410	Catalog 820	E88-4551B	Catalog 100	E-BN101311X	Catalog 100	E-BN107509X	Catalog 100
E-823410X	Catalog 820	E88-4591	Catalog 100	E-BN101333X	Catalog 100	E-BN107510X	Catalog 100
E-823411	Catalog 820	E88-4596	Catalog 100	E-BN101437X	Catalog 100	E-BN107511X	Catalog 100
E-823411X	Catalog 820	E88-4597	Catalog 100	E-BN101450X	Catalog 100	E-BN107512X	Catalog 100
E-823412	Catalog 820	E88-4649	Catalog 100	E-BN101569X	Catalog 100	E-BN107513X	Catalog 100
E-823412X	Catalog 820	E88-4692	Catalog 100	E-BN101570X	Catalog 100	E-BN107514X	Catalog 100
E-823413X	Catalog 820	E88-4693	Catalog 100	E-BN101590X	Catalog 100	E-BN107539X	Catalog 100
E-823415X	Catalog 820	E88-4702	Catalog 100	E-BN101622X	Catalog 100	E-BN107622X	Catalog 100
E-823416X	Catalog 820	E88-4707	Catalog 100	E-BN101636X	Catalog 100	E-BN107623X	Catalog 100
E-823417X	Catalog 820	E88-4708	Catalog 100	E-BN101786X	Catalog 100	E-BN107794X	Catalog 100
E-823419X	Catalog 820	E88-4709	Catalog 100	E-BN101818X	Catalog 100	E-BN107813X	Catalog 100
E-823420X	Catalog 820	E88-4715	Catalog 100	E-BN101900X	Catalog 100	E-BN107866X	Catalog 100
E-823500	Catalog 820	E98-4471A	Catalog 100	E-BN102213X	Catalog 100	E-BN107896X	Catalog 100
E-823500X	Catalog 820	E98-4471B	Catalog 100	E-BN102598X	Catalog 100	E-BN107917X	Catalog 100
E-823501	Catalog 820	E98-4515E	Catalog 100	E-BN102626N	Catalog 100	E-BN108066X	Catalog 100
E-823501X	Catalog 820	E98-4527B	Catalog 100	E-BN102626X	Catalog 100	E-BN108076X	Catalog 100
E-823502	Catalog 820	E98-4707	Catalog 100	E-BN102697X	Catalog 100	E-BN108110X	Catalog 100
E-823502X	Catalog 820	E-BC12S	Catalog 100	E-BN102734X	Catalog 100	E-BN108272X	Catalog 100
E-823503	Catalog 820	E-BC16S	Catalog 100	E-BN102742X	Catalog 100	E-BN108277X	Catalog 100
E-823503X	Catalog 820	E-BC2024C	Catalog 100	E-BN102761X	Catalog 100	E-BN108329X	Catalog 100
E-823504	Catalog 820	E-BC2024P	Catalog 100	E-BN102835X	Catalog 100	E-BN108866X	Catalog 100
E-823504X	Catalog 820	E-BC20S	Catalog 100	E-BN102952X	Catalog 100	E-BN109604X	Catalog 100
E-823505	Catalog 820	E-BC2424C	Catalog 100	E-BN102953X	Catalog 100	E-BN11892X	Catalog 200
E-823505X	Catalog 820	E-BC2424P	Catalog 100	E-BN102989X	Catalog 100	E-BN11908X	Catalog 200
E-823506	Catalog 820	E-BC2430C	Catalog 100	E-BN103009N	Catalog 100	E-BN11909X	Catalog 200
E-823506X	Catalog 820	E-BC2430C-L	Catalog 100	E-BN103009X	Catalog 100	E-BN11991X	Catalog 200
E-823600	Catalog 820	E-BC2430P	Catalog 100	E-BN103010N	Catalog 100	E-BN11992X	Catalog 200
E-823601	Catalog 820	E-BC24S	Catalog 100	E-BN103010X	Catalog 100	E-BN11993X	Catalog 200
E-823601X	Catalog 820	E-BC24S-L	Catalog 100	E-BN103028N	Catalog 100	E-BN11994X	Catalog 200
E-823602	Catalog 820	E-BC3030C	Catalog 100	E-BN103028X	Catalog 100	E-BN11995X	Catalog 200
E-823602X	Catalog 820	E-BC3030C-C	Catalog 100	E-BN103061X	Catalog 100	E-BN11998X	Catalog 200
E-823603	Catalog 820	E-BC3030P	Catalog 100	E-BN103081X	Catalog 100	E-BN11999X	Catalog 200
E-823603X	Catalog 820	E-BC3036C	Catalog 100	E-BN103139X	Catalog 100	E-BN223578X	Catalog 100
		E-BC3036P	Catalog 100	E-BN103195X	Catalog 100	E-BN225892X	Catalog 100

MASTER PART NUMBER INDEX

Part No	Page	Part No	Page	Part No	Page	Part No	Page
E-BN227320X	Catalog 100	E-BN229844X	Catalog 100	E-BN2515074X	Catalog 200	E-BN278598X	Catalog 100
E-BN227321X	Catalog 100	E-BN229859N	Catalog 100	E-BN2515075X	Catalog 200	E-BN278604X	Catalog 100
E-BN227322X	Catalog 100	E-BN229859X	Catalog 100	E-BN2518644X	Catalog 200	E-BN278605X	Catalog 100
E-BN227323X	Catalog 100	E-BN229860N	Catalog 100	E-BN275231X	Catalog 100	E-BN278606X	Catalog 100
E-BN227325X	Catalog 100	E-BN229860X	Catalog 100	E-BN275317X	Catalog 100	E-BN278614X	Catalog 100
E-BN227326X	Catalog 100	E-BN229990X	Catalog 100	E-BN275491N	Catalog 100	E-BN278615X	Catalog 100
E-BN227327X	Catalog 100	E-BN2500397X	Catalog 200	E-BN275491X	Catalog 100	E-BN278646X	Catalog 100
E-BN227328X	Catalog 100	E-BN2500517X	Catalog 200	E-BN275509X	Catalog 100	E-BN278825X	Catalog 100
E-BN227331X	Catalog 100	E-BN2500660X	Catalog 200	E-BN275725X	Catalog 100	E-BN278998X	Catalog 100
E-BN227332X	Catalog 100	E-BN2501001X	Catalog 200	E-BN275777X	Catalog 100	E-BN279000N	Catalog 100
E-BN227355X	Catalog 100	E-BN2501424X	Catalog 200	E-BN275834X	Catalog 100	E-BN279000X	Catalog 100
E-BN227356X	Catalog 100	E-BN2502703X	Catalog 200	E-BN275990X	Catalog 100	E-BN279024X	Catalog 100
E-BN227357X	Catalog 100	E-BN2503258X	Catalog 200	E-BN276111X	Catalog 100	E-BN279025X	Catalog 100
E-BN227361X	Catalog 100	E-BN2503259X	Catalog 200	E-BN276166X	Catalog 100	E-BN279040X	Catalog 100
E-BN227400X	Catalog 100	E-BN2504102X	Catalog 200	E-BN276270X	Catalog 100	E-BN279069X	Catalog 100
E-BN227401X	Catalog 100	E-BN2504105X	Catalog 200	E-BN276272X	Catalog 100	E-BN279072X	Catalog 100
E-BN227402X	Catalog 100	E-BN2504106X	Catalog 200	E-BN276462X	Catalog 100	E-BN279074X	Catalog 100
E-BN227403X	Catalog 100	E-BN2504113X	Catalog 200	E-BN276566N	Catalog 100	E-BN279176X	Catalog 100
E-BN227404X	Catalog 100	E-BN2504187X	Catalog 200	E-BN276566X	Catalog 100	E-BN279180N	Catalog 100
E-BN227406X	Catalog 100	E-BN2504188X	Catalog 200	E-BN276567N	Catalog 100	E-BN279180X	Catalog 100
E-BN227407X	Catalog 100	E-BN2504303X	Catalog 200	E-BN276567X	Catalog 100	E-BN279252X	Catalog 100
E-BN227408X	Catalog 100	E-BN2508065X	Catalog 200	E-BN276635X	Catalog 100	E-BN279384X	Catalog 100
E-BN227409X	Catalog 100	E-BN2508177X	Catalog 200	E-BN276777X	Catalog 100	E-BN279416N	Catalog 100
E-BN227410X	Catalog 100	E-BN2509140X	Catalog 200	E-BN276778X	Catalog 100	E-BN279525X	Catalog 100
E-BN227415X	Catalog 100	E-BN2509426X	Catalog 200	E-BN276961X	Catalog 100	E-BN279556X	Catalog 100
E-BN227661X	Catalog 100	E-BN2509870X	Catalog 200	E-BN276962X	Catalog 100	E-BN279580X	Catalog 100
E-BN227672X	Catalog 100	E-BN2510401X	Catalog 200	E-BN276971X	Catalog 100	E-BN279589X	Catalog 100
E-BN227870N	Catalog 100	E-BN2510555X	Catalog 200	E-BN276974X	Catalog 100	E-BN279614	Catalog 100
E-BN227871N	Catalog 100	E-BN2510665	Catalog 200	E-BN276978X	Catalog 100	E-BN279615	Catalog 100
E-BN228050X	Catalog 100	E-BN2510665X	Catalog 200	E-BN2770433X	Catalog 200	E-BN279662X	Catalog 100
E-BN228138X	Catalog 100	E-BN2511065	Catalog 200	E-BN2771117X	Catalog 200	E-BN279692X	Catalog 100
E-BN228141X	Catalog 100	E-BN2512059X	Catalog 200	E-BN277122X	Catalog 100	E-BN279707X	Catalog 100
E-BN228165X	Catalog 100	E-BN2512060X	Catalog 200	E-BN2771250X	Catalog 200	E-BN279750X	Catalog 100
E-BN228344X	Catalog 100	E-BN2512061X	Catalog 200	E-BN277127X	Catalog 100	E-BN279762X	Catalog 100
E-BN228346X	Catalog 100	E-BN2512062X	Catalog 200	E-BN277144X	Catalog 100	E-BN279787X	Catalog 100
E-BN228366X	Catalog 100	E-BN2512063X	Catalog 200	E-BN277147X	Catalog 100	E-BN279790X	Catalog 100
E-BN228429X	Catalog 100	E-BN2512064X	Catalog 200	E-BN277148X	Catalog 100	E-BN279824X	Catalog 100
E-BN228430X	Catalog 100	E-BN2512065X	Catalog 200	E-BN2771494	Catalog 200	E-BN279838X	Catalog 100
E-BN228443X	Catalog 100	E-BN2512066X	Catalog 200	E-BN2771494X	Catalog 200	E-BN279839X	Catalog 100
E-BN228451X	Catalog 100	E-BN2512076X	Catalog 200	E-BN2771552X	Catalog 200	E-BN279950X	Catalog 100
E-BN228479X	Catalog 100	E-BN2512138SBX	Catalog 200	E-BN2771558X	Catalog 200	E-BN279952X	Catalog 100
E-BN228520X	Catalog 100	E-BN2512138X	Catalog 200	E-BN2771559X	Catalog 200	E-BN279962X	Catalog 100
E-BN228600N	Catalog 100	E-BN2512139X	Catalog 200	E-BN277214X	Catalog 100	E-BN279995X	Catalog 100
E-BN228600X	Catalog 100	E-BN2512140X	Catalog 200	E-BN277222X	Catalog 100	E-BN280238X	Catalog 100
E-BN228750N	Catalog 100	E-BN2512142X	Catalog 200	E-BN277226X	Catalog 100	E-BN280243X	Catalog 100
E-BN228750X	Catalog 100	E-BN2512569X	Catalog 200	E-BN277227X	Catalog 100	E-BN280280X	Catalog 100
E-BN228762X	Catalog 100	E-BN2512570X	Catalog 200	E-BN277340X	Catalog 100	E-BN280369X	Catalog 100
E-BN229078X	Catalog 100	E-BN2512620X	Catalog 200	E-BN277446X	Catalog 100	E-BN280375X	Catalog 100
E-BN229154X	Catalog 100	E-BN2513173X	Catalog 200	E-BN277694X	Catalog 100	E-BN280422X	Catalog 100
E-BN229434X	Catalog 100	E-BN2513174X	Catalog 200	E-BN277730X	Catalog 100	E-BN280446X	Catalog 100
E-BN229467X	Catalog 100	E-BN2513175X	Catalog 200	E-BN277731X	Catalog 100	E-BN280453X	Catalog 100
E-BN229493X	Catalog 100	E-BN2513177X	Catalog 200	E-BN277855X	Catalog 100	E-BN280454X	Catalog 100
E-BN229500X	Catalog 100	E-BN2513494X	Catalog 200	E-BN277863N	Catalog 100	E-BN280501X	Catalog 100
E-BN229501X	Catalog 100	E-BN2513813X	Catalog 200	E-BN277863X	Catalog 100	E-BN280526X	Catalog 100
E-BN229505X	Catalog 100	E-BN2513814X	Catalog 200	E-BN277901X	Catalog 100	E-BN280540X	Catalog 100
E-BN229507X	Catalog 100	E-BN2513815X	Catalog 200	E-BN277920X	Catalog 100	E-BN280551X	Catalog 100
E-BN229509X	Catalog 100	E-BN2514916X	Catalog 200	E-BN278425X	Catalog 100	E-BN280556X	Catalog 100
E-BN229525X	Catalog 100	E-BN2514917X	Catalog 200	E-BN278426X	Catalog 100	E-BN280570X	Catalog 100
E-BN229544X	Catalog 100	E-BN2514918X	Catalog 200	E-BN278445X	Catalog 100	E-BN280602X	Catalog 100
E-BN229562X	Catalog 100	E-BN2514919X	Catalog 200	E-BN278452X	Catalog 100	E-BN280603X	Catalog 100
E-BN229608X	Catalog 100	E-BN2514920X	Catalog 200	E-BN278482X	Catalog 100	E-BN280604X	Catalog 100
E-BN229635N	Catalog 100	E-BN2515029X	Catalog 200	E-BN278483X	Catalog 100	E-BN280605X	Catalog 100
E-BN229635X	Catalog 100	E-BN2515030X	Catalog 200	E-BN278596X	Catalog 100	E-BN280608X	Catalog 100
E-BN229813X	Catalog 100	E-BN2515050X	Catalog 200	E-BN278597X	Catalog 100	E-BN280609X	Catalog 100

MASTER PART NUMBER INDEX

Part No	Page	Part No	Page	Part No	Page	Part No	Page
E-BN374980X	Catalog 200	E-D529-S	Catalog 200	E-GP3636	Catalog 100	E-MDEL13080X	Catalog 100
E-BN375278X	Catalog 200	E-D557-48	Catalog 200	E-KH5453X	Catalog 100	E-MDEL13081X	Catalog 100
E-BN375279X	Catalog 200	E-D557-S	Catalog 200	E-KH5454X	Catalog 100	E-MDEL13090X	Catalog 100
E-BN376500X	Catalog 200	E-D591-S	Catalog 200	E-KH5455X	Catalog 100	E-MDEL13100X	Catalog 100
E-BN379900X	Catalog 200	E-D624-S	Catalog 200	E-KH5459X	Catalog 100	E-MDEL13111X	Catalog 100
E-CU3047440X	Catalog 100	E-D632-S	Catalog 200	E-KH5460X	Catalog 100	E-MDEL13120X	Catalog 100
E-CU3049186X	Catalog 100	E-D646-S	Catalog 200	E-KH5461X	Catalog 100	E-MDEL13151X	Catalog 100
E-CU3559511	Catalog 100	E-D652-S	Catalog 200	E-KH5462X	Catalog 100	E-MDEL13160X	Catalog 100
E-D120-48	Catalog 200	E-D654-S	Catalog 200	E-KH5468X	Catalog 100	E-MDEL13200X	Catalog 100
E-D120-S	Catalog 200	E-D655-48	Catalog 200	E-KH5470X	Catalog 100	E-MDEL14110X	Catalog 100
E-D149-48	Catalog 200	E-D655-S	Catalog 200	E-LC3030	Catalog 100	E-MDEL14111X	Catalog 100
E-D149-S	Catalog 200	E-D667-S	Catalog 200	E-LP3030	Catalog 100	E-MDEL16020X	Catalog 100
E-D153-48	Catalog 200	E-D675-S	Catalog 200	E-MD12345X	Catalog 100	E-MDEL16040X	Catalog 100
E-D154-48	Catalog 200	E-D679-S	Catalog 200	E-MD12346X	Catalog 100	E-MDEL16050X	Catalog 100
E-D154-S	Catalog 200	E-D702-S	Catalog 200	E-MD12360X	Catalog 100	E-MDEL16051X	Catalog 100
E-D171-S	Catalog 200	E-D711-S	Catalog 200	E-MD12361X	Catalog 100	E-MDEL16053X	Catalog 100
E-D184-48	Catalog 200	E-D715-S	Catalog 200	E-MDC14285VG	Catalog 200	E-MDEL16060X	Catalog 100
E-D215-48	Catalog 200	E-D726-S	Catalog 200	E-MDC3400X	Catalog 200	E-MDEL16100X	Catalog 100
E-D215-S	Catalog 200	E-D729-S	Catalog 200	E-MDC3462X	Catalog 200	E-MDEL16110X	Catalog 100
E-D224-48	Catalog 200	E-D756-S	Catalog 200	E-MDC3472X	Catalog 200	E-MDEL16111X	Catalog 100
E-D224-S	Catalog 200	E-D757-S	Catalog 200	E-MDC3492X	Catalog 200	E-MDEL16120X	Catalog 100
E-D225-48	Catalog 200	E-D758-S	Catalog 200	E-MDC3496X	Catalog 200	E-MDEL16200X	Catalog 100
E-D225-S	Catalog 200	E-D769-S	Catalog 200	E-MDC3500SEX	Catalog 200	E-MDEL16250X	Catalog 100
E-D225-SHD	Catalog 200	E-D777-S	Catalog 200	E-MDC3500SFX	Catalog 200	E-MDKN18011X	Catalog 100
E-D236-48	Catalog 200	E-D786-S	Catalog 200	E-MDC3502SBX	Catalog 200	E-MDKN18511X	Catalog 100
E-D236-S	Catalog 200	E-D786A-S	Catalog 200	E-MDC3503SXX	Catalog 200	E-MDKN18530X	Catalog 100
E-D249-48	Catalog 200	E-DE18001047X	Catalog 200	E-MDC3507SBX	Catalog 200	E-MDKN18531X	Catalog 100
E-D259-S	Catalog 200	E-DE18001072X	Catalog 200	E-MDC3510SAX	Catalog 200	E-MDKN20000X	Catalog 100
E-D267	Catalog 200	E-DE18001810X	Catalog 200	E-MDC4003X	Catalog 200	E-MDKN20010X	Catalog 100
E-D269-48	Catalog 200	E-DE18003144X	Catalog 200	E-MDC4007X	Catalog 200	E-MDKN20020X	Catalog 100
E-D269-S	Catalog 200	E-DE18003998X	Catalog 200	E-MDC4021X	Catalog 200	E-MDKN20030AX	Catalog 100
E-D326-S	Catalog 200	E-DE18006974X	Catalog 200	E-MDC4034X	Catalog 200	E-MDKN20030X	Catalog 100
E-D344-S	Catalog 200	E-DE18014080X	Catalog 200	E-MDC4035X	Catalog 200	E-MDKN20040X	Catalog 100
E-D368-48	Catalog 200	E-FU16743N	Catalog 100	E-MDC4036X	Catalog 200	E-MDKN20050X	Catalog 100
E-D368-S	Catalog 200	E-FU16859N	Catalog 100	E-MDC4037X	Catalog 200	E-MDKN20060X	Catalog 100
E-D369-48	Catalog 200	E-FU19974N	Catalog 100	E-MDC4042X	Catalog 200	E-MDKN20070X	Catalog 100
E-D369-S	Catalog 200	E-FUA3546N	Catalog 100	E-MDC4044X	Catalog 200	E-MDKN20071X	Catalog 100
E-D370-48	Catalog 200	E-FUA3546X	Catalog 100	E-MDC4055X	Catalog 200	E-MDKN20080X	Catalog 100
E-D370-S	Catalog 200	E-FUA3547X	Catalog 100	E-MDC4056X	Catalog 200	E-MDKN20090X	Catalog 100
E-D375-48	Catalog 200	E-FUA3991X	Catalog 100	E-MDC4057X	Catalog 200	E-MDKN20110X	Catalog 100
E-D375-S	Catalog 200	E-FUA4487N	Catalog 100	E-MDC4058X	Catalog 200	E-MDKN20561X	Catalog 100
E-D379-S	Catalog 200	E-FUA4490N	Catalog 100	E-MDC4083X	Catalog 200	E-MDKN20562X	Catalog 100
E-D380-48	Catalog 200	E-FUA4491N	Catalog 100	E-MDC4085X	Catalog 200	E-MDKN20570X	Catalog 100
E-D380-S	Catalog 200	E-FUA4688N	Catalog 100	E-MDC4089X	Catalog 200	E-MDKN20580X	Catalog 100
E-D380-SHD	Catalog 200	E-FUA4688X	Catalog 100	E-MDC4090X	Catalog 200	E-MDKN20581X	Catalog 100
E-D387-S	Catalog 200	E-FUA4900N	Catalog 100	E-MDC448X	Catalog 200	E-MDKN20590X	Catalog 100
E-D392-S	Catalog 200	E-FUA5010N	Catalog 100	E-MDC462X	Catalog 200	E-MDKN20615X	Catalog 100
E-D411-48	Catalog 200	E-FUA5015N	Catalog 100	E-MDC464X	Catalog 200	E-MDKN22100X	Catalog 100
E-D411-S	Catalog 200	E-GC2024	Catalog 100	E-MDC468BX	Catalog 200	E-MDKN22140X	Catalog 100
E-D416-S	Catalog 200	E-GC2424	Catalog 100	E-MDC468CX	Catalog 200	E-MDKN22150X	Catalog 100
E-D433-S	Catalog 200	E-GC2424-LS	Catalog 100	E-MDC4702X	Catalog 200	E-MDKN24000X	Catalog 100
E-D442-S	Catalog 200	E-GC2430	Catalog 100	E-MDC472X	Catalog 200	E-MDKN24001X	Catalog 100
E-D450-48	Catalog 200	E-GC2430-LS	Catalog 100	E-MDC479X	Catalog 200	E-MDKN26000N	Catalog 100
E-D450-S	Catalog 200	E-GC3030	Catalog 100	E-MDC490BX	Catalog 200	E-MDKN26000X	Catalog 100
E-D459-S	Catalog 200	E-GC3036	Catalog 100	E-MDC490GX	Catalog 200	E-MDKN26010X	Catalog 100
E-D494-S	Catalog 200	E-GC3636	Catalog 100	E-MDEL13020X	Catalog 100	E-MDKN28010X	Catalog 100
E-D50-48	Catalog 200	E-GP1624	Catalog 100	E-MDEL13021X	Catalog 100	E-MDKN28011X	Catalog 100
E-D50-S	Catalog 200	E-GP2024	Catalog 100	E-MDEL13022X	Catalog 100	E-MDKN28030X	Catalog 100
E-D505-S	Catalog 200	E-GP2424	Catalog 100	E-MDEL13040X	Catalog 100	E-MDKN28060N	Catalog 100
E-D52-48	Catalog 200	E-GP2424-LS	Catalog 100	E-MDEL13050X	Catalog 100	E-MDKN28060X	Catalog 100
E-D52-S	Catalog 200	E-GP2430	Catalog 100	E-MDEL13051X	Catalog 100	E-MDKN28061X	Catalog 100
E-D521-S	Catalog 200	E-GP2430-LS	Catalog 100	E-MDEL13053X	Catalog 100	E-MDKN28065X	Catalog 100
E-D522-S	Catalog 200	E-GP3030	Catalog 100	E-MDEL13060X	Catalog 100	E-MDKN28071X	Catalog 100
E-D524-S	Catalog 200	E-GP3036	Catalog 100	E-MDEL13070X	Catalog 100	E-MDKN28080X	Catalog 100

MASTER PART NUMBER INDEX

Part No	Page	Part No	Page	Part No	Page	Part No	Page
E-MDKN28085X	Catalog 100	E-MDT33C	Catalog 100	E-RA33072	Catalog 100	E-SL110130	Catalog 100
E-MDKN28130X	Catalog 100	E-PB0912	Catalog 100	E-RA33096	Catalog 100	E-SL110131	Catalog 100
E-MDKN28131X	Catalog 100	E-PB0916	Catalog 100	E-RA34218	Catalog 100	E-SL110139	Catalog 100
E-MDKN28132X	Catalog 100	E-PB1212	Catalog 100	E-RA34430	Catalog 100	E-SL110139X	Catalog 100
E-MDKN28140X	Catalog 100	E-PB1216	Catalog 100	E-RA34560	Catalog 100	E-SL110143	Catalog 100
E-MDKN28300X	Catalog 100	E-RA10204	Catalog 100	E-RA34970	Catalog 100	E-SL110146	Catalog 100
E-MDKN28500N	Catalog 100	E-RA10234	Catalog 100	E-RA38220A	Catalog 100	E-SL110156	Catalog 100
E-MDKN28500X	Catalog 100	E-RA10236	Catalog 100	E-RA39036A	Catalog 100	E-SL110158	Catalog 100
E-MDKN28510N	Catalog 100	E-RA10237A	Catalog 100	E-RA40082	Catalog 100	E-SL110162	Catalog 100
E-MDKN28510X	Catalog 100	E-RA10242	Catalog 100	E-RA40083	Catalog 100	E-SL110165	Catalog 100
E-MDKN28520N	Catalog 100	E-RA10248	Catalog 100	E-RA40134A	Catalog 100	E-SL110166	Catalog 100
E-MDKN28520X	Catalog 100	E-RA10459	Catalog 100	E-RA40230	Catalog 100	E-SL110167	Catalog 100
E-MDKN28600N	Catalog 100	E-RA10468A	Catalog 100	E-RA40300	Catalog 100	E-SL110170	Catalog 100
E-MDKN28600X	Catalog 100	E-RA10469A	Catalog 100	E-RA40449	Catalog 100	E-SL110170X	Catalog 100
E-MDKN28601X	Catalog 100	E-RA10470A	Catalog 100	E-RA40560A	Catalog 100	E-SL110171	Catalog 100
E-MDKN30010NX	Catalog 100	E-RA10503	Catalog 100	E-RA40563A	Catalog 100	E-SL110171X	Catalog 100
E-MDKN30010X	Catalog 100	E-RA10507	Catalog 100	E-RA40586	Catalog 100	E-SL110174	Catalog 100
E-MDKN30100X	Catalog 100	E-RA10559	Catalog 100	E-RA40653B	Catalog 100	E-SL110175	Catalog 100
E-MDKN30200X	Catalog 100	E-RA10587	Catalog 100	E-RA41099	Catalog 100	E-SL110176	Catalog 100
E-MDKN30300X	Catalog 100	E-RA10596	Catalog 100	E-RA41255	Catalog 100	E-SL110183	Catalog 100
E-MDKN30400X	Catalog 100	E-RA10698	Catalog 100	E-RA41620	Catalog 100	E-SL110185	Catalog 100
E-MDKN31000X	Catalog 100	E-RA10778	Catalog 100	E-RA41640	Catalog 100	E-SL110189	Catalog 100
E-MDKN31010X	Catalog 100	E-RA10861	Catalog 100	E-RA42533	Catalog 100	E-SL110191	Catalog 100
E-MDKN31020X	Catalog 100	E-RA10945	Catalog 100	E-RA60072	Catalog 100	E-SL110191X	Catalog 100
E-MDKN31030X	Catalog 100	E-RA10972B	Catalog 100	E-RA61072	Catalog 100	E-SL110195	Catalog 100
E-MDKN31050X	Catalog 100	E-RA10987	Catalog 100	E-RA61096	Catalog 100	E-SL110197	Catalog 100
E-MDKN31060X	Catalog 100	E-RA10994	Catalog 100	E-RA62096	Catalog 100	E-SL110197X	Catalog 100
E-MDKN31070X	Catalog 100	E-RA11742	Catalog 100	E-RA63072	Catalog 100	E-SL110198X	Catalog 100
E-MDKN31080X	Catalog 100	E-RA11794	Catalog 100	E-RA63096	Catalog 100	E-SL110199X	Catalog 100
E-MDKN32000X	Catalog 100	E-RA11795	Catalog 100	E-RA68172A	Catalog 100	E-SL110200	Catalog 100
E-MDKN32010X	Catalog 100	E-RA13061	Catalog 100	E-RA68196A	Catalog 100	E-SL110200X	Catalog 100
E-MDKN32020X	Catalog 100	E-RA13204	Catalog 100	E-RA68220A	Catalog 100	E-SL110201	Catalog 100
E-MDKN32030X	Catalog 100	E-RA14401	Catalog 100	E-RA68236A	Catalog 100	E-SL110205	Catalog 100
E-MDKN32040X	Catalog 100	E-RA14650	Catalog 100	E-RA68260A	Catalog 100	E-SL110205X	Catalog 100
E-MDKN32041X	Catalog 100	E-RA14830A	Catalog 100	E-RA68272A	Catalog 100	E-SL110207	Catalog 100
E-MDKN34030X	Catalog 100	E-RA15195	Catalog 100	E-RA68296A	Catalog 100	E-SL110227	Catalog 100
E-MDKN34040X	Catalog 100	E-RA15234	Catalog 100	E-RA68320A	Catalog 100	E-SL110228	Catalog 100
E-MDKN34050X	Catalog 100	E-RA15400	Catalog 100	E-RA68336A	Catalog 100	E-SL110237	Catalog 100
E-MDKN34060X	Catalog 100	E-RA15434	Catalog 100	E-RA68372A	Catalog 100	E-SL110238	Catalog 100
E-MDKN34070X	Catalog 100	E-RA15495	Catalog 100	E-RA68396A	Catalog 100	E-SL110241	Catalog 100
E-MDKN34080X	Catalog 100	E-RA15554	Catalog 100	E-RA69036A	Catalog 100	E-SL110242	Catalog 100
E-MDKN34090X	Catalog 100	E-RA15600	Catalog 100	E-RA69072A	Catalog 100	E-SL110250	Catalog 100
E-MDKN35010X	Catalog 200	E-RA16503	Catalog 100	E-RA69096A	Catalog 100	E-SL110252	Catalog 100
E-MDKN35020X	Catalog 200	E-RA16600	Catalog 100	E-SL10-5	Catalog 100	E-SL110257	Catalog 100
E-MDKN68230N	Catalog 100	E-RA17105	Catalog 100	E-SL1000-3	Catalog 100	E-SL110258	Catalog 100
E-MDKN68237N	Catalog 100	E-RA17130	Catalog 100	E-SL1000-5A	Catalog 100	E-SL110274	Catalog 100
E-MDKN7000X	Catalog 100	E-RA17495	Catalog 100	E-SL1000-5AX	Catalog 100	E-SL110275	Catalog 100
E-MDKN7010X	Catalog 100	E-RA17630	Catalog 100	E-SL1000-7	Catalog 100	E-SL110284	Catalog 100
E-MDKN7020X	Catalog 100	E-RA17663	Catalog 100	E-SL1000-8	Catalog 100	E-SL110285	Catalog 100
E-MDKN7030X	Catalog 100	E-RA18019	Catalog 100	E-SL1000-9	Catalog 100	E-SL110290	Catalog 100
E-MDKN7040X	Catalog 100	E-RA18021	Catalog 100	E-SL10200-1/2	Catalog 100	E-SL110296	Catalog 100
E-MDKN7041X	Catalog 100	E-RA18052A	Catalog 100	E-SL10200-3/4	Catalog 100	E-SL110297	Catalog 100
E-MDKN7050X	Catalog 100	E-RA18059	Catalog 100	E-SL103-5	Catalog 100	E-SL110300	Catalog 100
E-MDKN7060X	Catalog 100	E-RA18065	Catalog 100	E-SL10300-12	Catalog 100	E-SL110301	Catalog 100
E-MDKN7070X	Catalog 100	E-RA18132	Catalog 100	E-SL109-5	Catalog 100	E-SL110310X	Catalog 100
E-MDKN7080X	Catalog 100	E-RA18143	Catalog 100	E-SL10900	Catalog 100	E-SL110314	Catalog 100
E-MDKN7170X	Catalog 100	E-RA18190A	Catalog 100	E-SL110005	Catalog 100	E-SL110315X	Catalog 100
E-MDKN7180X	Catalog 100	E-RA18191A	Catalog 100	E-SL110103	Catalog 100	E-SL110329	Catalog 100
E-MDKN85020X	Catalog 100	E-RA18401	Catalog 100	E-SL110114	Catalog 100	E-SL110338	Catalog 100
E-MDKN86020X	Catalog 100	E-RA18514	Catalog 100	E-SL110118	Catalog 100	E-SL110338X	Catalog 100
E-MDKN86230X	Catalog 100	E-RA31072	Catalog 100	E-SL110124	Catalog 100	E-SL110358	Catalog 100
E-MDRNT26A	Catalog 100	E-RA31096	Catalog 100	E-SL110127	Catalog 100	E-SL110359	Catalog 100
E-MDRNT26JB	Catalog 100	E-RA31300	Catalog 100	E-SL110128	Catalog 100	E-SL110360	Catalog 100
E-MDRNT33C	Catalog 100	E-RA32072	Catalog 100	E-SL110129	Catalog 100	E-SL110360X	Catalog 100

MASTER PART NUMBER INDEX

Part No	Page	Part No	Page	Part No	Page	Part No	Page
E-SL110365	Catalog 100	E-SL140200	Catalog 100	E-SL340250	Catalog 100	E-SL8000B	Catalog 100
E-SL110365X	Catalog 100	E-SL140201	Catalog 100	E-SL340350	Catalog 100	E-SL8022	Catalog 100
E-SL110376	Catalog 100	E-SL140270	Catalog 100	E-SL342500	Catalog 100	E-SL8023	Catalog 100
E-SL110376X	Catalog 100	E-SL140271	Catalog 100	E-SL342501	Catalog 100	E-SL8098	Catalog 100
E-SL110380	Catalog 100	E-SL140280	Catalog 100	E-SL342502	Catalog 100	E-SL81-5	Catalog 100
E-SL110380X	Catalog 100	E-SL140281	Catalog 100	E-SL345000	Catalog 100	E-SL8100	Catalog 100
E-SL110384	Catalog 100	E-SL140290	Catalog 100	E-SL3450G	Catalog 100	E-SL8100B	Catalog 100
E-SL110385X	Catalog 100	E-SL140370	Catalog 100	E-SL3450S	Catalog 100	E-SL8116	Catalog 100
E-SL110390	Catalog 100	E-SL140380	Catalog 100	E-SL3800	Catalog 100	E-SL819	Catalog 100
E-SL110395	Catalog 100	E-SL140390	Catalog 100	E-SL501T	Catalog 100	E-SL821	Catalog 100
E-SL110400X	Catalog 100	E-SL14900	Catalog 100	E-SL503	Catalog 100	E-SL900	Catalog 100
E-SL110410	Catalog 100	E-SL15-5	Catalog 100	E-SL509	Catalog 100	E-SL91-5	Catalog 100
E-SL110410X	Catalog 100	E-SL1500	Catalog 100	E-SL517	Catalog 100	E-SL9125	Catalog 100
E-SL110412	Catalog 100	E-SL150100	Catalog 100	E-SL52-5	Catalog 100	E-SL9125-5	Catalog 100
E-SL110412X	Catalog 100	E-SL150105	Catalog 100	E-SL5200	Catalog 100	E-SL9125X	Catalog 100
E-SL110415	Catalog 100	E-SL176-5	Catalog 100	E-SL5400	Catalog 100	E-SL94-5	Catalog 100
E-SL110415X	Catalog 100	E-SL17600	Catalog 100	E-SL59-5	Catalog 100	E-SL9400	Catalog 100
E-SL110416	Catalog 100	E-SL17600B	Catalog 100	E-SL5900	Catalog 100	E-SL9400-5	Catalog 100
E-SL110416X	Catalog 100	E-SL17600B-2	Catalog 100	E-SL5900-1	Catalog 100	E-SL940000	Catalog 100
E-SL110425X	Catalog 100	E-SL17600C	Catalog 100	E-SL5900-5	Catalog 100	E-SL996-5	Catalog 100
E-SL110430X	Catalog 100	E-SL17600C-2	Catalog 100	E-SL5900B	Catalog 100	E-SL99600	Catalog 100
E-SL110435	Catalog 100	E-SL17600L	Catalog 100	E-SL5900G	Catalog 100	E-SL99600-5	Catalog 100
E-SL110440X	Catalog 100	E-SL17600L-2	Catalog 100	E-SL5900GI	Catalog 100	E-SL99600B	Catalog 100
E-SL110445X	Catalog 100	E-SL17600LB	Catalog 100	E-SL5900L	Catalog 100	E-SL99600BL	Catalog 100
E-SL110450X	Catalog 100	E-SL17600LB-2	Catalog 100	E-SL5900R	Catalog 100	E-SLA1000S	Catalog 100
E-SL110459X	Catalog 100	E-SL17600LG	Catalog 100	E-SL6002	Catalog 100	E-SLA1000SX	Catalog 100
E-SL110460X	Catalog 100	E-SL17600LR	Catalog 100	E-SL6003	Catalog 100	E-SLA1100	Catalog 100
E-SL110470	Catalog 100	E-SL17600M	Catalog 100	E-SL6006	Catalog 100	E-SLA256-5	Catalog 100
E-SL110470X	Catalog 100	E-SL17600M-2	Catalog 100	E-SL6010	Catalog 100	E-SLA25600	Catalog 100
E-SL110471	Catalog 100	E-SL18600	Catalog 100	E-SL6011	Catalog 100	E-SLA25600-2	Catalog 100
E-SL110475	Catalog 100	E-SL18900	Catalog 100	E-SL6012	Catalog 100	E-SLA25600Y	Catalog 100
E-SL110475X	Catalog 100	E-SL20-5	Catalog 100	E-SL6125	Catalog 100	E-SN401004	Catalog 100
E-SL110500	Catalog 100	E-SL200000	Catalog 100	E-SL6125-2	Catalog 100	E-SN401018	Catalog 100
E-SL110500X	Catalog 100	E-SL200001	Catalog 100	E-SL6125-25	Catalog 100	E-SN401019	Catalog 100
E-SL110507	Catalog 100	E-SL200002	Catalog 100	E-SL6125-2X	Catalog 100	E-SN401029	Catalog 100
E-SL110515	Catalog 100	E-SL200003	Catalog 100	E-SL6125-35	Catalog 100	E-SN401037X	Catalog 100
E-SL110520	Catalog 100	E-SL200004	Catalog 100	E-SL6125-40	Catalog 100	E-SN401040	Catalog 100
E-SL110542	Catalog 100	E-SL2000B1/2	Catalog 100	E-SL6125-45	Catalog 100	E-SN401045	Catalog 100
E-SL110544	Catalog 100	E-SL2000B3/8	Catalog 100	E-SL6125-5	Catalog 100	E-SN401046	Catalog 100
E-SL110555	Catalog 100	E-SL2000C1/2	Catalog 100	E-SL6125-7	Catalog 100	E-SN401047	Catalog 100
E-SL110570	Catalog 100	E-SL2000C3/8	Catalog 100	E-SL616	Catalog 100	E-SN401056	Catalog 100
E-SL110570X	Catalog 100	E-SL2000D1/2	Catalog 100	E-SL617	Catalog 100	E-SN401075	Catalog 100
E-SL110580	Catalog 100	E-SL2000D3/8	Catalog 100	E-SL63-5	Catalog 100	E-SN401084	Catalog 100
E-SL110580X	Catalog 100	E-SL200125	Catalog 100	E-SL6300	Catalog 100	E-SN401095	Catalog 100
E-SL110584X	Catalog 100	E-SL20D-5	Catalog 100	E-SL6300-5	Catalog 100	E-WAA103600X	Catalog 100
E-SL110609	Catalog 100	E-SL21600	Catalog 100	E-SL6300H	Catalog 100	E-WAA80070X	Catalog 100
E-SL110690X	Catalog 100	E-SL21600-2	Catalog 100	E-SL663-5	Catalog 100	E-WAA80150X	Catalog 100
E-SL110700	Catalog 100	E-SL21600D	Catalog 100	E-SL69-5	Catalog 100	E-WAA83034X	Catalog 100
E-SL110700X	Catalog 100	E-SL216050	Catalog 100	E-SL6900	Catalog 100	E-WAA85490X	Catalog 100
E-SL110705	Catalog 100	E-SL216200	Catalog 100	E-SL6900-5	Catalog 100	E-WAA85493X	Catalog 100
E-SL110742	Catalog 100	E-SL220000	Catalog 100	E-SL690200	Catalog 100	E-WAA86473X	Catalog 100
E-SL110744	Catalog 100	E-SL22001/2	Catalog 100	E-SL7023	Catalog 100	E-WAA86477X	Catalog 100
E-SL110790X	Catalog 100	E-SL22001/4	Catalog 100	E-SL7040	Catalog 100	E-WAA88802X	Catalog 100
E-SL110800	Catalog 100	E-SL22003/4	Catalog 100	E-SL72-5	Catalog 100	E-WAA88812X	Catalog 100
E-SL11900	Catalog 100	E-SL220100	Catalog 100	E-SL7200	Catalog 100	E-WAA97600X	Catalog 100
E-SL13	Catalog 100	E-SL2550	Catalog 100	E-SL757	Catalog 100	E-WAA98730X	Catalog 100
E-SL1300	Catalog 100	E-SL29	Catalog 100	E-SL77-5	Catalog 100	E-WAA99370X	Catalog 100
E-SL1300-45	Catalog 100	E-SL31-5	Catalog 100	E-SL7700	Catalog 100	E-WAF76178S	Catalog 200
E-SL1300-80	Catalog 100	E-SL3100	Catalog 100	E-SL78-5	Catalog 100	E-TR5050-08	Catalog 700
E-SL13G	Catalog 100	E-SL3100-5	Catalog 100	E-SL7800	Catalog 100	E-TR5050-10	Catalog 700
E-SL13R	Catalog 100	E-SL3100X	Catalog 100	E-SL780210	Catalog 100	E-TR5050-12	Catalog 700
E-SL13S	Catalog 100	E-SL32-5	Catalog 100	E-SL780212	Catalog 100	E-TR5050-14	Catalog 700
E-SL13Y	Catalog 100	E-SL3200	Catalog 100	E-SL80-5	Catalog 100	E-TR5050-16	Catalog 700
E-SL140105	Catalog 100	E-SL320100	Catalog 100	E-SL8000	Catalog 100	E-TR5050-18	Catalog 700

MASTER PART NUMBER INDEX

Part No	Page	Part No	Page	Part No	Page	Part No	Page
E-TR5050-20	Catalog 700	E-TR8075-48	Catalog 700	E-UB8143-074	Catalog 700	E-UB8264-12	Catalog 700
E-TR5050-22	Catalog 700	E-TR8075-50	Catalog 700	E-UB8145-076	Catalog 700	E-UB8264-14	Catalog 700
E-TR5050-24	Catalog 700	E-TR8075-52	Catalog 700	E-UB8151-10	Catalog 700	E-UB8264-16	Catalog 700
E-TR5050-26	Catalog 700	E-TR8087-18	Catalog 700	E-UB8151-12	Catalog 700	E-UB8265-084	Catalog 700
E-TR5050-28	Catalog 700	E-TR8087-20	Catalog 700	E-UB8151-14	Catalog 700	E-UB8265-16	Catalog 700
E-TR5050-30	Catalog 700	E-TR8087-22	Catalog 700	E-UB8151-16	Catalog 700	E-UB8267-153	Catalog 700
E-TR5050-32	Catalog 700	E-TR8087-24	Catalog 700	E-UB8151-18	Catalog 700	E-UB8286-134	Catalog 700
E-TR5050-34	Catalog 700	E-TR8087-26	Catalog 700	E-UB8151-22	Catalog 700	E-UB8286-154	Catalog 700
E-TR5050-36	Catalog 700	E-TR8087-28	Catalog 700	E-UB8153-10	Catalog 700	E-UB8287-11	Catalog 700
E-TR5056-08	Catalog 700	E-TR8087-30	Catalog 700	E-UB8153-12	Catalog 700	E-UB8287-14	Catalog 700
E-TR5056-10	Catalog 700	E-TR8087-32	Catalog 700	E-UB8153-14	Catalog 700	E-UB8351-18	Catalog 700
E-TR5056-12	Catalog 700	E-TR8087-34	Catalog 700	E-UB8153-18	Catalog 700	E-UB8353-10	Catalog 700
E-TR5056-14	Catalog 700	E-TR8087-36	Catalog 700	E-UB8154-10	Catalog 700	E-UB8353-12	Catalog 700
E-TR5056-16	Catalog 700	E-TR8087-38	Catalog 700	E-UB8154-12	Catalog 700	E-UB8353-15	Catalog 700
E-TR5056-18	Catalog 700	E-TR8087-40	Catalog 700	E-UB8154-18	Catalog 700	E-UB8354-10	Catalog 700
E-TR5056-20	Catalog 700	E-TR8087-42	Catalog 700	E-UB8155-073	Catalog 700	E-UB8354-12	Catalog 700
E-TR5056-22	Catalog 700	E-TR8087-44	Catalog 700	E-UB8155-12	Catalog 700	E-UB8362-19F	Catalog 700
E-TR5056-24	Catalog 700	E-TR8087-46	Catalog 700	E-UB8155-14	Catalog 700	E-UB8363-15N	Catalog 700
E-TR5056-26	Catalog 700	E-TR8087-48	Catalog 700	E-UB8155-16	Catalog 700	E-UB8375-14	Catalog 700
E-TR5056-28	Catalog 700	E-TR8087-50	Catalog 700	E-UB8161-10	Catalog 700	E-UB8375-154	Catalog 700
E-TR5056-30	Catalog 700	E-TR8087-52	Catalog 700	E-UB8161-11	Catalog 700	E-UB8394-144	Catalog 700
E-TR5056-32	Catalog 700	E-TR8100-16	Catalog 700	E-UB8161-12	Catalog 700	E-UB8394-162S	Catalog 700
E-TR5056-34	Catalog 700	E-TR8100-20	Catalog 700	E-UB8161-122	Catalog 700	E-UB8394-172S	Catalog 700
E-TR5056-36	Catalog 700	E-TR8100-24	Catalog 700	E-UB8161-13	Catalog 700	E-UB8394-18	Catalog 700
E-TR5056-38	Catalog 700	E-TR8100-28	Catalog 700	E-UB8161-14	Catalog 700	E-UB8394-192S	Catalog 700
E-TR5056-40	Catalog 700	E-TR8100-32	Catalog 700	E-UB8161-15	Catalog 700	E-UB8396-165S	Catalog 700
E-TR5056-42	Catalog 700	E-TR8100-36	Catalog 700	E-UB8161-16	Catalog 700	E-UB8475-114	Catalog 700
E-TR8062-12	Catalog 700	E-TR8100-40	Catalog 700	E-UB8161-17	Catalog 700	E-UB8479-090	Catalog 700
E-TR8062-14	Catalog 700	E-TR8100-44	Catalog 700	E-UB8161-18	Catalog 700	E-UB8479-104	Catalog 700
E-TR8062-16	Catalog 700	E-TR8100-48	Catalog 700	E-UB8161-18S1	Catalog 700	E-UB8479-124	Catalog 700
E-TR8062-18	Catalog 700	E-TR8112-30	Catalog 700	E-UB8161-20	Catalog 700	E-UB8554-033	Catalog 700
E-TR8062-20	Catalog 700	E-TR8112-32	Catalog 700	E-UB8161-22	Catalog 700	E-UB8575-126	Catalog 700
E-TR8062-22	Catalog 700	E-TR8112-34	Catalog 700	E-UB8162-18	Catalog 700	E-UB8578-094	Catalog 700
E-TR8062-24	Catalog 700	E-TR8112-36	Catalog 700	E-UB8162-22	Catalog 700	E-UB8578-124	Catalog 700
E-TR8062-26	Catalog 700	E-TR8112-38	Catalog 700	E-UB8162-14	Catalog 700	E-UB8585-132	Catalog 700
E-TR8062-28	Catalog 700	E-TR8125-30	Catalog 700	E-UB8163-16	Catalog 700	E-UB8673-154	Catalog 700
E-TR8062-30	Catalog 700	E-TR8125-32	Catalog 700	E-UB8164-10	Catalog 700		
E-TR8062-32	Catalog 700	E-TR8125-34	Catalog 700	E-UB8164-12	Catalog 700		
E-TR8062-34	Catalog 700	E-TR8125-36	Catalog 700	E-UB8164-16	Catalog 700		
E-TR8062-36	Catalog 700	E-TR8125-38	Catalog 700	E-UB8164-18	Catalog 700		
E-TR8062-38	Catalog 700	E-UB5161-12	Catalog 700	E-UB8165-076	Catalog 700		
E-TR8062-40	Catalog 700	E-UB5161-13	Catalog 700	E-UB8165-10	Catalog 700		
E-TR8062-42	Catalog 700	E-UB5161-14	Catalog 700	E-UB8165-12	Catalog 700		
E-TR8062-44	Catalog 700	E-UB5161-15	Catalog 700	E-UB8165-13	Catalog 700		
E-TR8062-46	Catalog 700	E-UB5161-16	Catalog 700	E-UB8165-14	Catalog 700		
E-TR8062-48	Catalog 700	E-UB5161-18	Catalog 700	E-UB8165-16	Catalog 700		
E-TR8075-12	Catalog 700	E-UB5161-22	Catalog 700	E-UB8165-18	Catalog 700		
E-TR8075-14	Catalog 700	E-UB5163-14	Catalog 700	E-UB8166-12	Catalog 700		
E-TR8075-16	Catalog 700	E-UB5163-18	Catalog 700	E-UB8168-082	Catalog 700		
E-TR8075-18	Catalog 700	E-UB5165-12	Catalog 700	E-UB8175-104	Catalog 700		
E-TR8075-20	Catalog 700	E-UB5165-14	Catalog 700	E-UB8178-126	Catalog 700		
E-TR8075-22	Catalog 700	E-UB5165-15	Catalog 700	E-UB8179-09	Catalog 700		
E-TR8075-24	Catalog 700	E-UB5165-16	Catalog 700	E-UB8187-154	Catalog 700		
E-TR8075-26	Catalog 700	E-UB5165-18	Catalog 700	E-UB8253-05	Catalog 700		
E-TR8075-28	Catalog 700	E-UB5243-16	Catalog 700	E-UB8253-12	Catalog 700		
E-TR8075-30	Catalog 700	E-UB5243-18	Catalog 700	E-UB8254-10	Catalog 700		
E-TR8075-32	Catalog 700	E-UB5243-20	Catalog 700	E-UB8254-12	Catalog 700		
E-TR8075-34	Catalog 700	E-UB5244-16	Catalog 700	E-UB8254-14	Catalog 700		
E-TR8075-36	Catalog 700	E-UB5244-18	Catalog 700	E-UB8255-05	Catalog 700		
E-TR8075-38	Catalog 700	E-UB5244-20	Catalog 700	E-UB8256-077	Catalog 700		
E-TR8075-40	Catalog 700	E-UB5261-18	Catalog 700	E-UB8261-18	Catalog 700		
E-TR8075-42	Catalog 700	E-UB5263-14	Catalog 700	E-UB8263-14	Catalog 700		
E-TR8075-44	Catalog 700	E-UB5263-18	Catalog 700	E-UB8264-083	Catalog 700		
E-TR8075-46	Catalog 700	E-UB8142-06	Catalog 700	E-UB8264-10	Catalog 700		

WARRANTY AND DISCLAIMERS OF WARRANTIES

The following warranty applies to all Euclid Brand Products except remanufactured air compressors, starters, alternators, and water pumps and some specialized product lines (air springs, shock absorbers, manual and automatic slack adjusters, air conditioning compressors and compressor clutches) that carry only the warranty of the Original Equipment Manufacturer.

Euclid Industries, LLC warrants to Warehouse Distributor that all merchandise will be free from defects in material and workmanship under normal and proper usage for a period of 2 years from the date of shipment by Euclid Industries, LLC or 90 days from the date of sale by Warehouse Distributor, whichever is less. This warranty does not cover and Euclid Industries, LLC makes no warranty with respect to (i) any merchandise that is abused, misused, misapplied, neglected or altered; or that is improperly or incorrectly installed or maintained or used; or that is subjected to abnormal conditions of use, temperature, moisture, dirt or corrosive matter; and (ii) any merchandise, materials, parts or other components supplied by someone other than Euclid Industries, LLC.

THIS WARRANTY IS EXCLUSIVE AND IN LIEU OF ALL OTHER WARRANTIES, WHETHER EXPRESS, IMPLIED OR OTHERWISE ARISING BY OPERATION OF LAW, TRADE, USAGE OR COURSE OF DEALING, INCLUDING WITHOUT LIMITATION, THE IMPLIED WARRANTIES OF MERCHANTABILITY AND FITNESS FOR A PARTICULAR PURPOSE.

Warehouse Distributor must provide Euclid Industries, LLC with written notice of any breach of the warranty within 30 days after Warehouse Distributor discovers, or should have discovered, the alleged breach. Time is of the essence, and Warehouse Distributor's failure to provide such written notice to Euclid Industries, LLC within this 30-day period will fully and completely release Euclid Industries, LLC from any obligation or liability for that breach of warranty. This warranty extends only to Warehouse Distributor and to no other persons.

REMEDIES AND LIMITATION OF LIABILITY

In the event of any material breach of the warranty set forth above, Euclid Industries, LLC, at its sole option, will credit Warehouse Distributor's account, repair any defective parts or furnish replacement merchandise (F.O.B. Euclid's plant), all subject to Warehouse Distributor providing the required written notice within the 30-day period set forth above. Any action against Euclid Industries, LLC must be commenced within 1 year after the alleged cause of action arises.

No employee or agent of Euclid Industries, LLC is authorized to make any additional warranty or offer any additional remedy, or to alter or vary the terms of the warranty or any disclaimers of warranties or limitations of liability contained herein.

THESE REMEDIES ARE THE SOLE AND EXCLUSIVE REMEDIES AVAILABLE TO WAREHOUSE DISTRIBUTOR SO THAT EUCLID INDUSTRIES, LLC'S CREDIT TO WAREHOUSE DISTRIBUTOR'S ACCOUNT, REPAIR OR REPLACEMENT OF PARTS IS A FULFILLMENT OF ALL EUCLID INDUSTRIES, LLC'S OBLIGATIONS. EUCLID INDUSTRIES, LLC IS NOT LIABLE FOR ANY INCIDENTAL OR CONSEQUENTIAL DAMAGES OF ANY KIND, NOR UNDER ANY CIRCUMSTANCES WILL EUCLID INDUSTRIES, LLC BE LIABLE FOR DAMAGES BEYOND THE PRICE OF THE DEFECTIVE PARTS, WHETHER IN CONTRACT, IN TORT OR UNDER ANY WARRANTY OR OTHER USE.

ArvinMeritor

Euclid Industries, LLC

6660 Beta Drive, Cleveland, Ohio 44143-2321
1-866-2Euclid

Euclid Industries Canada Ltd.

Toronto • Edmonton • Montreal

www.arvinmeritor.com
www.xpresswayplus.com

© Copyright 2002
ArvinMeritor, Inc.

Litho in U.S.A.

Issued 11-02
760C